

REL-PR3- 24DC/3X21 - Single relay



2903702

<https://www.phoenixcontact.com/us/products/2903702>

Please be informed that the data shown in this PDF document is generated from our online catalog. Please find the complete data in the user documentation. Our general terms of use for downloads are valid.

Plug-in high-power relay with power contacts, 3 changeover contacts, coil voltage: 24 V DC



Commercial data

Item number	2903702
Packing unit	1 pc
Minimum order quantity	1 pc
Sales key	C460
Product key	CK6193
Catalog page	Page 312 (C-5-2019)
GTIN	4046356759144
Weight per piece (including packing)	86.2 g
Weight per piece (excluding packing)	86.2 g
Customs tariff number	85364190
Country of origin	PL

REL-PR3- 24DC/3X21 - Single relay



2903702

<https://www.phoenixcontact.com/us/products/2903702>

Technical data

Notes

General	The outputs are not suitable for switching different outer conductors.
General	Do not use to separate SELV / PELV circuits from other circuits, because safe isolation is not guaranteed.

Product properties

Product type	Single relay
Operating mode	100% operating factor
Mechanical service life	approx. 10^7 cycles

Insulation characteristics

Insulation	Basic insulation
------------	------------------

Insulation characteristics

Insulation	Basic insulation
Overvoltage category	III
Pollution degree	3

Electrical properties

Service life electrical	see diagram
Maximum power dissipation for nominal condition	1.34 W
Test voltage (Winding/contact)	2.5 kV _{rms} (50 Hz, 1 min., winding/contact)
Test voltage (Changeover contact/changeover contact)	2.5 kV _{rms} (50 Hz, 1 min., changeover contact/changeover contact)
Rated insulation voltage	250 V AC
Rated surge voltage	4 kV

Input data

Coil side

Nominal input voltage U_N	24 V DC
Input voltage range	20.4 V DC ... 26.4 V DC (see diagram)
Drive and function	monostable
Drive (polarity)	non-polarized
Typical input current at U_N	56 mA
Input power dissipation for U_N	1.35 W
Typical response time	20 ms
Typical release time	15 ms
Coil resistance	430 Ω \pm 10 %

Output data

Switching

REL-PR3- 24DC/3X21 - Single relay



2903702

<https://www.phoenixcontact.com/us/products/2903702>

Contact switching type	3 changeover contacts
Type of switch contact	Single contact
Contact material	AgNi
Maximum switching voltage	440 V AC 250 V DC
Minimum switching voltage	10 V (At 24 mA)
Limiting continuous current	16 A
Maximum inrush current	50 A (20 ms, N/O contacts)
Min. switching current	10 mA (at 24 V)
Interrupting rating (ohmic load) max.	384 W (at 24 V DC) 124 W (at 48 V DC) 108 W (at 60 V DC) 52 W (at 110 V DC) 70 W (at 220 V DC) 4000 VA (for 250 V AC) 4000 VA (at 440 V AC)
3-phase motor load	1500 W (at 400 V, AC3)
Motor load according to UL 508	1/3 HP, 120 V AC (single-phase AC motor) 1/2 HP, 240 V AC (single-phase AC motor) 1/2 HP, 240 V AC (three-phase induction motor)

Connection data

Connection method	Plug-in connection
-------------------	--------------------

Dimensions

Width	38.6 mm
Height	36.1 mm
Depth	45.5 mm

Environmental and real-life conditions

Ambient conditions

Degree of protection	RT I
Degree of protection (Installation location)	≥ IP54 (Installation location)
Ambient temperature (operation)	-40 °C ... 70 °C
Ambient temperature (storage/transport)	-40 °C ... 85 °C
Altitude	≤ 2000 m

Approvals

Corrosive gas test

Identification	ISA-S71.04. G3 Harsh Group EN 60068-2-60
----------------	---

Standards and regulations

Standards/regulations	IEC 60664
-----------------------	-----------

REL-PR3- 24DC/3X21 - Single relay



2903702

<https://www.phoenixcontact.com/us/products/2903702>

	IEC 61810
--	-----------

Mounting

Mounting position	any
-------------------	-----

Drawings

Diagram

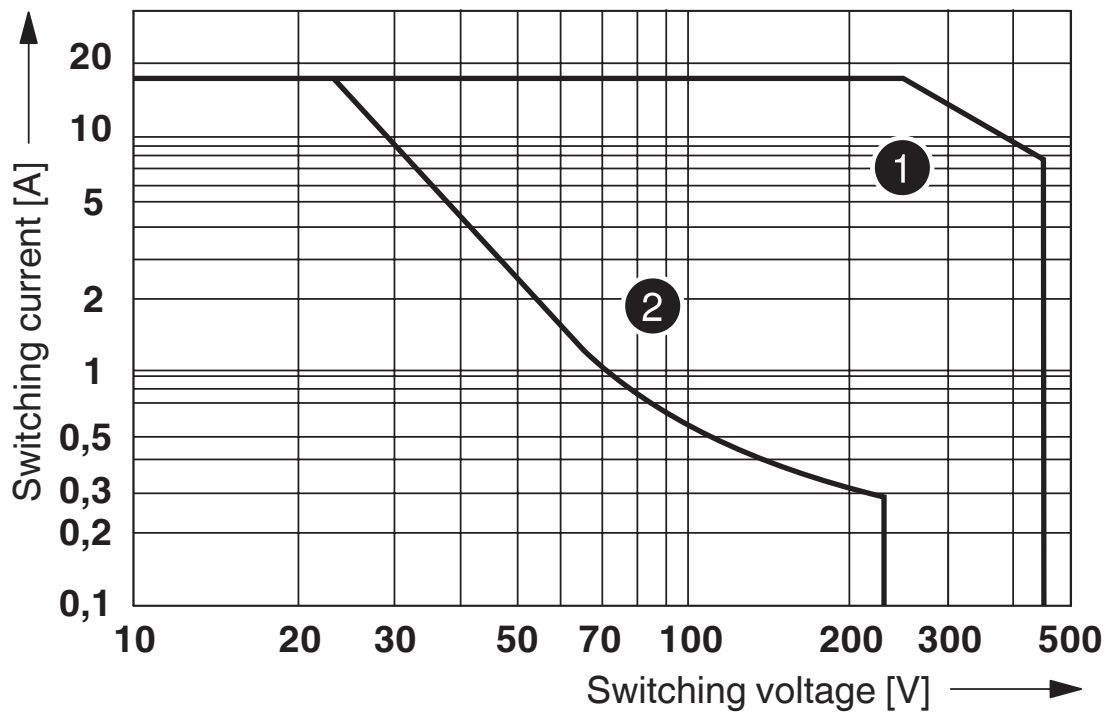

① AC, ohmic load

② DC, ohmic load

Interrupting rating

Circuit diagram

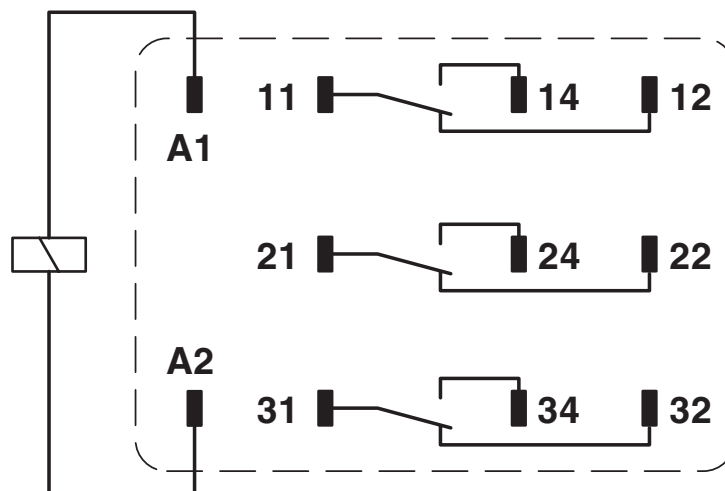

Diagram

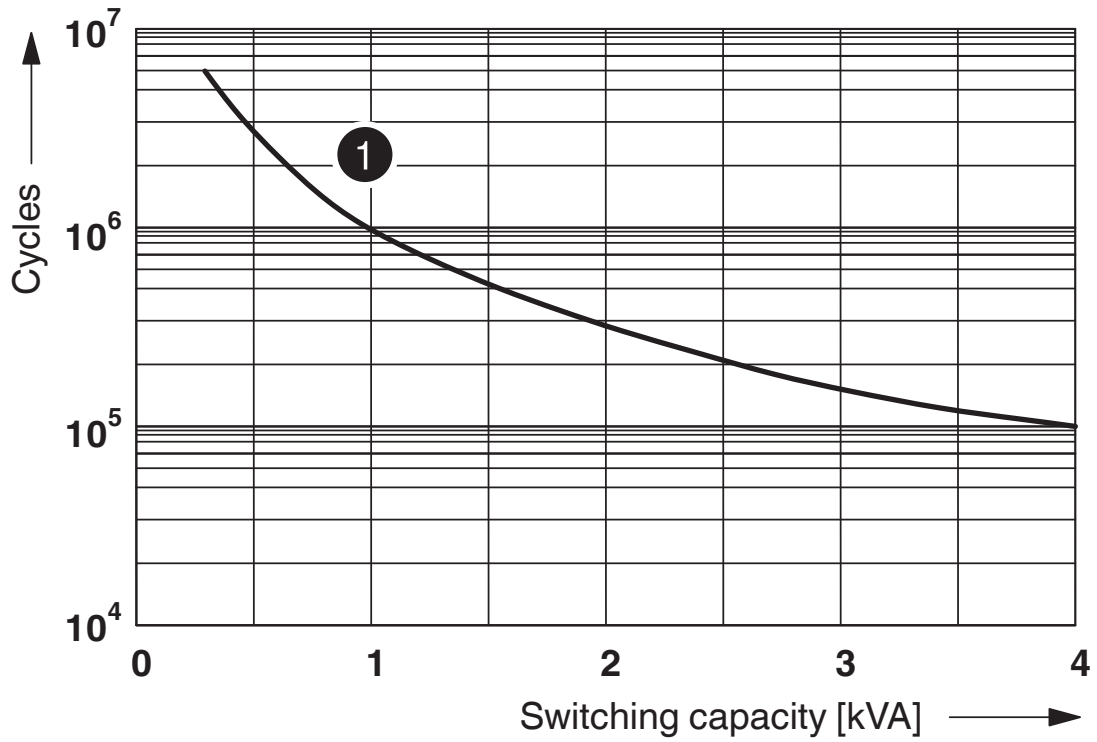

① 250 V AC, Ohmic load

Electrical service life

REL-PR3- 24DC/3X21 - Single relay



2903702

<https://www.phoenixcontact.com/us/products/2903702>

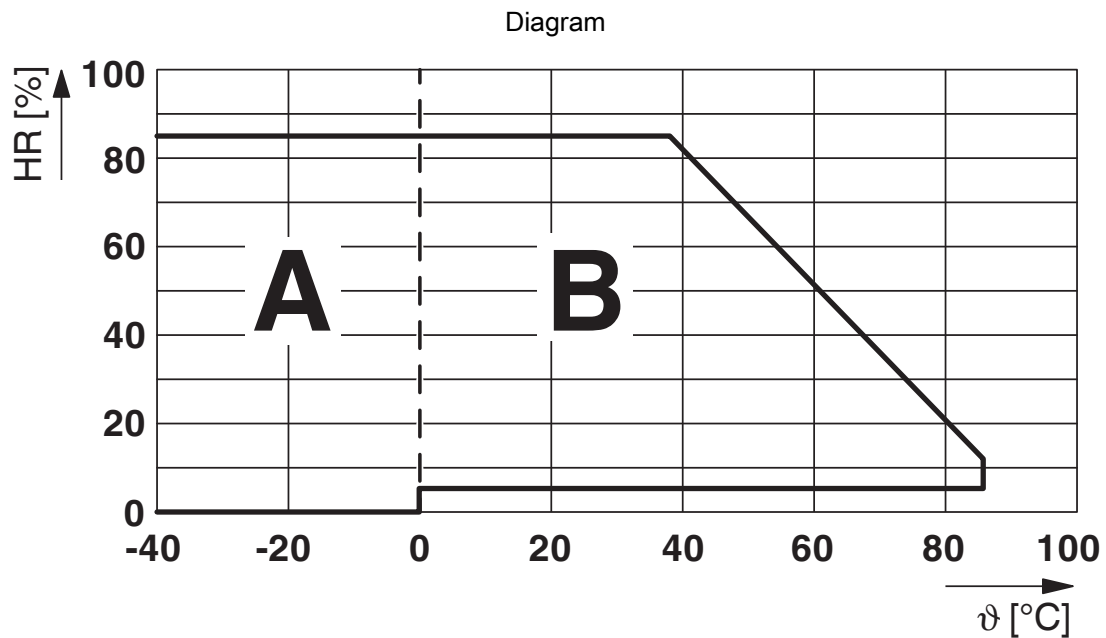

Permissible humidity for operation and storage.

The maximum permissible ambient temperature as specified in the data sheet must be observed.

Area A: Ice buildup at ambient temperatures $\leq 0^{\circ}\text{C}$ must be prevented

Area B: Condensation at ambient temperatures $> 0^{\circ}\text{C}$ must be prevented

On 30 full days that are naturally distributed across an entire year, a humidity level of 95% is permissible at an ambient temperature $\leq 25^{\circ}\text{C}$.

Diagram

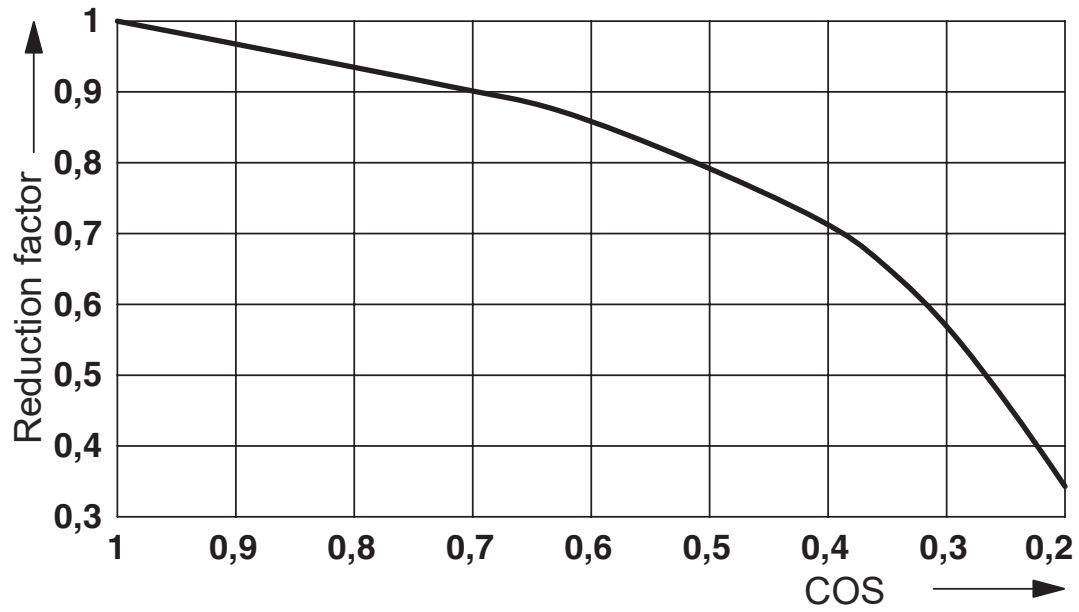

Service life reduction factor

REL-PR3- 24DC/3X21 - Single relay

2903702

<https://www.phoenixcontact.com/us/products/2903702>

Diagram

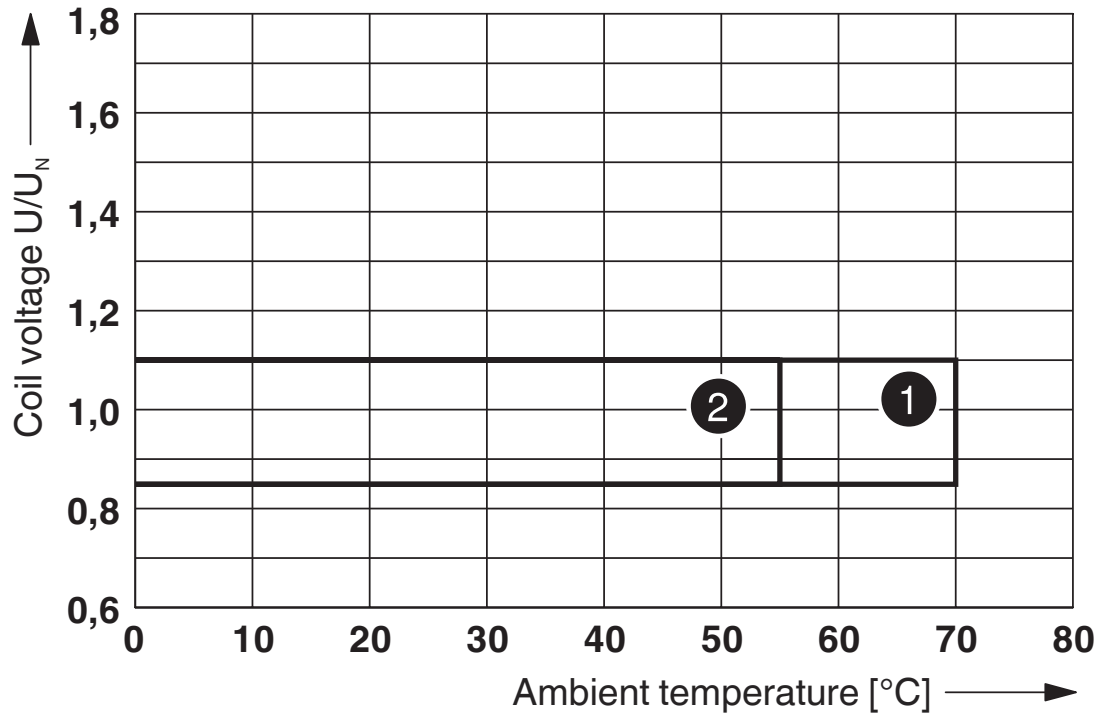

- ① DC coils
- ② AC coils

Operating voltage range

REL-PR3- 24DC/3X21 - Single relay



2903702

<https://www.phoenixcontact.com/us/products/2903702>

Approvals

To download certificates, visit the product detail page: <https://www.phoenixcontact.com/us/products/2903702>



CSA

Approval ID: 256725



cUL Recognized

Approval ID: FILE E 172140



UL Recognized

Approval ID: FILE E 172140



EAC

Approval ID: TR_TS_D_00573_c

cULus Recognized

REL-PR3- 24DC/3X21 - Single relay



2903702

<https://www.phoenixcontact.com/us/products/2903702>

Classifications

ECLASS

ECLASS-11.0	27371601
ECLASS-12.0	27371601
ECLASS-13.0	27371601

ETIM

ETIM 8.0	EC001437
----------	----------

UNSPSC

UNSPSC 21.0	39122300
-------------	----------

REL-PR3- 24DC/3X21 - Single relay



2903702

<https://www.phoenixcontact.com/us/products/2903702>

Environmental product compliance

China RoHS	Environmentally friendly use period: unlimited = EFUP-e
	No hazardous substances above threshold values

REL-PR3- 24DC/3X21 - Single relay



2903702

<https://www.phoenixcontact.com/us/products/2903702>

Mandatory accessories

RIF-4-BPT/3X21 - Relay base

2900961

<https://www.phoenixcontact.com/us/products/2900961>

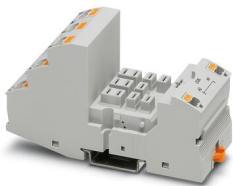

Relay base RIF-4..., for high-power relay with 2 or 3 changeover contacts or 3 N/O contacts, Push-in connection, plug-in option for input/interference suppression modules, for mounting on NS 35/7,5

RIF-4-BSC/3X21 - Relay base

2900960

<https://www.phoenixcontact.com/us/products/2900960>

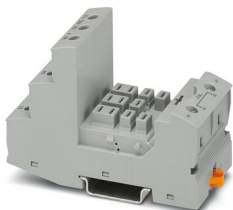

RIF-4... relay base, for high-power relay with 2 or 3 changeover contacts or 3 N/O contacts, screw connection, plug-in option for input/interference suppression modules, for mounting on NS 35/7,5

Phoenix Contact 2023 © - all rights reserved

<https://www.phoenixcontact.com>

Phoenix Contact USA
586 Fulling Mill Road
Middletown, PA 17057, United States
(+717) 944-1300
info@phoenixcon.com