



MPX Series
MIL-DTL-83527B
AECMA EN3682



Contents

Introduction	5-4
Applications	5-4
Product overview	5-5
Technical characteristics	5-6
Shell ordering information	5-8
Insert ordering information	5-9
Connector ordering information	5-10
Insert combination code	5-11
Inserts layouts cavities A, C, or E	5-14
Inserts layouts cavities B, D, or F	5-18
Modification code	5-21
Polarization code	5-22
Contacts	5-23
Accessories	5-33
Dimensions	
- Shell 2 dimensions	5-35
- Shell 3 dimensions	5-38
- Shell 4 dimensions	5-40
Panel cut-out	5-42
Part numbers index	5-44

SECTION 5 TABLE OF CONTENTS

MPX SERIES

Introduction

The Radiall MPX series is a robust rectangular connector designed to meet all the requirements of the MIL-DTL-83527B specification. The design conforms to the EN 3682 European Standard as well. This series is well suited for military and commercial aircraft applications where harsh environmental issues are a concern. Connectors, shells, inserts termination modules and contacts are sold separately or fully assembled.

Applications

These connectors are used to form the mechanical and electrical interface between the avionics equipment box and the rack.



Product Overview

Detailed view of the various parts of an MPX connector.

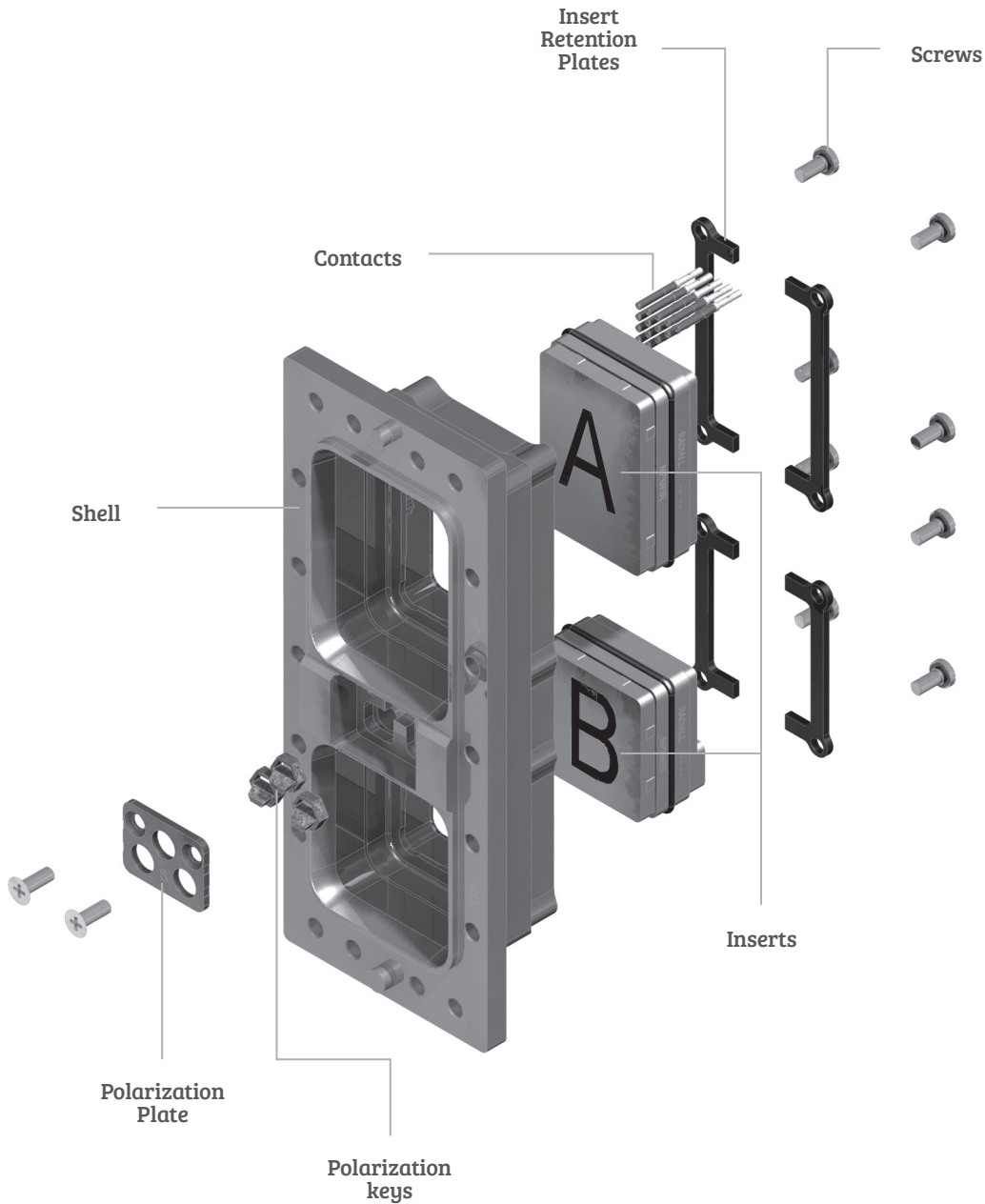

MPX SERIES

Technical Characteristics

ELECTRICAL

- Insulation resistance (Test procedure 21 of EIA364) : $\geq 1000M\Omega - 500Vdc$
- Shell to shell conductivity (Test procedure 83 of EIA364): $\leq 2.5m\Omega$
- Size 8 grounding (Test procedure 83 of EIA364): $\leq 10m\Omega$

DIELECTRIC WITHSTANDING VOLTAGE

(Test procedure 20 of EIA364): (Vrms)

Contact sizes	At sea level	Altitude (1.1 k Pa)
# 22	1 300	800
Other contacts	1 500	800

EMI SHIELDING EFFECTIVENESS
(MIL-DTL-83527B)

Frequency (Mhz)	Attenuation (dB)
100	65
200	65
300	63
400	62
800	60
1000	60

CONTACTS RESISTANCE (Test procedure 23 and 06 of EIA364)

Contact size	Wire			Max current (A)	Contact resistance (mΩ)
	AWG	Cross section (mm ²)	Min diameter inch (mm)		
22	22	0.38	.030 (0.76)	5	17
	24	0.21		3	23
	26	0.14		2	38
20	20	0.60	.035 (0.89)	7.5	11
	22	0.38		5	17
	24	0.21		3	23
16	16	1.34	.048 (1.21)	13	6
	18	0.91		10	8
	20	0.60		7.5	10
12	12	3.18	.091 (4.85)	23	3.35
	14	1.91		17	4.24

MECHANICAL & ENVIRONMENTAL

- Temperature range: 65°C (-85°F) to +150°C (+302°F)
- Temperature life : (see MIL-DTL-83527B): 1000 hours at 150°C (+302°F)
- Salt spray (Test procedure 26 of EIA364): 500 hours
- Humidity (Test procedure 31 of EIA364): 10 days
- Shock (Test procedure 27 of EIA364): 30g / 11ms / half sine
- Vibration: see MIL-DTL-83527B
- Mating & unmating: (Test procedure 9 of EIA364): 500 cycles
- Mating & unmating forces: Shell size 2 1446 N / 325 lbf max
Shell size 3 1780 N / 400 lbf max
Shell size 4 2113 N / 475 lbf max

MATERIALS

Description	Material	Finish
shell and backshell	aluminium alloy	cadmium yellow chromate over electroless nickel
contacts	copper alloy	gold over electroless nickel
inserts	thermosetting resin	/
	high grade thermoplastic	/
	aluminium	cadmium yellow chromate over electroless nickel
retention clip	copper alloy	/
seals and o-ring	fluorinated silicon rubber	/
insert retention plate	aluminium alloy	blue anodized
polarization key	zinc alloy	cadmium olive drab
polarization post	aluminium alloy	cadmium yellow chromate
screws	brass	cadmium yellow chromate
washers	copper alloy	cadmium yellow chromate
EMI spring	copper alloy & fluorinated silicon rubber	tin-lead alloy over electroless nickel

Technical Characteristics

MASSES

RECEPTACLE SHELLS

Receptacle g (oz)		
Shell size 2	Shell size 3	Shell size 4
160 [5.64]	240 [8.47]	335 [11.82]

PLUG SHELLS

Plug g (oz)		
Shell size 2	Shell size 3	Shell size 4
165 [5.82]	245 [8.64]	342 [12.06]

INSERTS

Description	Insert for plug shell g (oz)	Insert for receptacle shell g (oz)
MPXE2*T6	44 [1.55]	26 [0.92]
MPXE2*11T2	41 [1.45]	25 [0.88]
MPXE2*11C2	41 [1.45]	25 [0.88]
MPXE2*20T4	37 [1.31]	22 [0.78]
MPXE2*34	44 [1.55]	27 [0.95]
MPXE2*62T2	34 [1.20]	22 [0.78]
MPXE2*100	25 [0.88]	21 [0.74]
MPXE1*24	51 [1.80]	31 [1.10]
MPXE1*C12T6	55 [1.94]	33 [1.17]
MPXE1*47T2	57 [2.01]	35 [1.24]
MPXE1*60	63 [2.23]	39 [1.38]
MPXE1*126	47 [1.66]	31 [1.10]
MPXE1*150	41 [1.45]	27 [0.95]

CONTACTS

Contact size	Pin g (oz)	Socket g (oz)
22	0.12 [0.0043]	0.15 [0.0053]
20	0.22 [0.0078]	0.37 [0.0130]
16	0.73 [0.0258]	0.75 [0.0265]
12	1.50 [0.0530]	1.45 [0.0512]
8	1.10 [0.036]	3.80 [0.124]

Shell Information

The MPX shells are machined from solid aluminium alloy and have a good conductive and high resistance to corrosion thanks to cadmium yellow chromate plating.

There are 3 shell sizes which can respectively receive 2,4 and 6 inserts.

The plug shell is designed to be fitted with inserts for size 22 pin contacts and inserts for socket contacts for all other contact sizes. The plug shell has a field replaceable EMI spring and a coupling seal on each shell cavity and 3 polarization posts.

The receptacle shell is designed to be fitted with inserts for size 22 socket contacts and inserts for pin contacts for the other contact sizes. The receptacle shell has 3 polarization keys.

Plug and receptacle can be either front or rear mounted.



HOW TO ORDER SHELLS

	MPX	3	R	00	01
--	-----	---	---	----	----

Series _____
MPX connector

Shell size _____
 2 - 2 Cavities
 3 - 4 Cavities
 4 - 6 Cavities

Shell type _____
 R - Receptacle shell
 A - Plug shell

Modification code _____
 Refer to page 5-21

Polarization code _____
Blank - Polarization device delivered unassembled
00 - Polarizing keys or posts are not delivered
Other - please refer to page 5-22

How to Order Inserts

Inserts are made of the thermosetting resin, high grade thermoplastic or of aluminium alloy. They have metallic retention clips to retain the contacts. Each insert has one polarization slot which has its corresponding pin in each shell cavity.

Environmental inserts have:

- A) a silicon rubber ring that ensures sealing between the insert and the shell.
- B) a rear grommet which ensures sealing around each wire crimped on a contact.
- C) an interfacial seal which ensures sealing around each protruding contact once the connector is mated.

Non environmental inserts do not include options "b" or "c."

All standardized inserts are for rear release, rear removable contacts, please refer to page 5-13 for front release, front removable version.

HOW TO ORDER INSERTS

	MPX	E	2	P	11T2	A	S
--	-----	---	---	---	------	---	---

Series _____
MPX series

Class ⁽¹⁾ _____

E - Insert with interfacial seal, rear grommet and o-ring
N - Insert with o-ring, without interfacial seal and rear grommet
T - Insert with o-ring and interfacial seal without rear grommet

Insert size _____

1 - Insert for A, C and E shell cavities
2 - Insert for B, D and F shell cavities

Insert type _____

P - Insert for plug shell
R - insert for receptacle shell

Contact arrangement ⁽²⁾ _____
Refer to pages 5-14 to 5-21

Triax contact grounding ⁽³⁾ _____

Letter omitted - triax and quadrax contacts are grounded
A - triax contacts not grounded

Contact delivery _____

Letter omitted - insert is delivered without contacts
S - insert is delivered with crimp signal and power contacts (no coax, triax, twinax or quadrax contacts)

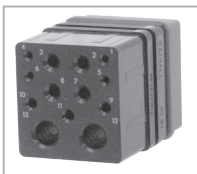

NOTES:

- (1) E, N and T classes apply to inserts for rear release rear removable contacts
- (2) Inserts 100 and 150 for front release front removable contacts are available, see page 5-13 for part numbers
- (3) When A is omitted triax and quadrax contacts cavities are grounded to the shell

How to Order MPX Assembly Kit

HOW TO ORDER ASSEMBLED CONNECTORS

	MPX	E	2	R	202	A	S	00	01
--	-----	---	---	---	-----	---	---	----	----

Series _____
MPX series

Class ⁽¹⁾ _____
E - Insert with interfacial seal, rear grommet and o-ring
N - Insert with o-ring, without interfacial seal and rear grommet
T - Insert with o-ring and interfacial seal without rear grommet

Shell Size _____
2 - 2 Cavities
3 - 4 Cavities
4 - 6 Cavities

Shell type _____
R - Receptacle shell
A - Plug shell

Insert combination code _____
Refer to pages 5-11 to 5-13

Triax contact grounding _____
 Letter omitted - triax contacts are grounded
A - triax contacts not grounded

contact type ⁽²⁾ _____
X - Without contacts
S - Crimp contacts
 Rear release PC-Tail : see page 5-23 to 5-32 and consult us for the PCB foot print

Modificaiton code _____
Refer to page 5-21

Polarization code _____
Blank - Polarization device delivered unassembled
00 - Polarizing keys or posts are not delivered
Other - please refer to page 5-22



NOTES:

- (1) E, N and T classes apply to inserts for rear release rear removable contacts
- (2) Coaxial, triaxial, twinax and quadrax contacts must be ordered separately

Insert Combination code

DOD-STD-1842 CODES (USA)

CODE	SHELL SIZE	Insert combination on shell					
		CAVITY A	CAVITY B	CAVITY C	CAVITY D	CAVITY E	CAVITY F
001	2	47T2	100	/	/	/	/
002	2	47T2	20T4	/	/	/	/
003	2	47T2	34	/	/	/	/
004	3	150	34	150	20T4	/	/
005	3	150	100	47T2	100	/	/
006	3	60	100	60	100	/	/
007	3	150	100	150	100	/	/
008	3	60	34	60	34	/	/
009	4	150	34	150	20T4	150	20T4
010	4	24	34	150	100	150	20T4
011	4	150	34	150	20T4	150	T6
012	4	24	34	150	BLANK	150	20T4

STTEA CODES (EUROPE)

CODE	SHELL SIZE	Insert combination on shell					
		CAVITY A	CAVITY B	CAVITY C	CAVITY D	CAVITY E	CAVITY F
201	2	150	34	/	/	/	/
202	3	150	20T4	BLANK	100	/	/
203	2	126	100	/	/	/	/
204	2	150	11C2	/	/	/	/
205	3	150	T6	150	T6	/	/
206	3	150	34	150	20T4	/	/
207	2	150	20T4	/	/	/	/
208	3	150	20T4	150	BLANK	/	/
209	2	47T2	11C2	/	/	/	/
210	3	150	11C2	24	100	/	/
211	2	150	11T2	/	/	/	/
212	2	60	11T2	/	/	/	/
213	3	24	34	24	20T4	/	/
214	3	24	34	BLANK	20T4	/	/
215	3	150	100	C12T6	11C2	/	/
216	2	150	100	/	/	/	/
217	2	24	11C2	/	/	/	/
218	3	24	11C2	24	T6	/	/
219	4	24	11C2	47T2	34	24	20T4
220	4	150	100	150	100	150	100
221	4	24	34	150	20T4	150	T6
222	3	150	11T2	24	100	/	/
223	3	150	11C2	150	11C2	/	/
224	2	150	62T2	/	/	/	/
225	2	60	20T4	/	/	/	/
226	3	150	34	150	100	/	/

Insert Combination code

STTEA CODES (EUROPE)

CODE	SHELL SIZE	Insert combination on shell					
		CAVITY A	CAVITY B	CAVITY C	CAVITY D	CAVITY E	CAVITY F
227	3	150	20T4	24	BLANK	/	/
228	3	150	100	150	20T4	/	/
229	3	150	20T4	24	11C2	/	/
230	2	47T2	BLANK	/	/	/	/
231	2	24	BLANK	/	/	/	/
232	2	24	34	/	/	/	/
233	3	150	34	150	34	/	/
234	3	24	11C2	150	100	/	/
235	3	150	BLANK	150	20T4	/	/
236	4	24	34	24	BLANK	150	20T4
237	2	24	100	/	/	/	/
238	3	BLANK	11C2	BLANK	20T4	/	/
239	3	24	34	24	34	/	/
240	3	47T2	34	24	34	/	/
241	4	24	34	24	34	24	34
242	3	BLANK	11C2	BLANK	34	/	/
243	3	60	34	24	34	/	/
244	4	60	34	60	34	24	34
245	3	150	11C2	24	11C2	/	/
246	4	24	34	60	100	150	20T4
247	4	24	34	24	100	150	20T4
248	4	60	T6	60	T6	24	T6
249	4	60	T6	BLANK	T6	150	T6
250	3	24	BLANK	150	20T4	/	/
251	3	126	34	126	20T4	/	/
252	3	150	34	BLANK	11C2	/	/
253	3	24	100	150	20T4	/	/
254	3	150	62T2	150	62T2	/	/
255	3	150	11C2	BLANK	34	/	/
256	2	60	11C2	/	/	/	/
257	3	150	100	C12T6	34	/	/
258	3	150	11C2	150	34	/	/
259	4	150	20T4	24	T6	150	11T2
260	3	150	T6	150	34	/	/
261	3	150	11C2	126	34	/	/
262	3	150	100	150	62T2	/	/
263	2	60	34	/	/	/	/
264	3	150	T6	150	100	/	/
265	3	C12T6	11C2	150	100	/	/
266	2	47T2	11T2	/	/	/	/
267	4	150	34	150	100	150	34
269	2	126	11T2	/	/	/	/
270	3	150	11T2	150	20T4	/	/
271	3	150	11T2	150	11T2	/	/
272	4	150	34	150	100	150	20T4

Insert Combination code

STTEA CODES (EUROPE)

CODE	SHELL SIZE	Insert combination on shell					
		CAVITY A	CAVITY B	CAVITY C	CAVITY D	CAVITY E	CAVITY F
273	4	126	100	150	100	126	100
274	3	C12T6	11C2	BLANK	100	/	/
275	3	150	T6	150	BLANK	/	/
276	2	150	T6	/	/	/	/
277	3	C12T6	34	60	34	/	/
278	3	150	20T4	150	20T4	/	/
279	3	60	20T4	60	20T4	/	/
280	4	150	100	150	100	150	62T2
281	3	150	11C2	150	100	/	/
282	3	150	11T2	150	100	/	/
283	3	BLANK	20T4	150	20T4	/	/
284	3	150	20T4	150	100	/	/
285	3	150	20T4	150	11C2	/	/
286	3	126	T6	150	20T4	/	/
287	3	150	11C2	150	20T4	/	/

Inserts Layouts Front Release Front Removable

CONTACT ARRANGEMENTS FOR FRONT RELEASE FRONT REMOVABLE CONTACTS

These inserts are available for receptacle shell only and are designed to be fitted with front release front removable size 22 pc tail contacts and thus do not have rear grommets. Socket insert mating side shown. These inserts are not normalized.

618500061

Number of contacts	Contact size	Location
150	22	1 to 150





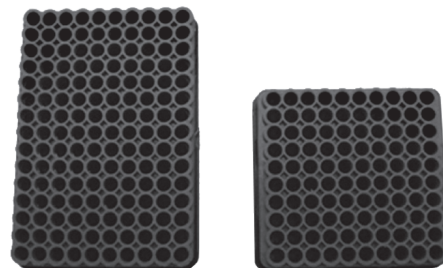









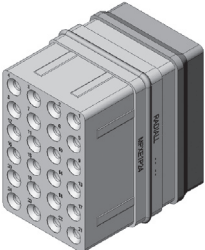

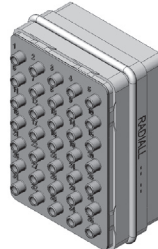
618500081

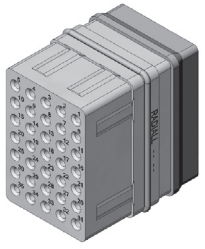
Number of contacts	Contact size	Location
100	22	1 to 100



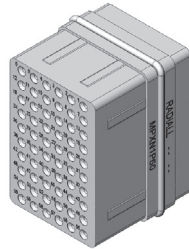
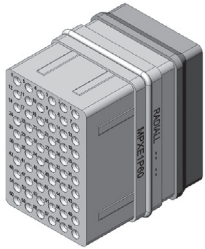

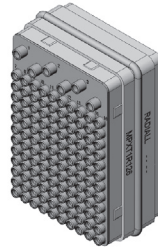

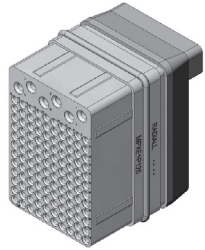
Insert Layout for Cavities A, C, or E

The symbol A represents that the insert is available in a non-grounded version (see page 5-9 for triax contact grounding)

Insert name	EQUIPMENT SIDE RECEPTACLE SHELL			AVIONIC SIDE PLUG SHELL	
	Version N	Version E	Version T	Version N	Version E
24 ^(A)					
	24x #12 RR/RR	24x #12 RR/RR	24x #12 RR/RR	24x #12 RR/RR	24x #12 RR/RR
35 ^(A)					
	35x #16 RR/RR	35x #16 RR/RR	35x #16 RR/RR	35x #16 RR/RR	35x #16 RR/RR
60 ^(A)					
	60x #20 RR/RR	60x #20 RR/RR	60x #20 RR/RR	60x #20 RR/RR	60x #20 RR/RR
126 ^(A)					
	120x #22 RR/RR 6x #16 RR/RR	120x #22 RR/RR 6x #16 RR/RR	120x #22 RR/RR 6x #16 RR/RR	120x #22 RR/RR 6x #16 RR/RR	120x #22 RR/RR 6x #16 RR/RR



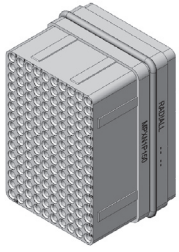
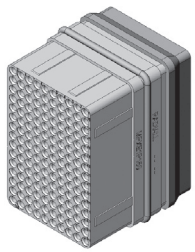
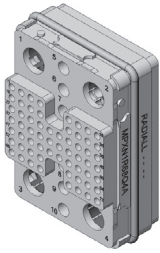

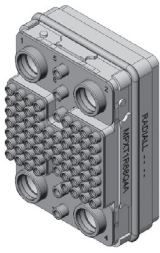
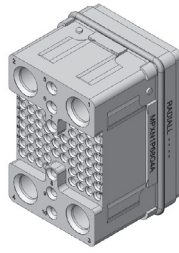
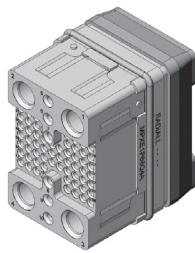

Insert Layout for Cavities A, C, or E

The symbol A represents that the insert is available in a non-grounded version (see page 5-9 for triax contact grounding)

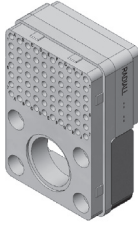
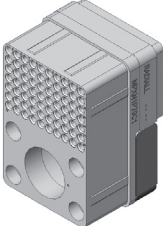
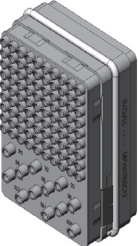
Insert name	EQUIPMENT SIDE RECEPTACLE SHELL			AVIONIC SIDE PLUG SHELL	
	Version N	Version E	Version T	Version N	Version E
150 ^(A)					
	150x #22 RR/RR	150x #22 RR/RR	150x #22 RR/RR	150x #22 RR/RR	150x #22 RR/RR
68Q4 ^(A)					
	62x #22 RR/RR 6x #16 RR/RR 4x #8 RR/RR	62x #22 RR/RR 6x #16 RR/RR 4x #8 RR/RR	62x #22 RR/RR 6x #16 RR/RR 4x #8 RR/RR	62x #22 RR/RR 6x #16 RR/RR 4x #8 RR/RR	62x #22 RR/RR 6x #16 RR/RR 4x #8 RR/RR

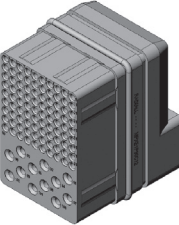



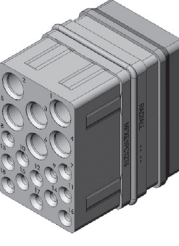





Insert Layout for Cavities A, C, or E

The symbol A represents that the insert is available in a non-grounded version (see page 5-9 for triax contact grounding)

Insert name	EQUIPMENT SIDE RECEPTACLE SHELL			AVIONIC SIDE PLUG SHELL	
	Version N	Version E	Version T	Version N	Version E
70C1 ^(A)		Not available	Not available		Not available
	70x #22 RR/RR 1x #1 FR/RR			70x #22 RR/RR 1x #1 FR/RR	
90C12 ^(A)		Not available			
	90x #22 RR/RR12x #16 RR/RR		90x #22 RR/RR12x #16 RR/RR	90x #22 RR/RR12x #16 RR/RR	90x #22 RR/RR12x #16 RR/RR
C12T6 (metallic insert)					
	12x #12 RR/RR 6x #8 RR/RR	12x #12 RR/RR 6x #8 RR/RR	12x #12 RR/RR 6x #8 RR/RR	12x #12 RR/RR 6x #8 RR/RR	12x #12 RR/RR 6x #8 RR/RR

Insert Layout for Cavities A, C, or E











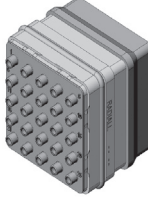
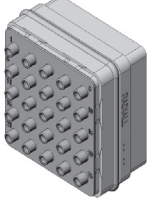
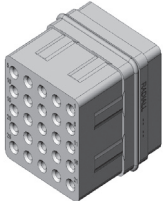
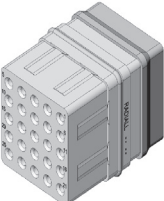

The symbol A represents that the insert is available in a non-grounded version (see page 5-9 for triax contact grounding)

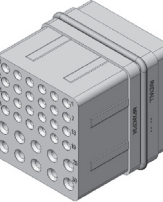
Insert name	EQUIPMENT SIDE RECEPTACLE SHELL			AVIONIC SIDE PLUG SHELL	
	Version N	Version E	Version T	Version N	Version E
Q11 (metallic insert)					
	11x #8 RR/RR	11x #8 RR/RR	11x #8 RR/RR	11x #8 RR/RR	11x #8 RR/RR
T10 (metallic insert)					
	10x #8 RR/RR	10x #8 RR/RR	10x #8 RR/RR	10x #8 RR/RR	10x #8 RR/RR

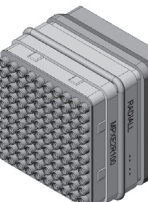
MPX SERIES

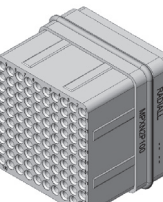
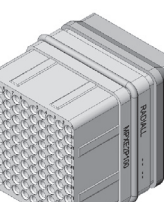
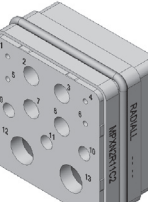



Insert Layout for Cavities B, D, or F

The symbol A represents that the insert is available in a non-grounded version (see page 5-9 for triax contact grounding)

Insert name	EQUIPMENT SIDE RECEPTACLE SHELL			AVIONIC SIDE PLUG SHELL	
	Version N	Version E	Version T	Version N	Version E
25 ^[A]					
	25x #16 RR/RR	25x #16 RR/RR	25x #16 RR/RR	25x #16 RR/RR	25x #16 RR/RR
34 ^[A]					
	24x #20 RR/RR 10x #16 RR/RR	24x #20 RR/RR 10x #16 RR/RR	24x #20 RR/RR 10x #16 RR/RR	24x #20 RR/RR 10x #16 RR/RR	24x #20 RR/RR 10x #16 RR/RR
100 ^[A]					
	100x #22 RR/RR	100x #22 RR/RR	100x #22 RR/RR	100x #22 RR/RR	100x #22 RR/RR
11C2 ^[A]					
	4x #20 RR/RR 3x #16 RR/RR 4x #12 RR/RR 2x #5 RR/RR	4x #20 RR/RR 3x #16 RR/RR 4x #12 RR/RR 2x #5 RR/RR	4x #20 RR/RR 3x #16 RR/RR 4x #12 RR/RR 2x #5 RR/RR	4x #20 RR/RR 3x #16 RR/RR 4x #12 RR/RR 2x #5 RR/RR	4x #20 RR/RR 3x #16 RR/RR 4x #12 RR/RR 2x #5 RR/RR



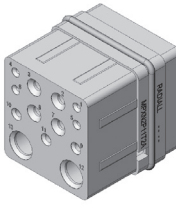

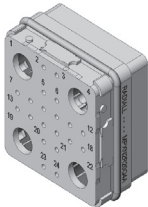
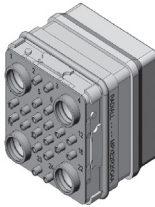
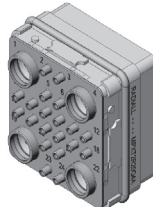
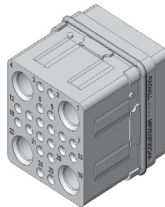
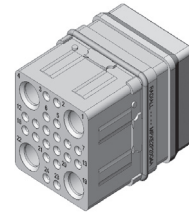
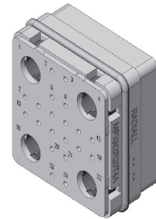
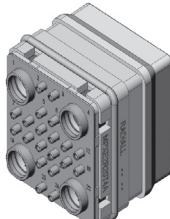
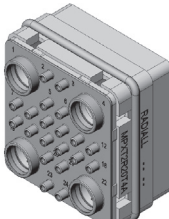
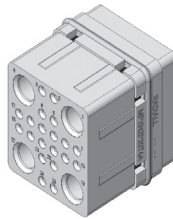
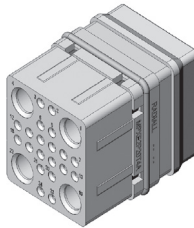





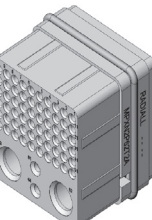
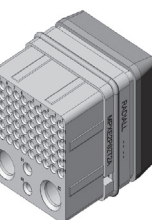

Insert Layout for Cavities B, D, or F

The symbol A represents that the insert is available in a non-grounded version (see page 5-9 for triax contact grounding)

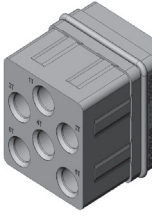
Insert name	EQUIPMENT SIDE RECEPTACLE SHELL			AVIONIC SIDE PLUG SHELL	
	Version N	Version E	Version T	Version N	Version E
11T2 ^(A)					
	4x #20 RR/RR 3x #16 RR/RR 2x #8 RR/RR 4x #12 RR/RR	4x #20 RR/RR 3x #16 RR/RR 2x #8 RR/RR 4x #12 RR/RR	4x #20 RR/RR 3x #16 RR/RR 2x #8 RR/RR 4x #12 RR/RR	4x #20 RR/RR 3x #16 RR/RR 2x #8 RR/RR 4x #12 RR/RR	4x #20 RR/RR 3x #16 RR/RR 2x #8 RR/RR 4x #12 RR/RR
20Q4 ^(A)					
	20x #20 RR/RR4x #8 Quadrax RR/RR	20x #20 RR/RR4x #8 Quadrax RR/RR	20x #20 RR/RR4x #8 Quadrax RR/RR	20x #20 RR/RR4x #8 Quadrax RR/RR	20x #20 RR/RR4x #8 Quadrax RR/RR
20T4 ^(A)					
	20x #20 RR/RR 4x #8 RR/RR	20x #20 RR/RR 4x #8 RR/RR	20x #20 RR/RR 4x #8 RR/RR	20x #20 RR/RR 4x #8 RR/RR	20x #20 RR/RR 4x #8 RR/RR

Insert Layout for Cavities B, D, or F

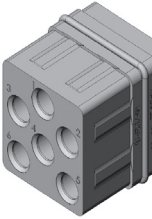
The symbol A represents that the insert is available in a non-grounded version (see page 5-9 for triax contact grounding)

Insert name	EQUIPMENT SIDE RECEPTACLE SHELL			AVIONIC SIDE PLUG SHELL	
	Version N	Version E	Version T	Version N	Version E
62T2 ^{IA}					
	60x #22 RR/RR 2x #16 RR/RR 2x #8 RR/RR	60x #22 RR/RR 2x #16 RR/RR 2x #8 RR/RR	60x #22 RR/RR 2x #16 RR/RR 2x #8 RR/RR	60x #22 RR/RR 2x #16 RR/RR 2x #8 RR/RR	60x #22 RR/RR 2x #16 RR/RR 2x #8 RR/RR
Q6 (metallic insert)					
	6x #8 RR/RR	6x #8 RR/RR	6x #8 RR/RR	6x #8 RR/RR	6x #8 RR/RR
T6 (metallic insert)					
	6x #8 RR/RR	6x #8 RR/RR	6x #8 RR/RR	6x #8 RR/RR	6x #8 RR/RR

Modification Code

Code	Receptacle Shell	Plug Shell
00	Sizes 2,3 & 4 : All holes Ø .150 inch (3.80 mm)	Sizes 2,3 & 4 : All holes Ø .150 inch (3.80 mm)
10	Sizes 2,3 & 4: All holes fitted with M3 x 0.02 inch (0.50 mm) clinch-nuts	Sizes 2,3 & 4: All holes fitted with M3 x 0.02 inch (0.50 mm) clinch-nuts

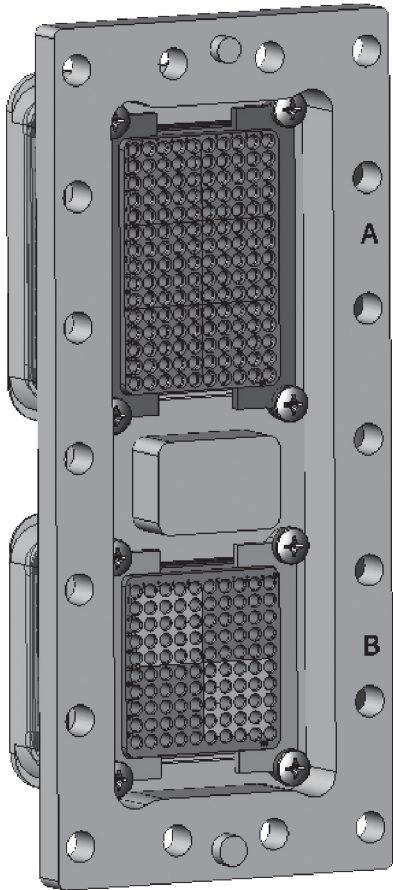

CODE 00

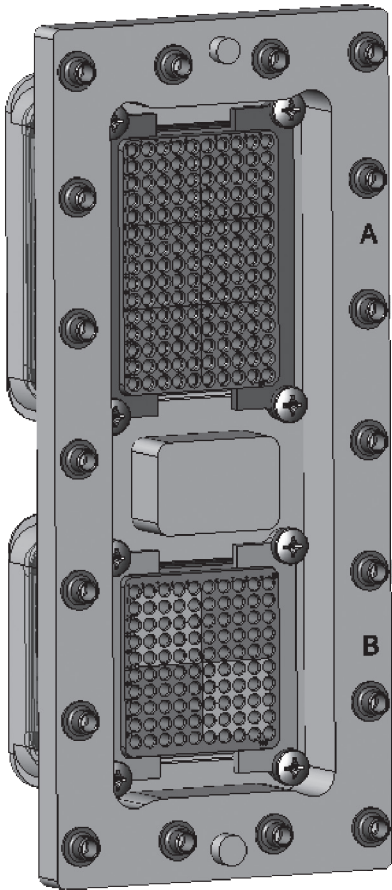

CODE 10

Polarization Code

POSITION OF POLARIZATION KEYS AND POSTS

Connectors are shown front side and with cavity A upwards.

POSITION CODINGS

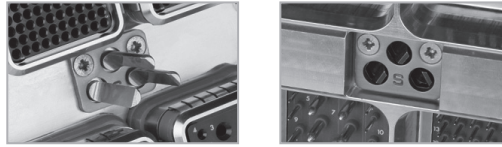

Dark area represents the polarizing post

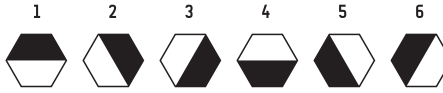

Clear portion represents the key hole

Code number	Receptacle shell			Plug shell		
	Left key	Center key	Right key	Left post	Center post	Right post
00	/	/	/	/	/	/
01	4	4	4	1	1	1
02	4	4	3	2	1	1
03	4	4	2	3	1	1
04	4	4	1	4	1	1
05	4	4	6	5	1	1
06	4	4	5	6	1	1
07	5	4	4	1	1	6
08	5	4	3	2	1	6
09	5	4	2	3	1	6
10	5	4	1	4	1	6
11	5	4	6	5	1	6
12	5	4	5	6	1	6
13	6	4	4	1	1	5
14	6	4	3	2	1	5
15	6	4	2	3	1	5
16	6	4	1	4	1	5
17	6	4	6	5	1	5
18	6	4	5	6	1	5
19	1	4	4	1	1	4
20	1	4	2	2	1	4
21	1	4	2	3	1	4
22	1	4	1	4	1	4
23	1	4	6	5	1	4
24	1	4	5	6	1	4
25	2	4	4	1	1	3
26	2	4	3	2	1	3
27	2	4	2	3	1	3
28	2	4	1	4	1	3
29	2	4	6	5	1	3
30	2	4	5	6	1	3
31	3	4	4	1	1	2
32	3	4	3	2	1	2
33	3	4	2	3	1	2
34	3	4	1	4	1	2
35	3	4	6	5	1	2
36	3	4	5	6	1	2
37	4	3	4	1	2	1
38	4	3	3	2	2	1
39	4	3	2	3	2	1
40	4	3	1	4	2	1
41	4	3	6	5	2	1
42	4	3	5	6	2	1
43	5	3	4	1	2	6
44	5	3	3	2	2	6
45	5	3	2	3	2	6
46	5	3	1	4	2	6
47	5	3	6	5	2	6
48	5	3	5	6	2	6
49	6	3	4	1	2	5

Code number	Receptacle shell			Plug shell		
	Left key	Center key	Right key	Left post	Center post	Right post
50	6	3	3	2	2	5
51	6	3	2	3	2	5
52	6	3	1	4	2	5
53	6	3	6	5	2	5
54	6	3	5	6	2	5
55	1	3	4	1	2	4
56	1	3	3	2	2	4
57	1	3	2	3	2	4
58	1	3	1	4	2	4
59	1	3	6	5	2	4
60	1	3	5	6	2	4
61	2	3	4	1	2	3
62	2	3	3	2	2	3
63	2	3	2	3	2	3
64	2	3	1	4	2	3
65	2	3	6	5	2	3
66	2	3	5	6	2	3
67	3	3	4	1	2	2
68	3	3	3	2	2	2
69	3	3	2	3	2	2
70	3	3	1	4	2	2
71	3	3	6	5	2	2
72	3	3	5	6	2	2
73	4	2	4	1	3	1
74	4	2	3	2	3	1
75	4	2	2	3	3	1
76	4	2	1	4	3	1
77	4	2	6	5	3	1
78	4	2	5	6	3	1
79	5	2	4	1	3	6
80	5	2	3	2	3	6
81	5	2	2	3	3	6
82	5	2	1	4	3	6
83	5	2	6	5	3	6
84	5	2	5	6	3	6
85	6	2	4	1	3	5
86	6	2	3	2	3	5
87	6	2	2	3	3	5
88	6	2	1	4	3	5
89	6	2	6	5	3	5
90	6	2	5	6	3	5
91	1	2	4	1	3	4
92	1	2	3	2	3	4
93	1	2	2	3	3	4
94	1	2	1	4	3	4
95	1	2	6	5	3	4
96	1	2	5	6	3	4
97	2	2	4	1	3	3
98	2	2	3	2	3	3
99	2	2	2	3	3	3

Contacts

The MPX series contacts are offered in crimp and pc tail termination. Pin contacts are installed in the receptacle shell and socket contacts in the plug shell except size 22 contacts for which pin contacts are installed in the plug shell and socket contacts in the receptacle shell.

Size 22 contacts in pc tail termination are offered in both rear release rear removable and front release front removable style. All the other sizes of contacts are offered in the rear release rear removable style only. The contacts are installed and removed using normalized MIL81969 tooling. They also have low insertion and extraction force.

Following is the contacts range available in types and sizes.

- Size 22 signal contacts
- Sizes 20, 16 and 12 power contacts
- Sizes 12, 16, 5 and 8 coaxial contacts
- Size 8 twinax contacts for shielded twisted pairs
- Size 8 quadrax contacts



SIGNAL AND POWER CRIMP CONTACTS Release Rear Removable

Contact size (2)	Wire				Pin p/n	Socket p/n	Crimping tool Radiall p/n (MIL p/n)	Positioner p/n	Selector p/n	Ins/ext tool p/n
	AWG	Cross section (mm ²)	Wire Outside dia. Inch (mm)	Stripping length inch (mm)						
	26	0.14	.030 [0.76]	.137 (3.5)	618200	618300	282970 (M22520/2-23)	3	282885 (M81969/1-01)	
	24	0.21	to .052 (1.32)					3		
	22	0.38						4		
20 reduced crimp barrel	26	0.14	.030 [0.76]	.157 (4.0)	/	618311	282281 (M22520/2-01)	3	282549029 (M81969/14-10)	
	24	0.21	to .052 [1.32]					3		
	22	0.38						4		
20	24	0.21	.035 [0.89]	618210	618310	282971 (M22520/2-08)	282971 (M22520/2-08)	5		
	22	0.38	to .060 [1.52]					6		
	20	0.60						7		
16	20	0.60	.048 [1.21]	.236 [6.0]	618230	618330	282972 (M22520/1-02)	4	282515 (M81969/14-03)	
	18	0.93	to .080 [2.03]					5		
	16	1.34						6		
12	14	3.18	.091 [2.31]	.236 [6.0]	618240	618340	282291 (M22520/1-01)	7	282549004 (M81969/14-04)	
	12	1.91	to .114 [2.90]					8		
12 reduced crimp barrel	20	0.60	.048 [1.21]	/	618341	282579 (M22520/1-11)	282579 (M22520/1-11)	4		
	18	0.93	to 080 [2.03]					5		
	16	1.34						6		
12 enlarged crimp barrel	10	5.0	.234 [5.70]	.354 [9.0]	/	618342	282296 (M22520/1-01)	1		
8 non environmental	10	5.0	.234 [5.70]	.354 [9.0]	618270	618370	282296 (DANIELS M300 BT) (1)	282586	6	282549001 (M81969/28-03)
8 environmental					618270001	618370001				

Notes

- (1) DANIELS WA27-309-EP air pressure tool with crimp setting 5 can also be used
Crimp setting 5 is not adjustable and must be set by the factory
(2) Contacts size 22,20,16 and 12 are M39029/94 & M39029/93 or EN3155/026 & EN3155/027 design

Contacts

SIGNAL AND POWER PC TAIL CONTACTS Release Rear Removable

For details on A & B dimensions refer to page 5-35

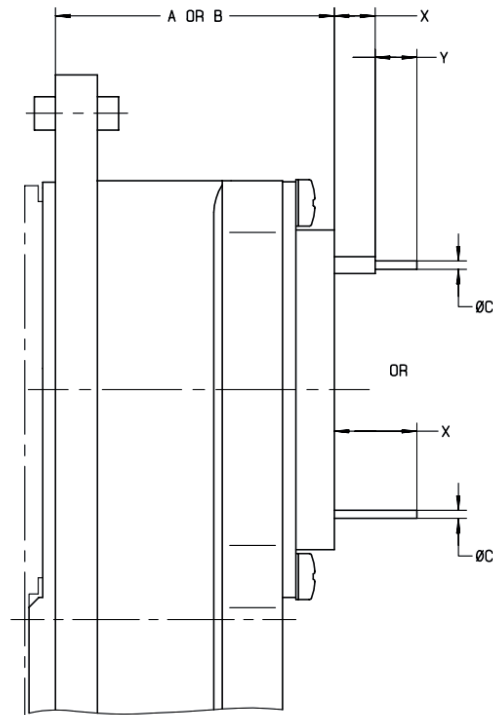

GOLD PC TAIL CONTACTS

Contact size	Contact arrangement	Pin	Socket	Ext. tool	X		Y	C
					inch (mm)	inch (mm)	inch (mm)	
22	618500061 & 618500081	/	618304001	282500	.163/.191 (4.15/4.85)	.173/.181 (4.40/4.60)	.024/.027 (0.60/0.70)	
		/	618304002		.085/.112 (2.15/2.85)	.232/.240 (5.90/6.10)		
		/	618360		.150/.180 (3.80/4.60)	N/A		
		/	618361		.252/.283 (6.40/7.20)	N/A		
		/	618362		.374/.405 (9.50/10.3)	N/A		

PRE-TINNED PC TAIL CONTACTS

Contact size	Contact arrangement	Pin	Socket	Ext. tool	X		Y	C
					inch (mm)	inch (mm)	inch (mm)	
22	618500061 & 618500081	/	618304003	282500	.163/.191 (4.15/4.85)	.173/.201 (4.40/5.10)	.031 (0.80) max	
		/	618304004		.085/.112 (2.15/2.85)	.232/.260 (5.90/6.60)		
		/	618360001		.150/.201 (3.80/5.10)	N/A		
		/	618361001		.252/.303 (6.40/7.70)	N/A		
		/	618362001		.374/.425 (9.50/10.80)	N/A		

Contacts

**SIGNAL AND POWER PC TAIL CONTACTS Rear Release Rear Removable
GOLD PC TAIL CONTACTS**

Contact size	Contact arrangement	Pin	Socket	Ext. tool	X		C
					inch (mm)	inch (mm)	
22	150 126 70C12 100 62T2	/	618302	282885 (M81969/1-01)	.059/.087 (1.50/2.20)	.145/.154 (3.70/3.90)	.024/.027 (0.60/0.70)
		/	618303001		.209/.248 (5.30/6.30)	N/A	
		/	618303002		.391/.431 (9.95/10.95)	N/A	
		/	618303003	or 282522 (M81969/14-01)	.138/.177 (3.50/4.50)	N/A	
		/	618303004		.150/.169 (3.80/4.30)	.145/.154 (3.70/3.90)	
		/	618303005		.303/.343 (7.70/8.70)	N/A	
		/	618303005				

PRE-TINNED PC TAIL CONTACTS

Contact size	Contact arrangement	Pin	Socket	Ext. tool	X		C
					inch (mm)	inch (mm)	
22	150 126 70C12 100 62T2	/	618302001	2282885 (M81969/1-01)	.059/.107 (1.50/2.70)	.145/.174 (3.70/4.40)	.031 (0.80) max
		/	618303007		.209/.268 (5.30/6.80)	N/A	
		/	618303008		.391/.451 (9.95/14.45)	N/A	
		/	618303009	or 282522 (M81969/14-01)	.138/.197 (3.50/5.00)	N/A	
		/	618303010		.150/.189 (3.80/4.80)	.145/.174 (3.70/4.40)	
		/	618303011		.303/.363 (7.70/9.20)	N/A	
		/	618303011				

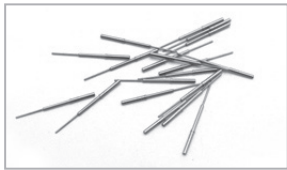

GOLD PC TAIL CONTACTS

Contact size	Contact arrangement	Pin	Socket	Ext. tool	X		C
					inch (mm)	inch (mm)	
20	11T2	618213001	/	282886 (M81969/1-02)	.281/.321 (7.15/8.15)	N/A	.037/.040 (0.95/1.01)
	11C2	618213002	/		.137/.177 (3.50/4.50)	N/A	
	34, 60	618231005	/	or 282549029 (M81969/14-02)	.517/.557 (13.15/14.15)	N/A	
	47T2		/		.391/.431 (9.95/10.95)	N/A	
	20T4	/	618316001				

PRE-TINNED PC TAIL CONTACTS

Contact size	Contact arrangement	Pin	Socket	Ext. tool	X		C
					inch (mm)	inch (mm)	
20	11T2	618213006	/	282886 (M81969/1-02)	.281/.341 (7.15/8.65)	N/A	.045 (1.15) max
	11C2	618213007	/		.137/.197 (3.50/5.00)	N/A	
	34, 60		/	or 282549029 (M81969/14-02)	.517/.577 (13.15/14.65)	N/A	
	47T2	618231008	/				
20T4							

Contacts

**SIGNAL AND POWER PC TAIL CONTACTS Rear Release Rear Removable
GOLD PC TAIL CONTACTS**

Contact size	Contact arrangement	Pin	Socket	Ext. tool	X inch (mm)	Y inch (mm)	C inch (mm)
16	62T2	618233001	/	282546 (M81969/1-03)	.281/.321 (7.15/8.15)	N/A	.057/.061 (1.45/1.55)
	11C2						
	11T2	618233002	/	or 282515 (M81969/14-03)	.370/.409 (9.40/10.40)	N/A	
25, 34 35, 126	618233003						/



PRE-TINNED PC TAIL CONTACTS

Contact size	Contact arrangement	Pin	Socket	Ext. tool	X inch (mm)	Y inch (mm)	C inch (mm)
16	62T2	618233001	/	282546 (M81969/1-03)	.281/.321 (7.15/8.15)	N/A	.057/.061 (1.45/1.55)
	11C2						
	11T2	618233002	/	or 282515 (M81969/14-03)	.370/.409 (9.40/10.40)	N/A	
25, 34 35, 126	618233003						/

GOLD PC TAIL CONTACTS

Contact size	Contact arrangement	Pin	Socket	Ext. tool	X inch (mm)	Y inch (mm)	C inch (mm)
12	11C2	618243001	/	282547 (M81969/28-02)	.281/.321 (7.15/8.15)	N/A	.076/.080 (1.95/2.05)
	11T2, 6T4	618243002	/				
	24, C12T6 70C12	618243003	/	282549004 (M81969/14-04)	.137/.177 (3.50/4.50)	N/A	
					.076/.120 (1.95/3.05)	N/A	



PRE-TINNED PC TAIL CONTACTS

Contact size	Contact arrangement	Pin	Socket	Ext. tool	X inch (mm)	Y inch (mm)	C inch (mm)
12	11C2	618243001	/	282547 (M81969/28-02)	.281/.321 (7.15/8.15)	N/A	.076/.080 (1.95/2.05)
	11T2, 6T4	618243002	/				
	24, C12T6 70C12	618243003	/	282549004 (M81969/14-04)	.137/.177 (3.50/4.50)	N/A	
					.076/.120 (1.95/3.05)	N/A	

Contacts

**COAXIAL CRIMP CONTACTS Rear Release Rear Removable
DESIGN AS PER EN3155-028 & 029**

Contact size	Contact arrangement	Cable	Pin	Socket	Center contact			Outer body		
					Crimping tool	Positioner tool	Sel	Crimping tool	Positioner tool	Sel
16	126	RG179 RG316 KX22DS	618150	618050	282281 (M22520/2-01)	282555	282292 (M22520/4-01)	282556	/	4
	62T2	ASNE0752WS ASNE0632WK ASNE0639XY								1
	11C2	F1703-134 AXON P813859 & P822817 ASNE0690WL	618151	618051						2
	11T2									
	34									
	25	KX21DS	/	618053						1
	35	RG178 KX21	618154	618054						
		ASNE0633WG								

Ins/ext tool: 282546 (M81696/1-03)

DESIGN AS PER EN3155-030 & 031 / M39029/73 & 74

Contact size [2]	Contact arrangement	Cable	Pin	Socket	Center contact			Outer body		
					Crimping tool	Positioner tool	Sel	Crimping tool	Positioner tool	Sel
12	11C2	RG179 RG316	618140	618040	282281 (M22520/2-01)	282580	282297 (M22520/31-01)	282581	/	4
	11T2	ASNE0639XY ASNE0690WL	618140003	618040003						3
	24	BUS 3910 AXON P503031	618141	618041						5
	6T4	ASNE0633WG RG178 KX21	618142	618042						4
	C12T6 70C12									

Ins/ext tool: 282547 (M81696/28-02)

DESIGN AS PER EN3155-032 & 033 M39029/99 & 100

Contact size	Contact arrangement	Cable	Pin	Socket	Center contact			Outer body		
					Crimping tool	Positioner tool	Sel	Crimping tool	Positioner tool	
5	11C2	RG58 KX15	618120 ⁽¹⁾	618020 ⁽¹⁾	282281 (M22520/2-01)	282550	282293 (M22520/5-01)	282246 (M22520/5-05 hex A)	282246 (M22520/5-05 hex B)	6
		RG141 ASNE0293XF RG142								8
		RG223 RG400	/	618021001						8
		ASNE0691WM ASNE0639XY	618124001	618024001						6
										8
		RG179 RG187	618123 ⁽¹⁾	618023 ⁽¹⁾						7

Ins/Ext tool: 282946 (M81969/28-01)

A RADIALL DESIGN

Non environmental size 8 pin contacts are delivered with an alignment boot (p/n: 618920) to reduce the play at the contact extremity.

Contact size	Contact arrangement	Cable	Pin	Socket	Center contact			Outer body		
					Crimping tool	Positioner tool	Sel	Crimping tool	Positioner tool	
8	62T220T4	RG58 KX15	/	618030 ⁽¹⁾	282281 (M22520/2-01)	282572	282293 (M22520/5-01)	282236 (M22520/5-45 hex A)		6
	11T2	RG316								7
	T6	RG141 KX22	8							
	47T2	RG316	/	618032 ⁽¹⁾						7
	C12T6	RG174	/	618033 ⁽¹⁾						8
	6T4	RG400								
		ASNE0691WM	618135	618035 ⁽¹⁾						solder

Ins/Ext tool: 282549001 (M81969/28-03)

Contacts

PC TAIL COAX CONTACTS Rear Release Rear Removable
SIZE 16 PC TAIL mating interface as per EN3155-028 & 029

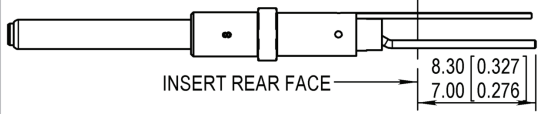
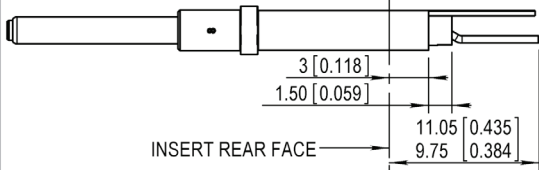
Contact type	Part number ⁽¹⁾	Contact drawing ⁽²⁾	Rear extension from all insert inch (mm)	Rear extension from 126 & 62T2 inserts only inch (mm)
Pin	618153		.275 / .327 (7.00 / 8.30)	.297 / .349 (7.55 / 8.85)
Pin	618153001		.383 / .435 (9.75 / 11.05)	.405 / .457 (10.30 / 11.60)

SIZE 16 PRE-TINNED PC TAIL

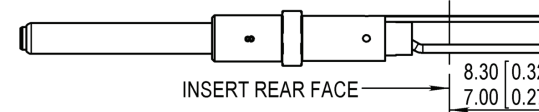
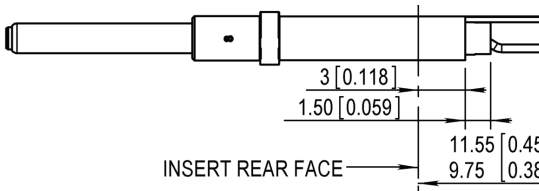
Contact type	Part number ⁽¹⁾	Contact drawing ⁽²⁾	Rear extension from all insert inch (mm)	Rear extension from 126 & 62T2 inserts only inch (mm)
Pin	618153002		.275 / .346 (7.00 / 8.80)	.297 / .368 (7.55 / 9.35)
Pin	618153003		.383 / .455 (9.75 / 11.55)	.405 / .476 (10.30 / 12.10)

NOTES:

(1) Contacts Ins/ext tool: 282546 (M81969/1-03)

(2) For PC drill pattern please contact Radiall

Contacts

PC TAIL COAX CONTACTS Rear Release Rear Removable
SIZE 12 PC TAIL mating interface design as per EN3155-030 & 031

Contact type	Part number ⁽¹⁾	Contact drawing ⁽²⁾	Rear extension from all insert inch (mm)	Rear extension from 70C12 insert only inch (mm)
Pin	618149002		.275 / .327 (7.00 / 8.30)	.307 / .358 (7.80 / 9.10).
Pin	618149003		.358 / .409 (9.10 / 10.40)	.390 / .441 (9.90 / 11.20).

SIZE 12 PRE-TINNED PC TAIL

Contact type	Part number ⁽¹⁾	Contact drawing ⁽²⁾	Rear extension from all insert inch (mm)	Rear extension from 70C12 inserts only inch (mm)
Pin	618149006		.275 / .347 (7.00 / 8.80)	.307 / .379 (7.80 / 9.60).
Pin	618149007		.358 / .429 (9.10 / 10.90)	.390 / .461 (9.90 / 11.70).

NOTES:

(1) Contacts Ins/ext tool: 282547 (M81969/28-02)

(2) For PC drill pattern please contact Radiall

Contacts

QUADRAX CONTACTS Rear Release Rear Removable
SIZE 8 QUADRAX CONTACTS design as per EN3155-072 & 073

Cable	Contact Type	Part number ⁽¹⁾ Non Environmental	Part number ⁽¹⁾ Environmental	INS/Ext Tool
ABS972	Pin	620175010	620175011	282549001 M81969/14.06
ABS1503KD24	Socket	620075010	620075011	
TENSOLITE	Pin	620175050	620175051	
NF24Q100 (100Ω)	Socket	620075050	620075051	
GORE RCN8487-1 (110Ω)	Pin	620175021	620175020	
	Socket	620075021	620075020	
THERMAX 956S-4T200	Pin	620179002	620179001	
GORE RCN8422 (110Ω)	Socket	620079002	620079001	



CONCENTRIC TWINAX CONTACTS Rear Release Rear Removable

SIZE 8 CRIMP CONTACTS
design as per EN3155-034 & 035 interchangeable with 042 & 043 interface in accordance with M39029/95

Contact size ^(1 & 3)	Contact arrangement	Cable	Pin contact ⁽²⁾	Socket contact ⁽²⁾
8	6T4	EN 3375-004	618160	618060
		EN 3375-005		
		EN 3375-003		
	62T2	M17/176-00002	618161	618061
		M17/176-00002		
	20T4	EN 3375-003	618162	618062
		EN 3375-004		
	11T2	EN 3375-005		
	T6	M17/176-00002		
	47T2	ECS 700		
C12T6	M17/176-00002	618166	618066	
		618180	/	

NOTES:

(1) Ins/Ext tool: 282549001 (M81969/28-03)

(2) Add 001 at the end of the contact part number to be provided with a sealing boot with the contact

(3) Non environmental size 8 pin contacts are delivered with an alignment boot (p/n: 618920) to reduce the play at the contact extremity

Contacts

CONCENTRIC TWINAX CONTACTS Rear Release Rear Removable
SIZE 8 PC TAIL CONTACTS mating interface design as per EN3155-034 & 035

Contact type	Part number ⁽⁴⁾	Contact drawing	Rear extension from all insert inch (mm)	Pc tail length inch (mm)	Rear extension from 62T2 insert only inch (mm)
Pin	618 163		.275 / .327 (7.00 / 8.30)	.275 / .327 (7.00 / 8.30)	.199 / .250 (5.05 / 6.35)
Pin	618 164		.480 / .520 (12.20 / 13.20)	.098 / .138 (2.50 / 3.50)	.403 / .443 (10.25 / 11.25)
Pin	618164001		.518 / .557 (13.15 / 14.15)	.234 / .238 (5.95 / 6.05)	.441 / .480 (11.20 / 12.20)

NOTES:

(1) Non environmental size 8 pin contacts are delivered with an alignment boot (p/n: 618920) to reduce the play at the contact extremity
 This alignment boot protrudes 2.5mm max from the rear face of the insert; these 2.5mm are taken into account in the dimensions listed above

Contacts

**CONCENTRIC TWINAX CONTACTS Rear Release Rear Removable
SIZE 8 PRE-TINNED PC TAIL CONTACTS**

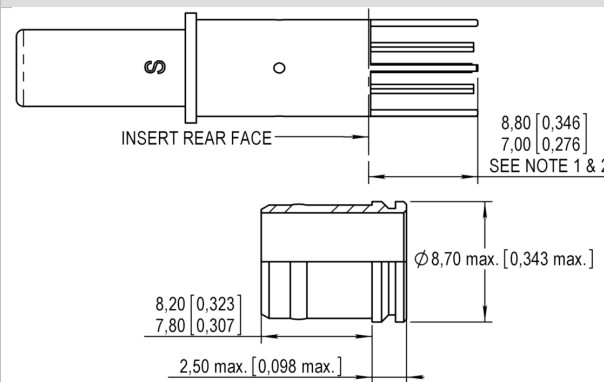
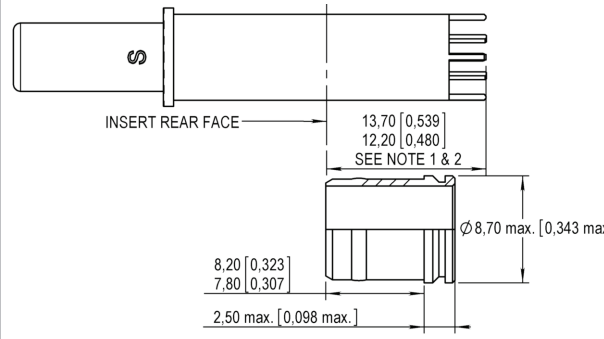
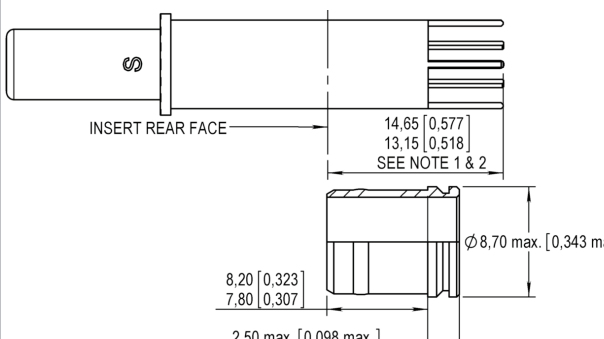
Contact type	Part number ⁽¹⁾	Contact drawing	Rear extension from all insert inch (mm)	Pc tail length inch (mm)	Rear extension from 62T2 insert only inch (mm)
Pin	618163005		.275 / .347 (7.00 / 8.80)	.297 / .347 (7.55 / 8.80)	.199 / .270 (5.05 / 6.85)
Pin	618164002		.480 / .540 (12.20 / 13.70)	.098 / .157 (2.50 / 4.00)	.403 / .463 (10.25 / 11.75)
Pin	618164003		.518 / .577 (13.15 / 14.65)	.234 / .258 (5.95 / 6.55)	.441 / .500 (11.20 / 12.70)

NOTES:

(1) Non environmental size 8 pin contacts are delivered with an alignment boot (p/n: 618920) to reduce the play at the contact extremity
This alignment boot protrudes 2.5mm max from the rear face of the insert; these 2.5mm are taken into account in the dimensions listed above

Accessories



SEALING PLUGS

Cavity size	Sealing plug P/N	Color
22	620920	black
20	620921	red
16	620922	blue
12	620923	yellow
5	618910 for pin 618912 for socket	white
8	618911 for pin 618913 for socket	red

FILLER PLUGS

Cavity size	Filler plug P/N	Color
22	616910	black
20	616911	red
16	616912	blue
12	616913	yellow
5	618910 + 618915	white
8	618911 + 618915	red

CAVITY REDUCERS

The cavity reducers are not removable from the insert once installed. They are made of copper alloy and are nickel plated to allow contact cavity grounding.

Cavity reducer type	Part number
From pin size 8 to size 12	Environmental: 618940001 Non environmental: 618940
From socket size 8 to size 12	Environmental: 618941001 Non environmental: 618941

BACKSHELLS

Backshells are made of aluminium alloy and are cadmium yellow chromate plated. To order one complete backshell you must order separately an EMI backshell plus a combination of backshell terminations (i.e. one complete backshell for cavity A = 4x 618802011 + 1x 618802010 + 1x 618801002)

Description	Part number
EMI backshell for cavities A, C & E	618801002
EMI backshell for cavities B, D & F	618800002
Backshell termination	618802010
Backshell blank termination	618802011

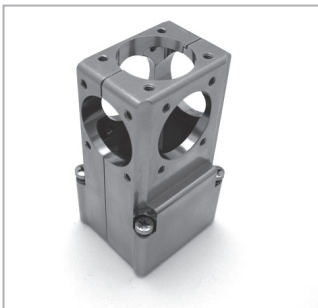

Accessories

DUST CAPS

Description	Part number
Conductive dust cap for receptacle shell	618953001
Conductive dust cap for plug shell	618953002
Non conductive dust cap for plug shell	618953



O-RING FOR INSERTS

Description	Part number
O-ring for inserts for A,C & E cavities	618953020
O-ring for inserts for B,D & F cavities	618953021

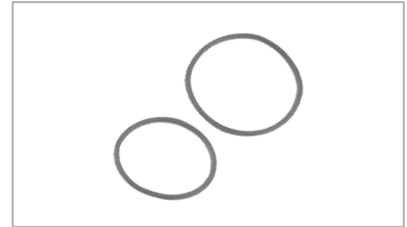

COUPLING SEALS

Description	Part number
Coupling seals for A,C & E shell cavities	618953010
Coupling seals for B,D & F shell cavities	618953011

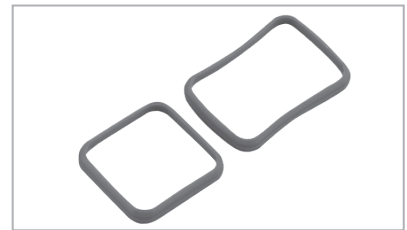

EMI SPRING

Description	Part number
Kit made of one EMI spring for A,C & E shell cavities and of one EMI spring for B, D & F	618810
EMI spring for A,C & E shell cavities	618810001
EMI spring for B,D & F shell cavities	618810002

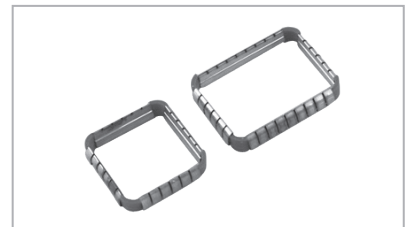

DUMMY INSERTS:

MPXE10: dummy insert for A, C and E shell cavities

MPXE20: dummy insert for B, D and F shell cavities

POLARIZATION KIT & SCREWS

A kit of 2 screws that are used to fix the polarization posts or keys retention plate is available under P/N: **618985**

A polarization kit for plug is P/N **618811002** and for receptacle it is P/N **618811001**. Torque is 0.7 N.m

Dimensions

The table below gives A and B dimension values (A and B = distance between the front flange of the connector and the rear face of the insert).

See drawings pages 5-36 to 5-41 for A and B description.

PLUG

Insert description	A and/or B dimension for environmental plug inch (mm)	A and/or B dimension for non environmental plug inch (mm)
60, T6, 11C2, 34 C12T6, 24, 35, 47T2, 13T4 6T4, 11T2, 25, 20T4, 20Q4, Q6, Q11	.386 / .449 (9.80 / 11.40)	No rear extension of inserts from shell
150, 100	.228 / .295 (5.80 / 7.50)	
62T2, 68Q4	A : Signal contacts .228 / .295 (5.80 / 7.50) B : Power contacts .468 / .512 (11.90 / 13.00)	
70C12, 126, 118Q2	A : Signal contacts .228 / .295 (5.80 / 7.50) B : Power contacts .386 / .449 (9.80 / 11.40)	

RECEPTACLE

Insert description	A and/or B dimension for environmental receptacle inch (mm)	A and/or B dimension for non environmental receptacle inch (mm)
60, T6, 11C2, 34 C12T6, 24, 35, 47T2, 13T4 6T4, 11T2, 25, 20T4, 20Q4, Q6, Q11	1.610 / 1.657 (40.90 / 42.10)	1.275 / 1.313 (32.40 / 33.35)
150, 100, 126	1.441 / 1.492 (36.60 / 37.90)	1.171 / 1.215 (29.75 / 30.85)
62T2, 68Q4, 118Q2	A : Signal contacts 1.441 / 1.492 (36.60 / 37.90) B : Power contacts 1.512 / 1.557 (38.40 / 39.55)	1.171 / 1.215 (29.75 / 30.85)
70C12	1.457 / 1.518 (37 / 38.55)	

MPX SERIES

Receptacle Size 2 Dimensions

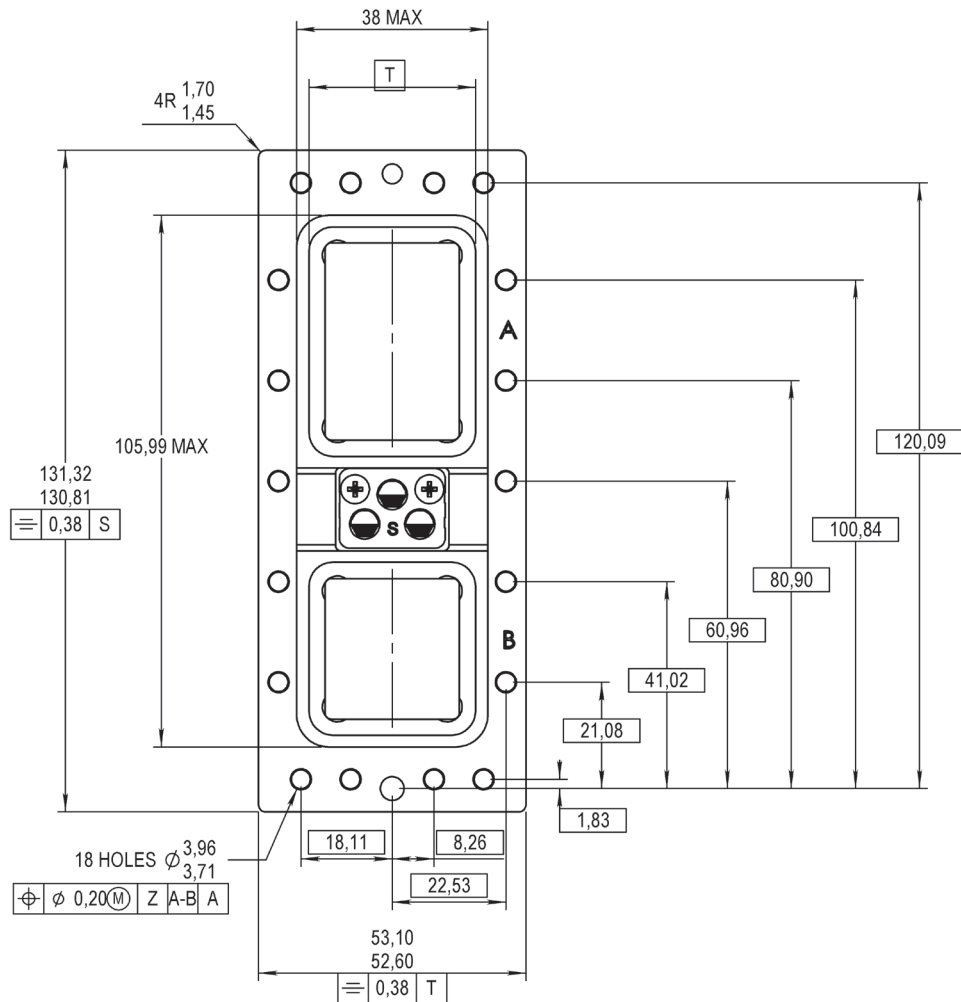
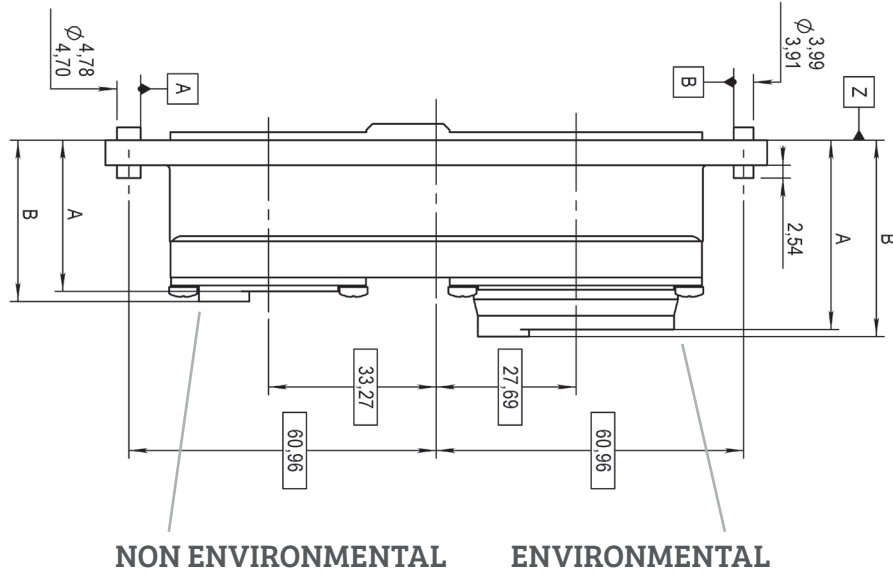

Plug Size 2 Dimensions

MPX SERIES

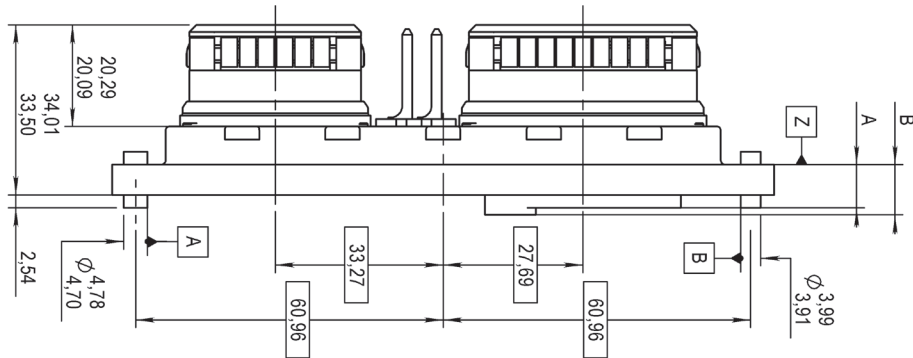

NON ENVIRONMENTAL

ENVIRONMENTAL

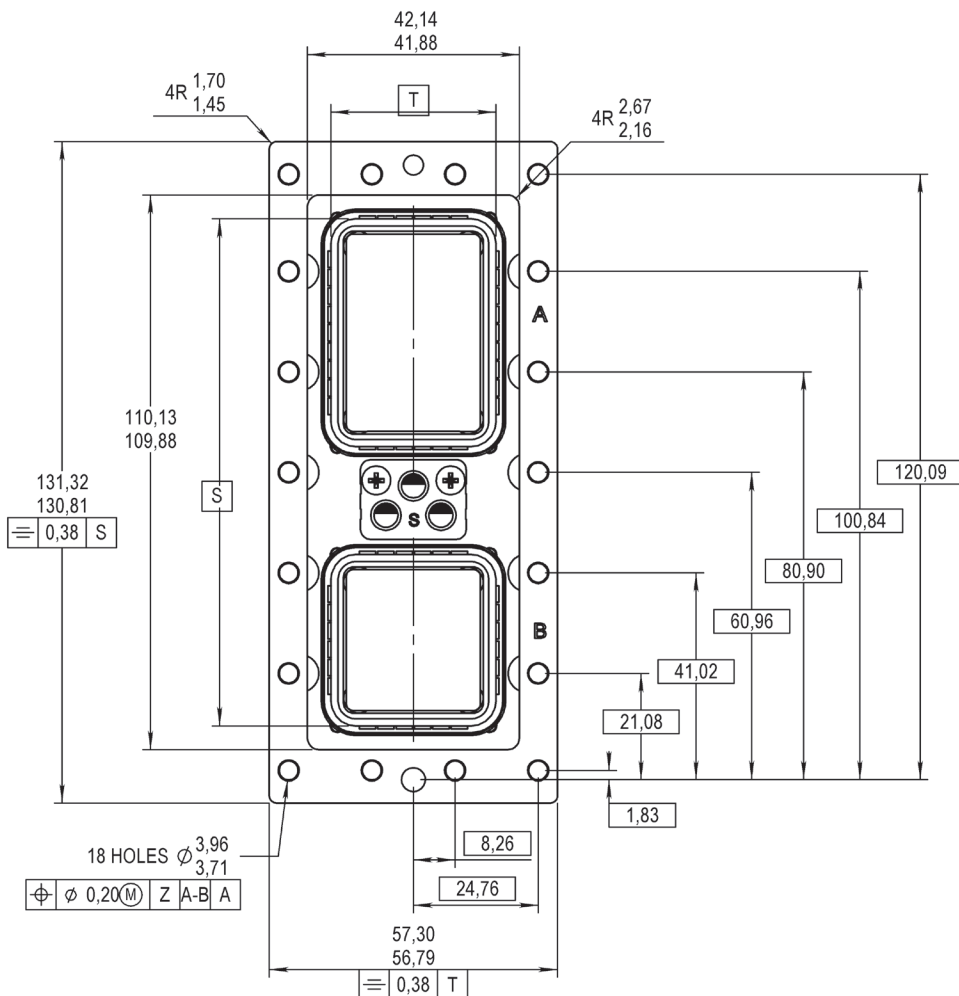

MPX SERIES

Receptacle Size 3 Dimensions

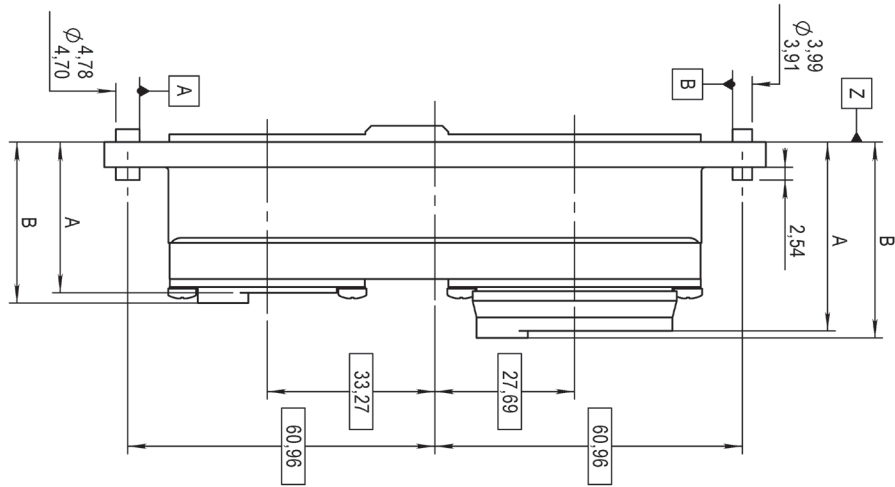

NON ENVIRONMENTAL ENVIRONMENTAL

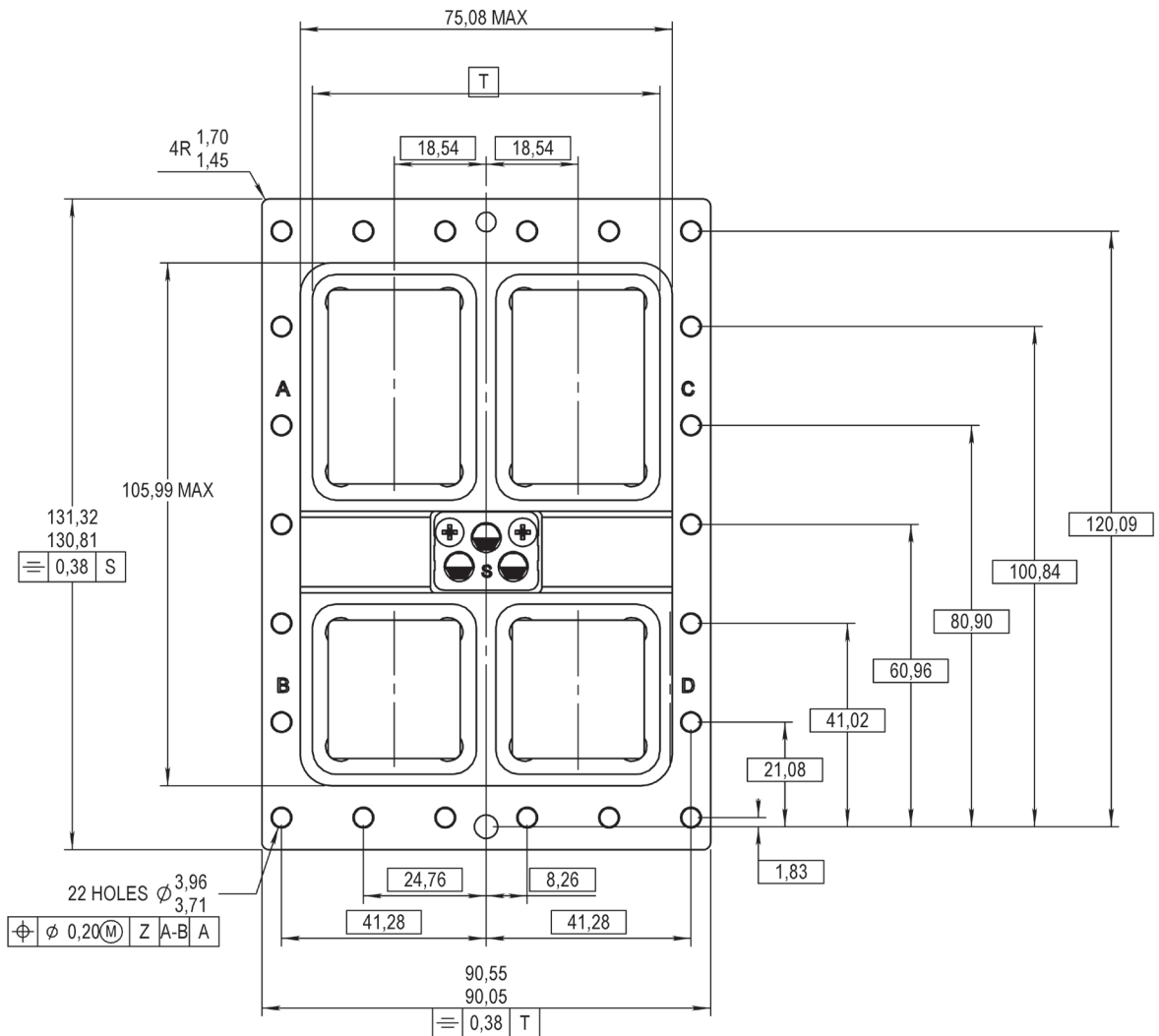

Plug Size 3 Dimensions

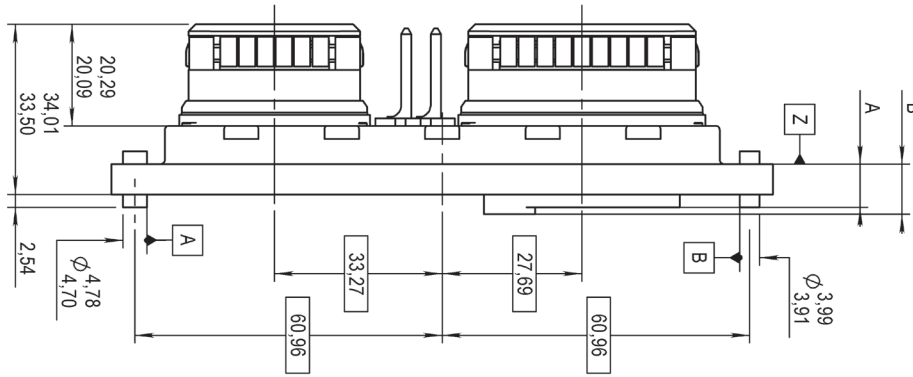

NON ENVIRONMENTAL ENVIRONMENTAL

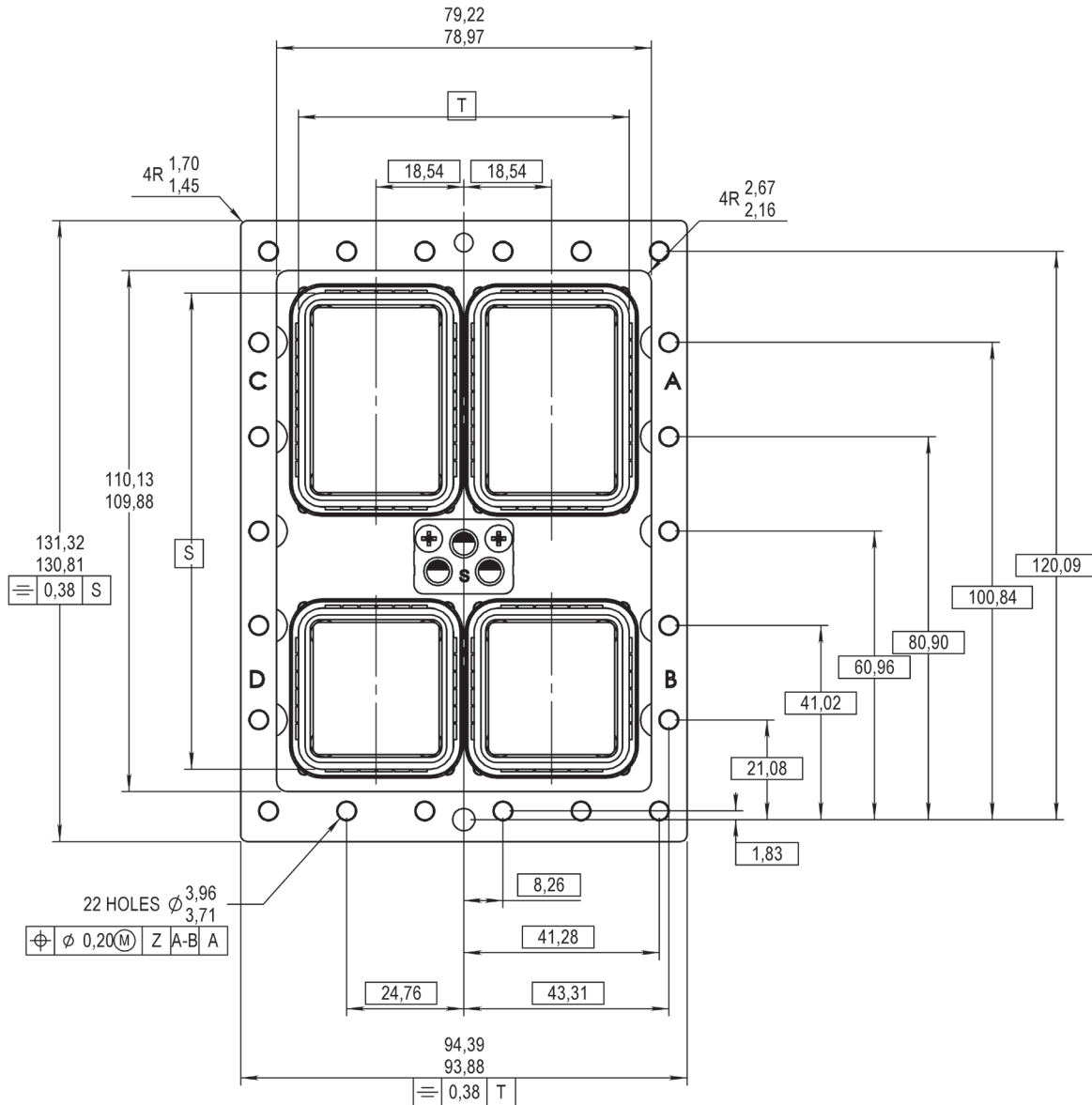

MPX SERIES

Receptacle Size 4 Dimensions

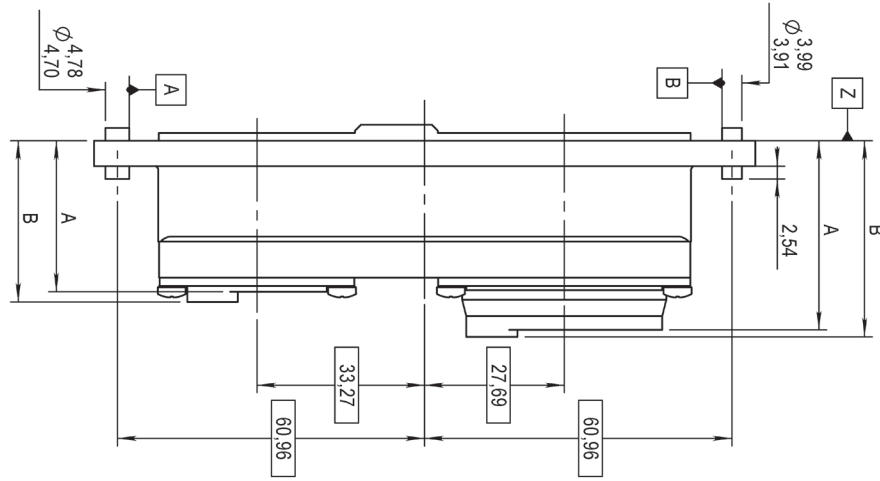

NON ENVIRONMENTAL ENVIRONMENTAL

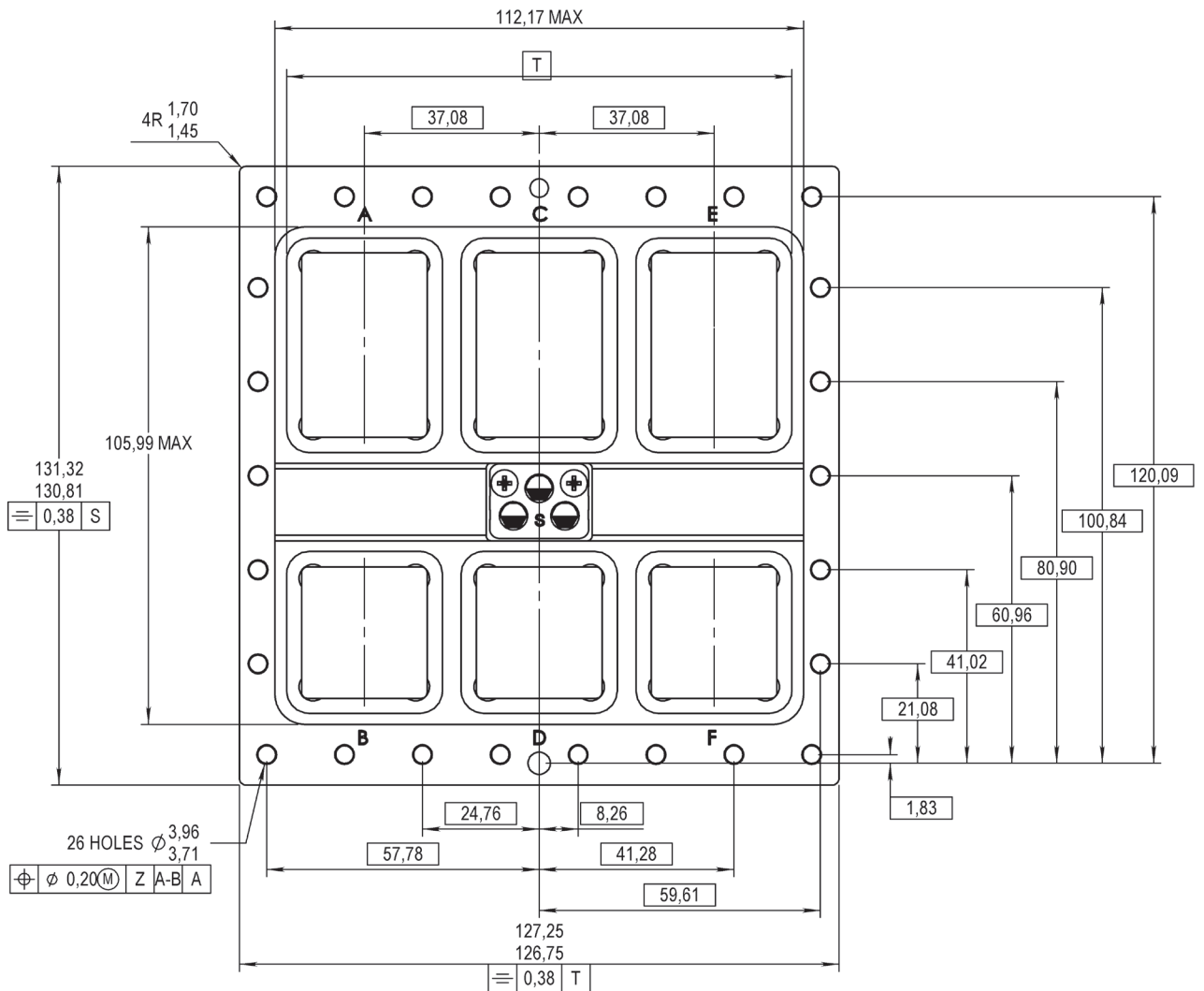

Plug Size 4 Dimensions

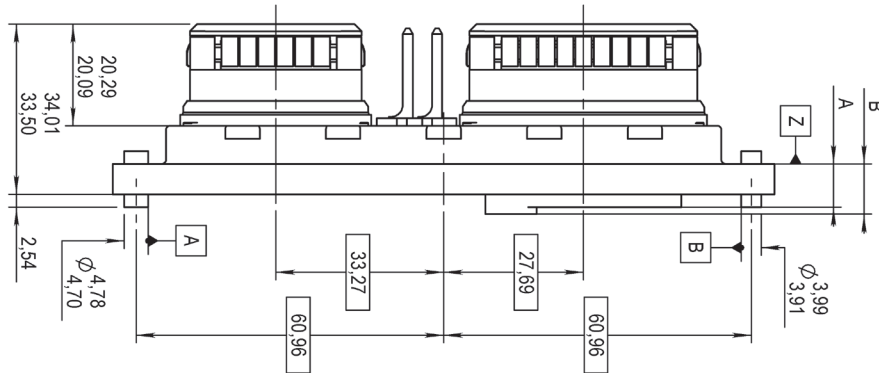

NON ENVIRONMENTAL ENVIRONMENTAL

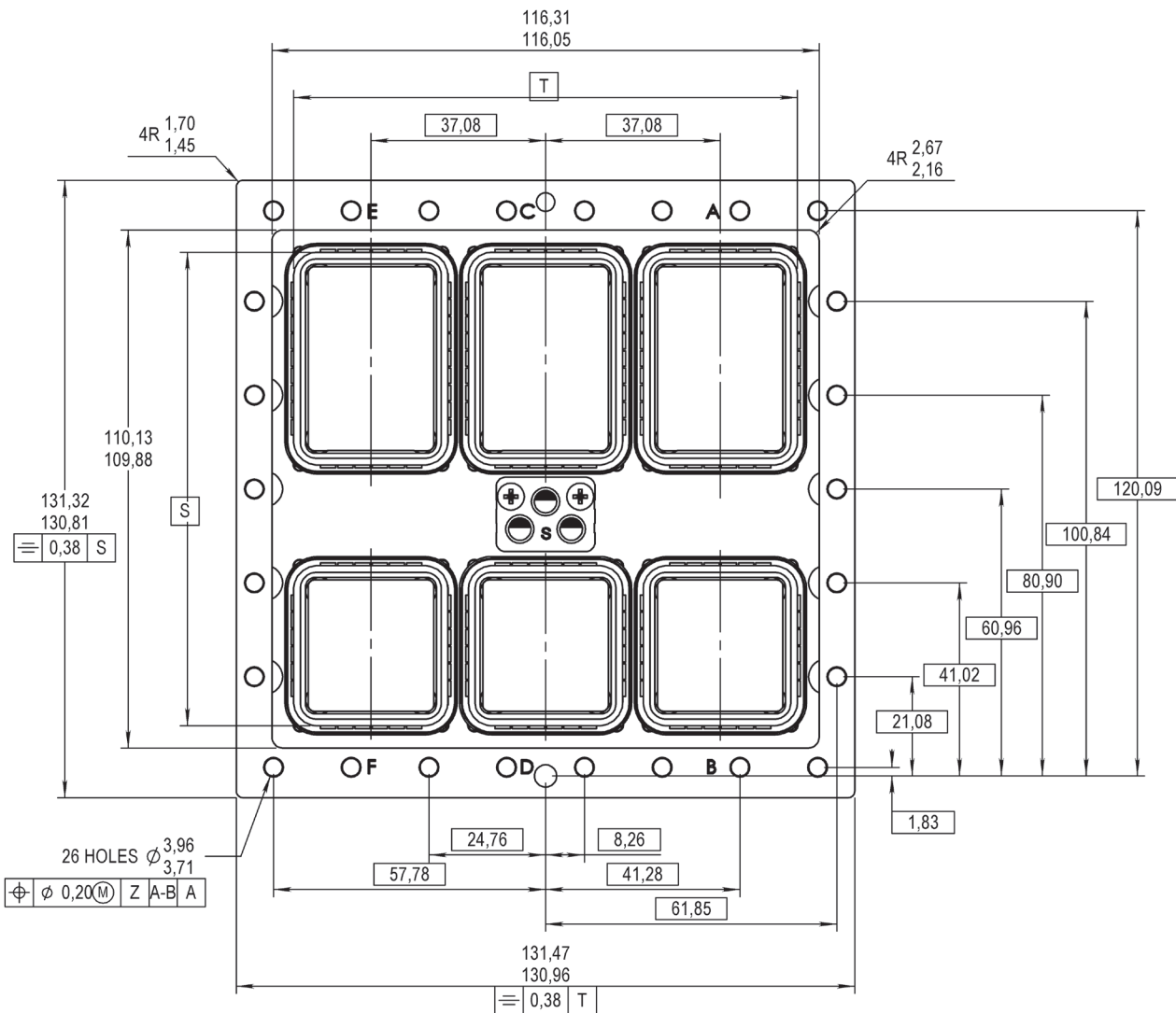

MPX SERIES

Equipment Receptacle Panel Cut-Out

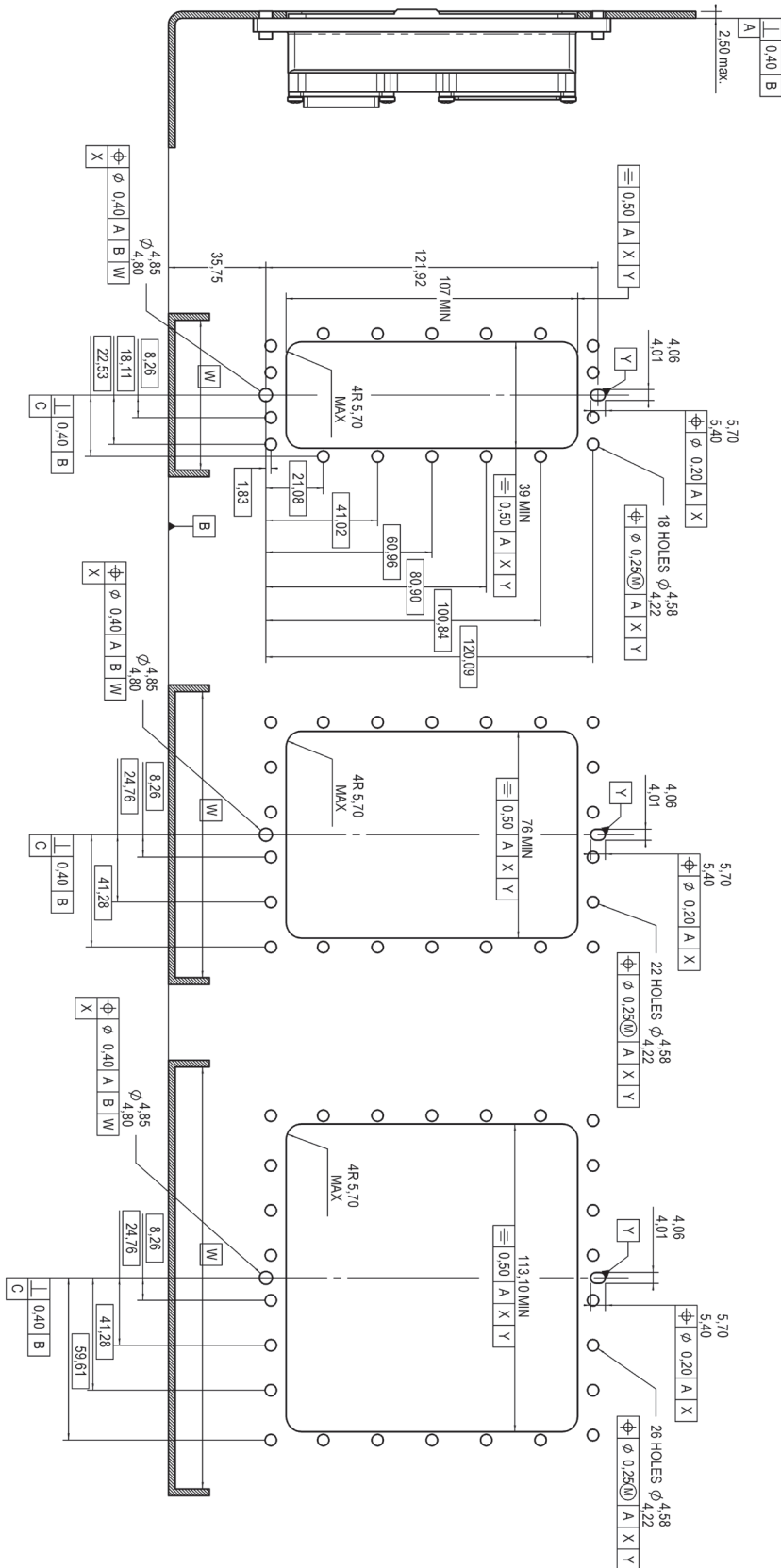

SIZE 2

SIZE 3

SIZE 4

MPX SERIES

Notes

area offices
local contacts



Our most
important
connection
is with you.™

It's not just a slogan. It's a statement of our earnest desire to put you at the forefront of all our business practices. As part of Radiall's mission to be available and accessible, we make it a priority to have local offices around the globe ready and able to assist you – wherever you are, whenever you need us.

Europe

	ADDRESS	PHONE	FAX	EMAIL
FINLAND	Radiall Finland PO Box 202 - 90101 Oulu	+358 407522412		infofi@radiall.com
FRANCE	Radiall SA 101 Rue Philibert Hoffmann 93116 Rosny Sous Bois	+33 1 49 35 35 35	+33 1 49 35 35 14	infofr@radiall.com
GERMANY	Radiall GmbH Carl Zeiss Str. 10 Postfach 200143 D63307 Rödermark	+49 60 74 91 07 0	+49 60 74 91 07 70	infode@radiall.com
ITALY	Radiall Elettronica S.R.L Via della Resistenza 113 - 20090 Buccinasco Milano	+39 02 48 85 121	+39 02 48 84 30 18	infoit@radiall.com
NETHERLANDS	Radiall Nederland BV Hogebrinkerweg 15b - 3871 KM Hoevelaken	+31 33 253 40 09	+31 33 253 45 12	infofl@radiall.com
SWEDEN	Radiall AB Sjöängsvägen 2 - SE - 192 72 Sollentuna	+46 8 444 34 10	+46 8 754 49 16	infose@radiall.com
UNITED KINGDOM	Radiall Ltd Ground Floor 6 The Grand Union Office Park Packet Boat Lane UXBRIDGE Middlesex UB8 2GH United Kingdom	+44 (0)1895 425000	+44 (0)1895 425010	infouk@radiall.com

Asia

	ADDRESS	PHONE	FAX	EMAIL
CHINA	Shanghai Radiall Electronics CO, Ltd N° 390 Yong He Rd SHANGHAI 200072 P.R.C	+86 21 66523788	+86 21 66521177	infosh@radiall.com
HONG KONG	Radiall Electronics (Asia) Ltd Flat D, 6/F, Ford Glory Plaza, 37-39 Wing Hong Street - Cheung Sha Wan - Kowloon - Hong Kong	+852 29593833	+852 29592636	infohk@radiall.com
INDIA	Radiall India Pvt. Ltd 25.D.II phase Peenya Industrial Area. Bangalore-560058	+91 80 23720989	+91 80 28397228	infoin@radiall.com
JAPAN	Nihon Radiall Shibuya-Ku Ebisu 1-5-2, Kougetsu Bldg 405 - Tokyo 150-0013	+81 3 34406241	+81 3 34406242	infojp@radiall.com

Americas

	ADDRESS	PHONE	FAX	EMAIL
USA & CANADA	Radiall USA, Inc. 8950 South 52nd Street Ste 401 Tempe, AZ 85284	+1 480-682-9400	+1 480-682-9403	infousa@radiall.com

Also Represented In...

AUSTRALIA AUSTRIA BELGIUM BRAZIL CZECH REPUBLIC DENMARK ESTONIA GREECE HUNGARY INDONESIA ISRAEL KOREA LATVIA LITHUANIA
MALAYSIA NORWAY PHILIPPINES POLAND PORTUGAL RUSSIA SINGAPORE SPAIN SWITZERLAND TAIWAN THAILAND VIETNAM SOUTH AFRICA