

MCV 1,5/10-GF-3,81 - PCB header



1830677

<https://www.phoenixcontact.com/in/products/1830677>

Please be informed that the data shown in this PDF document is generated from our Online Catalog. Please find the complete data in the user documentation. Our General Terms of Use for Downloads are valid.

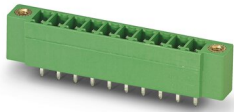

PCB headers, nominal cross section: 1.5 mm², color: green, nominal current: 8 A, rated voltage (III/2): 160 V, contact surface: Tin, type of contact: Pin, number of potentials: 10, number of rows: 1, number of positions: 10, number of connections: 10, product range: MCV 1,5/..-GF, pitch: 3.81 mm, mounting: Wave soldering, pin layout: Linear pinning, solder pin [P]: 3.4 mm, number of solder pins per potential: 1, plug-in system: COMBICON MC 1,5, Pin connector pattern alignment: Standard, locking: Screw locking, mounting: Threaded flange, type of packaging: packed in cardboard

Your advantages

- Well-known mounting principle allows worldwide use
- Screwable flange for superior mechanical stability
- Vertical connection enables multi-row arrangement on the PCB
- Maximum flexibility when it comes to device design – one header for connectors with different connection technologies

Commercial Data

Item number	1830677
Packing unit	100 pc
Minimum order quantity	100 pc
Sales Key	AAB
Product Key	AABSBF
Catalog Page	Page 227 (C-1-2013)
GTIN	4017918051327
Weight per Piece (including packing)	3.822 g
Weight per Piece (excluding packing)	3.822 g
Customs tariff number	85366930
Country of origin	DE

MCV 1,5/10-GF-3,81 - PCB header



1830677

<https://www.phoenixcontact.com/in/products/1830677>

Technical Data

Product properties

Type	Standard
Product line	COMBICON Connectors S
Product type	PCB headers
Product family	MCV 1,5/...-GF
Number of positions	10
Pitch	3.81 mm
Number of connections	10
Number of rows	1
Mounting flange	Threaded flange
Number of potentials	10
Pin layout	Linear pinning
Solder pins per potential	1

Electrical properties

Nominal current I_N	8 A
Nominal voltage U_N	160 V
Degree of pollution	3
Contact resistance	1.6 m Ω
Rated voltage (III/3)	160 V
Rated surge voltage (III/3)	2.5 kV
Rated voltage (III/2)	160 V
Rated surge voltage (III/2)	2.5 kV
Rated voltage (II/2)	250 V
Rated surge voltage (II/2)	2.5 kV

Mounting

Mounting type	Wave soldering
Pin layout	Linear pinning

Flange

Tightening torque	0.3 Nm
-------------------	--------

Material specifications

Material data - contact

Note	WEEE/RoHS-compliant, free of whiskers according to IEC 60068-2-82/JEDEC JESD 201
Contact material	Cu alloy
Surface characteristics	Tin-plated
Metal surface contact area (top layer)	Tin (3 - 5 μm Sn)
Metal surface contact area (middle layer)	Nickel (1 - 3 μm Ni)
Metal surface soldering area (top layer)	Tin (3 - 5 μm Sn)

MCV 1,5/10-GF-3,81 - PCB header

1830677

<https://www.phoenixcontact.com/in/products/1830677>

Metal surface soldering area (middle layer)	Nickel (1 - 3 µm Ni)
---------------------------------------------	----------------------

Material data - housing

Color (Housing)	green (6021)
Insulating material	PBT
Insulating material group	IIIa
CTI according to IEC 60112	225
Flammability rating according to UL 94	V0

Material data – actuating element

Color ()	()
----------	----

Dimensions

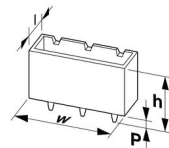
Dimensional drawing	
Pitch	3.81 mm
Width [w]	48.49 mm
Height [h]	12.6 mm
Length [l]	7.25 mm
Installed height	9.2 mm
Solder pin length [P]	3.4 mm

Mechanical tests

Test for conductor damage and slackening

Specification	IEC 60999-1:1999-11
Result	Test passed

Pull-out test

Specification	IEC 60999-1:1999-11
Conductor cross section/conductor type/tractive force setpoint/actual value	0.14 mm ² / solid / > 10 N
	0.14 mm ² / flexible / > 10 N
	1.5 mm ² / solid / > 40 N
	1.5 mm ² / flexible / > 40 N

Insertion and withdrawal forces

Result	Test passed
No. of cycles	25
Insertion strength per pos. approx.	7 N
Withdraw strength per pos. approx.	5 N

Torque test

Specification	IEC 60999-1:1999-11
---------------	---------------------

MCV 1,5/10-GF-3,81 - PCB header



1830677

<https://www.phoenixcontact.com/in/products/1830677>

Contact holder in insert

Specification	IEC 60512-15-1:2008-05
Contact holder in insert Requirements >20 N	Test passed

Resistance of inscriptions

Specification	IEC 60068-2-70:1995-12
Result	Test passed

Polarization and coding

Specification	IEC 60512-13-5:2006-02
Result	Test passed

Visual inspection

Specification	IEC 60512-1-1:2002-02
Result	Test passed

Dimension check

Specification	IEC 60512-1-2:2002-02
Result	Test passed

Electrical tests

Thermal test | Test group C

Specification	IEC 60512-5-1:2002-02
Tested number of positions	20

Insulation resistance

Specification	IEC 60512-3-1:2002-02
Insulation resistance, neighboring positions	> 5 MΩ

Air clearances and creepage distances |

Specification	IEC 60664-1:2007-04
Insulating material group	IIIa
Comparative tracking index (IEC 60112)	CTI 225
Rated insulation voltage (III/3)	160 V
Rated surge voltage (III/3)	2.5 kV
minimum clearance value - non-homogenous field (III/3)	1.5 mm
minimum creepage distance (III/3)	2.5 mm
Rated insulation voltage (III/2)	160 V
Rated surge voltage (III/2)	2.5 kV
minimum clearance value - non-homogenous field (III/2)	1.5 mm
minimum creepage distance (III/2)	1.6 mm
Rated insulation voltage (II/2)	250 V
Rated surge voltage (II/2)	2.5 kV
minimum clearance value - non-homogenous field (II/2)	1.5 mm
minimum creepage distance (II/2)	2.5 mm

MCV 1,5/10-GF-3,81 - PCB header



1830677

<https://www.phoenixcontact.com/in/products/1830677>

Environmental and real-life conditions

Vibration test

Specification	IEC 60068-2-6:2007-12
Frequency	10 - 150 - 10 Hz
Sweep speed	1 octave/min
Amplitude	0.35 mm (10 Hz ... 60.1 Hz)
Sweep speed	5g (60.1 Hz ... 150 Hz)
Test duration per axis	2.5 h

Durability test

Specification	IEC 60512-9-1:2010-03
Impulse withstand voltage at sea level	2.95 kV
Contact resistance R_1	1.6 m Ω
Contact resistance R_2	1.7 m Ω
Insertion/withdrawal cycles	25
Insulation resistance, neighboring positions	> 5 M Ω

Climatic test

Specification	ISO 6988:1985-02
Corrosive stress	0.2 dm ³ SO ₂ on 300 dm ³ /40 °C/1 cycle
Thermal stress	100 °C/168 h
Power-frequency withstand voltage	1.39 kV

Shocks

Specification	IEC 60068-2-27:2008-02
Pulse shape	Semi-sinusoidal
Acceleration	30g
Shock duration	18 ms
Test directions	X-, Y- and Z-axis (pos. and neg.)

Ambient conditions

Ambient temperature (operation)	-40 °C ... 100 °C (dependent on the derating curve)
Ambient temperature (storage/transport)	-40 °C ... 70 °C
Relative humidity (storage/transport)	30 % ... 70 %
Ambient temperature (assembly)	-5 °C ... 100 °C

Packaging specifications

Type of packaging	packed in cardboard
-------------------	---------------------

Drawings

Diagram

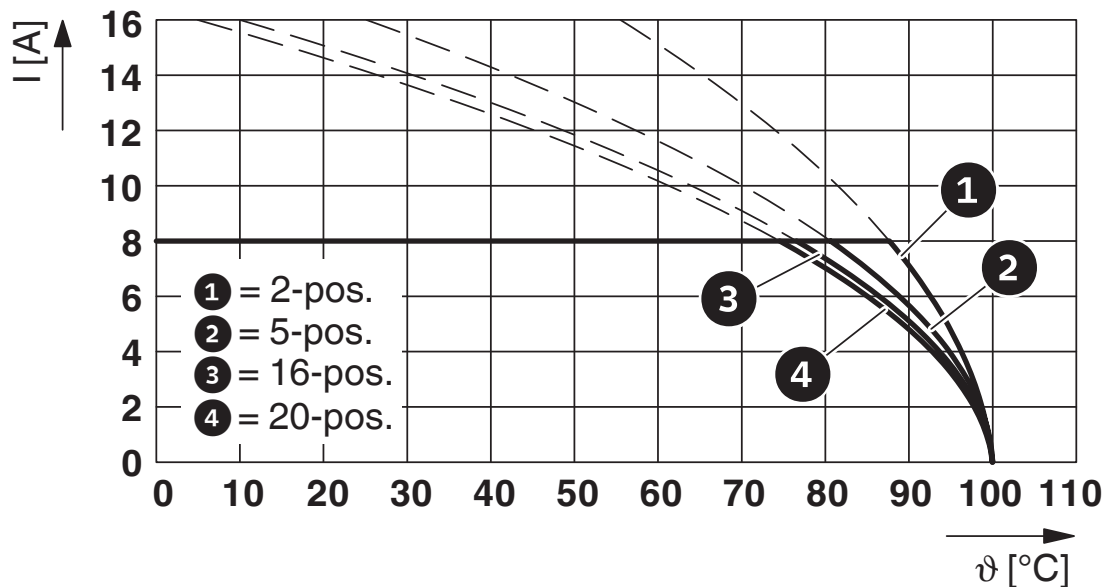

Type: FK-MCP 1,5/...-STF-3,81 with MCV 1,5/...-GF-3,81

Dimensional drawing

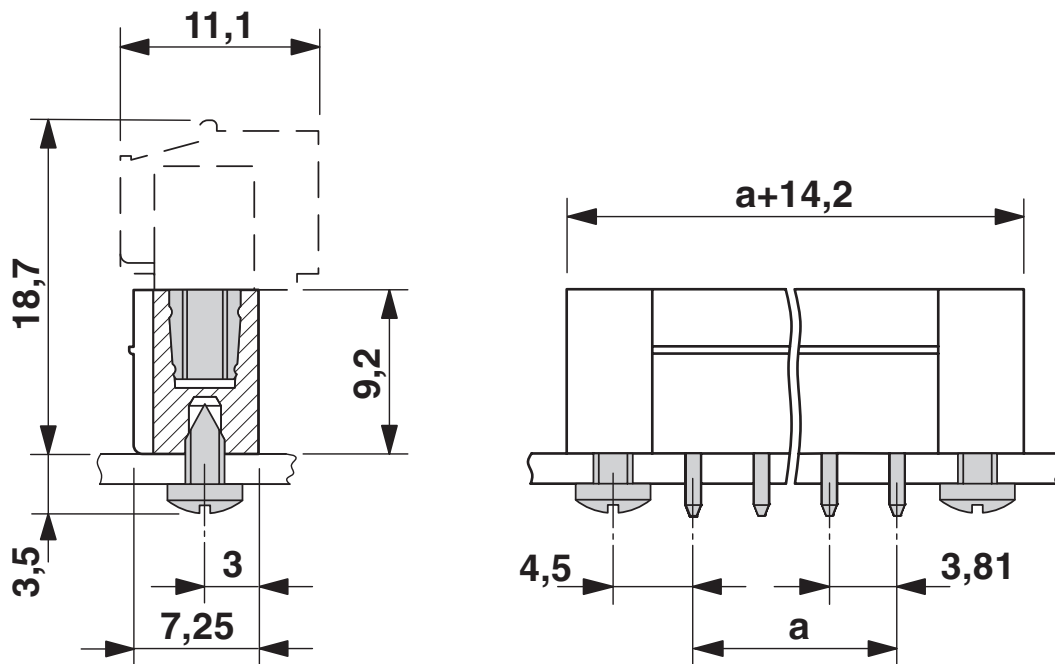

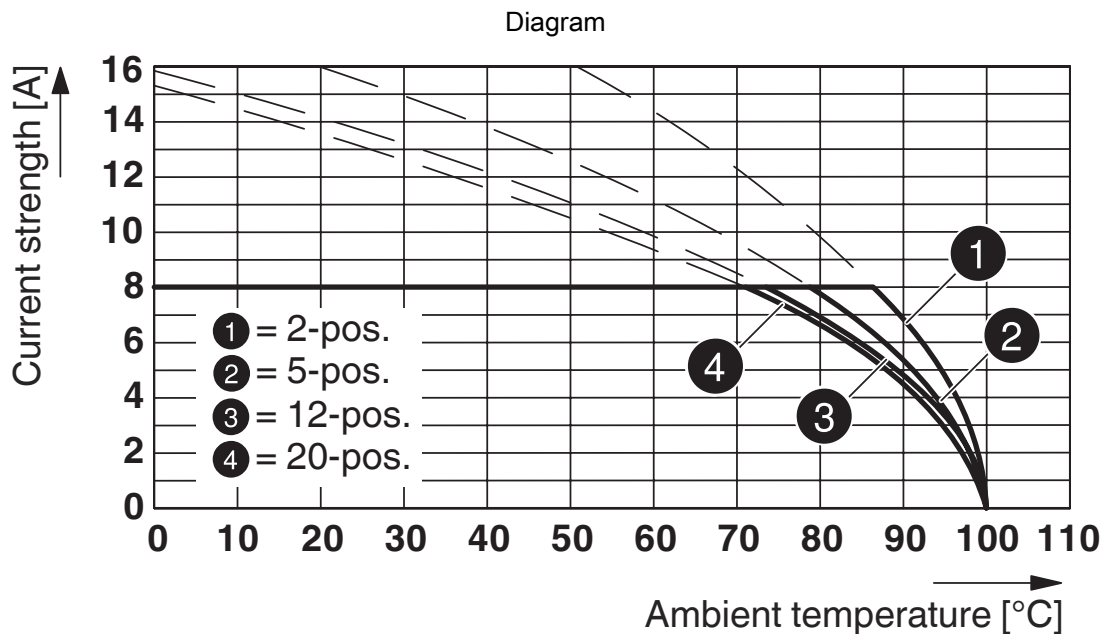

Type: FRONT-MC 1,5/...-STF-3,81 with MCV 1,5/...-GF-3,81

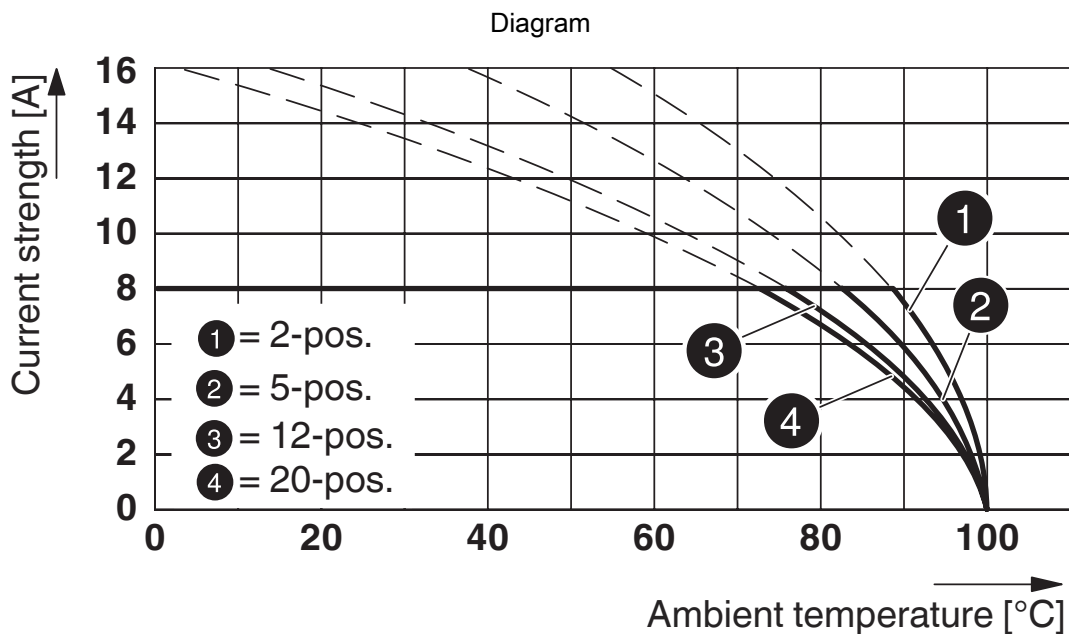

Type: MC 1,5/...-STF-3,81 with MCV 1,5/...-GF-3,81

MCV 1,5/10-GF-3,81 - PCB header

1830677

<https://www.phoenixcontact.com/in/products/1830677>

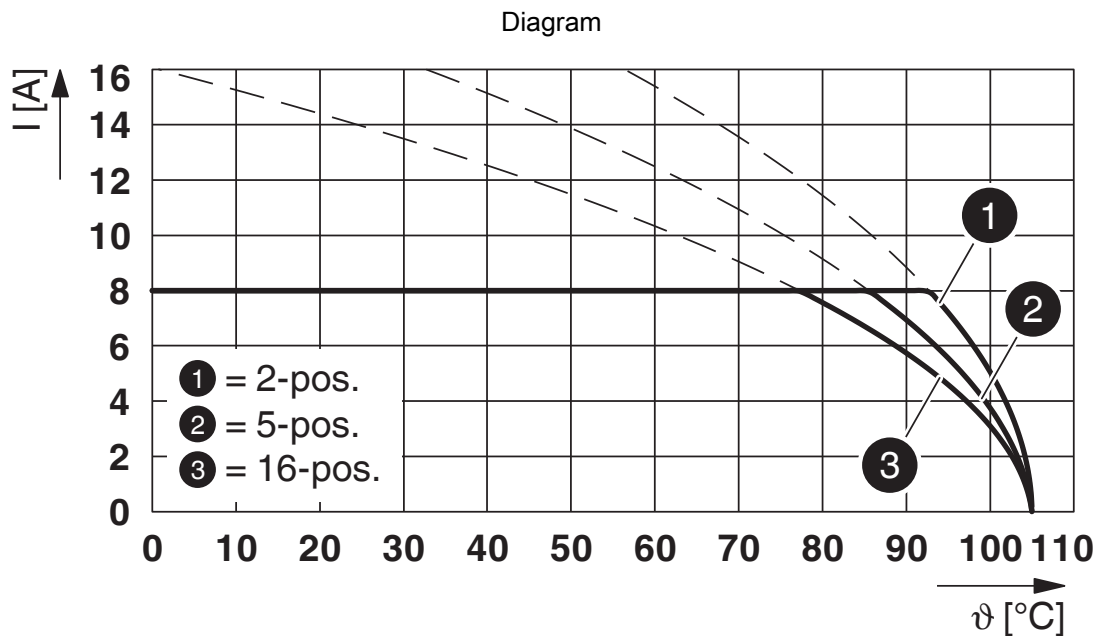

Type: LPC 1,5/...-STF-3,81 with MCV 1,5/...-GF-3,81

Drilling plan/solder pad geometry

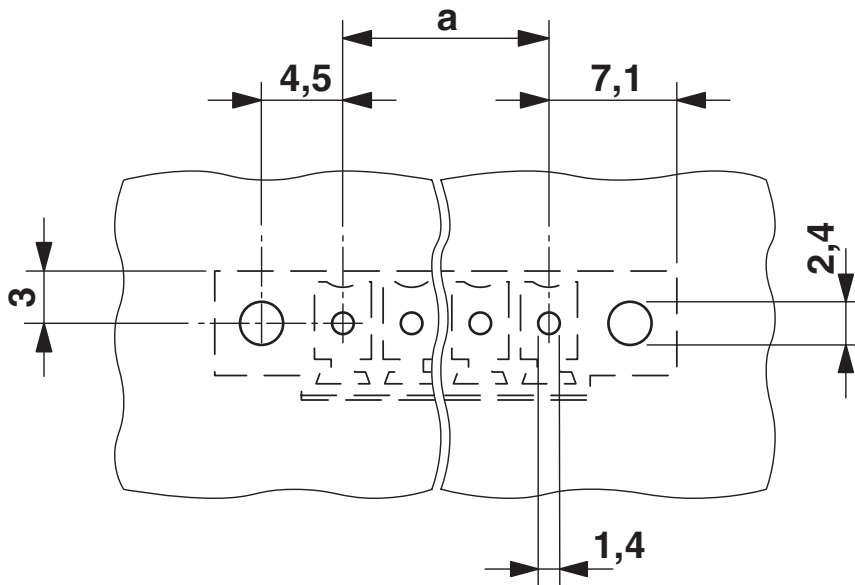

MCV 1,5/10-GF-3,81 - PCB header

1830677

<https://www.phoenixcontact.com/in/products/1830677>

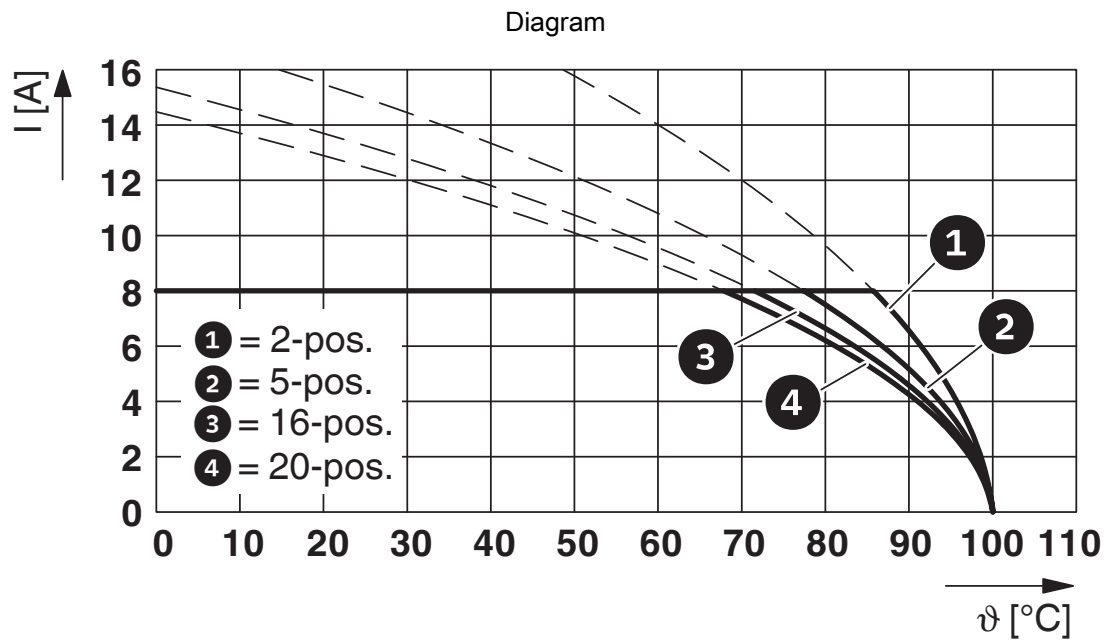

Type: FMC 1,5/...-STF-3,81 with MCV 1,5/...-GF-3,81

MCV 1,5/10-GF-3,81 - PCB header



1830677

<https://www.phoenixcontact.com/in/products/1830677>

Approvals

 CSA Approval ID: 13631				
	Nominal Voltage U_N	Nominal Current I_N	Cross Section AWG	Cross Section mm^2
	300 V	8 A	-	-
	300 V	8 A	-	-

 IECEE CB Scheme Approval ID: DE1-60987-B1B2				
	Nominal Voltage U_N	Nominal Current I_N	Cross Section AWG	Cross Section mm^2
	160 V	8 A	-	-

 EAC Approval ID: B.01687				
----------------------------------------------------------------------------------------------------------------------	--	--	--	--

 cULus Recognized Approval ID: E60425-20110128				
	Nominal Voltage U_N	Nominal Current I_N	Cross Section AWG	Cross Section mm^2
	300 V	8 A	-	-
	300 V	8 A	-	-

 VDE Zeichengenehmigung Approval ID: 40011723				
	Nominal Voltage U_N	Nominal Current I_N	Cross Section AWG	Cross Section mm^2
	160 V	8 A	-	-

MCV 1,5/10-GF-3,81 - PCB header



1830677

<https://www.phoenixcontact.com/in/products/1830677>

Classifications

ECLASS

ECLASS-11.0	27460201
ECLASS-12.0	27460201
ECLASS-13.0	27460201

ETIM

ETIM 8.0	EC002637
----------	----------

UNSPSC

UNSPSC 21.0	39121400
-------------	----------

MCV 1,5/10-GF-3,81 - PCB header

1830677

<https://www.phoenixcontact.com/in/products/1830677>



Environmental Product Compliance

China RoHS	Environmentally friendly use period: unlimited = EFUP-e
	No hazardous substances above threshold values

MCV 1,5/10-GF-3,81 - PCB header

1830677

<https://www.phoenixcontact.com/in/products/1830677>



Accessories

SK 3,81/2,8:FORTL.ZAHLEN - Marker card

0804109

<https://www.phoenixcontact.com/in/products/0804109>



Marker card, white, labeled, horizontal: consecutive numbers 1 ... 10, 11 ... 20, etc. up to 91 ... (99)100, mounting type: adhesive, for terminal block width: 3.81 mm, lettering field size: 3.81 x 2.8 mm

CP-MSTB - Coding profile

1734634

<https://www.phoenixcontact.com/in/products/1734634>



Coding profile, is inserted into the slot on the plug or inverted header, red insulating material

MCV 1,5/10-GF-3,81 - PCB header

1830677

<https://www.phoenixcontact.com/in/products/1830677>



FMC 1,5/10-STF-3,81 - Printed-circuit board connector

1748435

<https://www.phoenixcontact.com/in/products/1748435>



PCB connector, nominal cross section: 1.5 mm², color: green, nominal current: 8 A, rated voltage (III/2): 160 V, contact surface: Tin, type of contact: Socket, number of potentials: 10, number of rows: 1, number of positions: 10, number of connections: 10, product range: FMC 1,5/..-STF, pitch: 3.81 mm, connection method: Push-in spring connection, conductor/PCB connection direction: 0 °, plug-in system: COMBICON MC 1,5, locking: Screw locking, mounting: Screw flange, type of packaging: packed in cardboard

MC 1,5/10-STF-3,81 - PCB connector

1827787

<https://www.phoenixcontact.com/in/products/1827787>

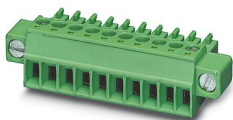

PCB connector, nominal cross section: 1.5 mm², color: green, nominal current: 8 A, rated voltage (III/2): 160 V, contact surface: Tin, type of contact: Socket, number of potentials: 10, number of rows: 1, number of positions: 10, number of connections: 10, product range: MC 1,5/..-STF, pitch: 3.81 mm, connection method: Screw connection with tension sleeve, screw head form: L Slotted, conductor/PCB connection direction: 0 °, plug-in system: COMBICON MC 1,5, locking: Screw locking, mounting: Screw flange, type of packaging: packed in cardboard

MCV 1,5/10-GF-3,81 - PCB header

1830677

<https://www.phoenixcontact.com/in/products/1830677>



MCVR 1,5/10-STF-3,81 - PCB connector

1828427

<https://www.phoenixcontact.com/in/products/1828427>

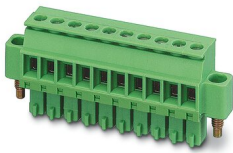

PCB connector, nominal cross section: 1.5 mm², color: green, nominal current: 8 A, rated voltage (III/2): 160 V, contact surface: Tin, type of contact: Socket, number of potentials: 10, number of rows: 1, number of positions: 10, number of connections: 10, product range: MCVR 1,5/..-STF, pitch: 3.81 mm, connection method: Screw connection with tension sleeve, screw head form: L Slotted, conductor/PCB connection direction: 90 °, plug-in system: COMBICON MC 1,5, locking: Screw locking, mounting: Screw flange, type of packaging: packed in cardboard

MCVW 1,5/10-STF-3,81 - PCB connector

1828579

<https://www.phoenixcontact.com/in/products/1828579>



PCB connector, nominal cross section: 1.5 mm², color: green, nominal current: 8 A, rated voltage (III/2): 160 V, contact surface: Tin, type of contact: Socket, number of potentials: 10, number of rows: 1, number of positions: 10, number of connections: 10, product range: MCVW 1,5/..-STF, pitch: 3.81 mm, connection method: Screw connection with tension sleeve, screw head form: L Slotted, conductor/PCB connection direction: -90 °, plug-in system: COMBICON MC 1,5, locking: Screw locking, mounting: Screw flange, type of packaging: packed in cardboard

MCV 1,5/10-GF-3,81 - PCB header

1830677

<https://www.phoenixcontact.com/in/products/1830677>

FRONT-MC 1,5/10-STF-3,81 - Printed-circuit board connector

1850932

<https://www.phoenixcontact.com/in/products/1850932>

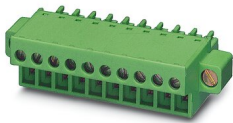

PCB connector, nominal cross section: 1.5 mm², color: green, nominal current: 8 A, rated voltage (III/2): 160 V, contact surface: Tin, type of contact: Socket, number of potentials: 10, number of rows: 1, number of positions: 10, number of connections: 10, product range: FRONT-MC 1,5/...-STF, pitch: 3.81 mm, connection method: Front screw connection, screw head form: L Slotted, conductor/PCB connection direction: 0 °, plug-in system: COMBICON MC 1,5, locking: Screw locking, mounting: Screw flange, type of packaging: packed in cardboard

FK-MCP 1,5/10-STF-3,81 - PCB connector

1851313

<https://www.phoenixcontact.com/in/products/1851313>

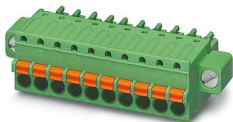

PCB connector, nominal cross section: 1.5 mm², color: green, nominal current: 8 A, rated voltage (III/2): 160 V, contact surface: Tin, type of contact: Socket, number of potentials: 10, number of rows: 1, number of positions: 10, number of connections: 10, product range: FK-MCP 1,5/...-STF, pitch: 3.81 mm, connection method: Push-in spring connection, conductor/PCB connection direction: 0 °, plug-in system: COMBICON MC 1,5, locking: Screw locking, mounting: Screw flange, type of packaging: packed in cardboard

MCV 1,5/10-GF-3,81 - PCB header

1830677

<https://www.phoenixcontact.com/in/products/1830677>



MCC 1/10-STZF-3,81 - PCB connector

1852448

<https://www.phoenixcontact.com/in/products/1852448>



PCB connector, nominal cross section: 1 mm², color: green, nominal current: 8 A, rated voltage (III/2): 160 V, type of contact: Socket, number of potentials: 10, number of rows: 1, number of positions: 10, number of connections: 10, product range: MCC 1/..-STZF, pitch: 3.81 mm, connection method: Crimp connection, conductor/PCB connection direction: 0 °, plug-in system: COMBICON MC 1,5, locking: Screw locking, mounting: Screw flange, type of packaging: packed in cardboard, Corresponding female crimp contacts with current [A] and conductor cross section range [mm²] data: 5A/MCC-MT 0,2-0,35 (1859988); 8A/MCC-MT 0,5-1,0 (1859991)

QC 0,5/10-STF-3,81 - Printed-circuit board connector

1897623

<https://www.phoenixcontact.com/in/products/1897623>

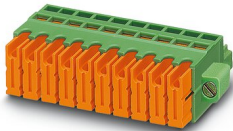

PCB connector, nominal cross section: 0.5 mm², color: green, nominal current: 6 A, rated voltage (III/2): 200 V, contact surface: Tin, type of contact: Socket, number of potentials: 10, number of rows: 1, number of positions: 10, number of connections: 10, product range: QC 0,5/..-STF, pitch: 3.81 mm, connection method: Displacement connection, conductor/PCB connection direction: 0 °, plug-in system: COMBICON MC 1,5, locking: Screw locking, mounting: Screw flange, type of packaging: packed in cardboard

Phoenix Contact 2023 © - all rights reserved
<https://www.phoenixcontact.com>

PHOENIX CONTACT (I) Pvt. Ltd.
A-58/2, Okhla Industrial Area, Phase - II, New Delhi-110 020

+91.1275.71420
info@phoenixcontact.co.in