

# IMCV 1,5/11-G-3,81 - PCB header



1875519

<https://www.phoenixcontact.com/ae/products/1875519>

Please be informed that the data shown in this PDF document is generated from our Online Catalog. Please find the complete data in the user documentation. Our General Terms of Use for Downloads are valid.

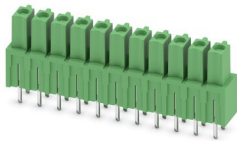

PCB headers, nominal cross section: 1.5 mm<sup>2</sup>, color: green, nominal current: 8 A, rated voltage (III/2): 160 V, contact surface: Tin, type of contact: Socket, number of potentials: 11, number of rows: 1, number of positions: 11, number of connections: 11, product range: IMCV 1,5/..-G, pitch: 3.81 mm, mounting: Wave soldering, pin layout: Linear pinning, solder pin [P]: 3.5 mm, number of solder pins per potential: 2, plug-in system: COMBICON MC 1,5, Pin connector pattern alignment: Standard, locking: without, mounting: without, type of packaging: packed in cardboard

## Your advantages

- Well-known mounting principle allows worldwide use
- Vertical connection enables multi-row arrangement on the PCB
- Inverted header with socket contacts for touch-proof device outputs or PCB/PCB connections

## Commercial Data

Item number	1875519
Packing unit	50 pc
Minimum order quantity	50 pc
Sales Key	AA
Product Key	AABSIB
Catalog Page	Page 239 (C-1-2013)
GTIN	4017918134013
Weight per Piece (including packing)	4.01 g
Weight per Piece (excluding packing)	3.67 g
Customs tariff number	85366930
Country of origin	PL

## Technical Data

### Product properties

Type	Inverted
Product line	COMBICON Connectors S
Product type	PCB headers
Product family	IMCV 1,5/...-G
Number of positions	11
Pitch	3.81 mm
Number of connections	11
Number of rows	1
Mounting flange	without
Number of potentials	11
Pin layout	Linear pinning
Solder pins per potential	2

### Electrical properties

Nominal current $I_N$	8 A
Nominal voltage $U_N$	160 V
Degree of pollution	3
Contact resistance	2.2 mΩ
Rated voltage (III/3)	160 V
Rated surge voltage (III/3)	2.5 kV
Rated voltage (III/2)	160 V
Rated surge voltage (III/2)	2.5 kV
Rated voltage (II/2)	320 V
Rated surge voltage (II/2)	2.5 kV

### Mounting

Mounting type	Wave soldering
Pin layout	Linear pinning

### Material specifications

#### Material data - contact

Note	WEEE/RoHS-compliant, free of whiskers according to IEC 60068-2-82/JEDEC JESD 201
Contact material	Cu alloy
Surface characteristics	hot-dip tin-plated
Metal surface contact area (top layer)	Tin (4 - 8 μm Sn)
Metal surface soldering area (top layer)	Tin (4 - 8 μm Sn)

#### Material data - housing

Color (Housing)	green (6021)
Insulating material	PA

# IMCV 1,5/11-G-3,81 - PCB header

1875519

<https://www.phoenixcontact.com/ae/products/1875519>

Insulating material group	I
CTI according to IEC 60112	600
Flammability rating according to UL 94	V0
Glow wire flammability index GWFI according to EN 60695-2-12	850
Glow wire ignition temperature GWIT according to EN 60695-2-13	775
Temperature for the ball pressure test according to EN 60695-10-2	125 °C

## Dimensions

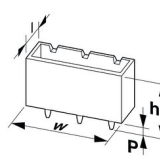
Dimensional drawing	
Pitch	3.81 mm
Width [w]	42.7 mm
Height [h]	18 mm
Length [l]	6.85 mm
Installed height	14.5 mm
Solder pin length [P]	3.5 mm
Pin dimensions	0.62 x 1.12 mm

## PCB design

Pin spacing	3.81 mm
Hole diameter	1.2 mm

## Mechanical tests

### Test for conductor damage and slackening

Specification	IEC 60999-1:1999-11
Result	Test passed

### Pull-out test

Specification	IEC 60999-1:1999-11
Conductor cross section/conductor type/tractive force setpoint/actual value	0.14 mm <sup>2</sup> / solid / > 10 N
	0.14 mm <sup>2</sup> / flexible / > 10 N
	1.5 mm <sup>2</sup> / solid / > 40 N
	1.5 mm <sup>2</sup> / flexible / > 40 N

### Insertion and withdrawal forces

Result	Test passed
No. of cycles	25
Insertion strength per pos. approx.	7 N
Withdraw strength per pos. approx.	3 N

1875519

<https://www.phoenixcontact.com/ae/products/1875519>

## Torque test

Specification	IEC 60999-1:1999-11
---------------	---------------------

## Contact holder in insert

Specification	IEC 60512-15-1:2008-05
Contact holder in insert Requirements >20 N	Test passed

## Resistance of inscriptions

Specification	IEC 60068-2-70:1995-12
Result	Test passed

## Polarization and coding

Specification	IEC 60512-13-5:2006-02
Result	Test passed

## Visual inspection

Specification	IEC 60512-1-1:2002-02
Result	Test passed

## Dimension check

Specification	IEC 60512-1-2:2002-02
Result	Test passed

## Electrical tests

### Thermal test | Test group C

Specification	IEC 60512-5-1:2002-02
Tested number of positions	16

### Insulation resistance

Specification	IEC 60512-3-1:2002-02
Insulation resistance, neighboring positions	> 5 MΩ

### Air clearances and creepage distances |

Specification	IEC 60664-1:2007-04
Insulating material group	I
Comparative tracking index (IEC 60112)	CTI 600
Rated insulation voltage (III/3)	160 V
Rated surge voltage (III/3)	2.5 kV
minimum clearance value - non-homogenous field (III/3)	1.5 mm
minimum creepage distance (III/3)	2 mm
Rated insulation voltage (III/2)	160 V
Rated surge voltage (III/2)	2.5 kV
minimum clearance value - non-homogenous field (III/2)	1.5 mm
minimum creepage distance (III/2)	1.5 mm
Rated insulation voltage (II/2)	320 V
Rated surge voltage (II/2)	2.5 kV

1875519

<https://www.phoenixcontact.com/ae/products/1875519>

minimum clearance value - non-homogenous field (II/2)	1.5 mm
minimum creepage distance (II/2)	1.6 mm

## Environmental and real-life conditions

### Vibration test

Specification	IEC 60068-2-6:2007-12
Frequency	10 - 150 - 10 Hz
Sweep speed	1 octave/min
Amplitude	0.35 mm (10 Hz ... 60.1 Hz)
Sweep speed	5g (60.1 Hz ... 150 Hz)
Test duration per axis	2.5 h

### Durability test

Specification	IEC 60512-9-1:2010-03
Impulse withstand voltage at sea level	2.95 kV
Contact resistance $R_1$	2.2 m $\Omega$
Contact resistance $R_2$	2.6 m $\Omega$
Insertion/withdrawal cycles	25
Insulation resistance, neighboring positions	> 5 M $\Omega$

### Climatic test

Specification	ISO 6988:1985-02
Corrosive stress	0.2 dm <sup>3</sup> SO <sub>2</sub> on 300 dm <sup>3</sup> /40 °C/1 cycle
Thermal stress	105 °C/168 h
Power-frequency withstand voltage	1.39 kV

### Ambient conditions

Ambient temperature (operation)	-40 °C ... 105 °C (Depending on the current carrying capacity/derating curve)
Ambient temperature (storage/transport)	-40 °C ... 70 °C
Relative humidity (storage/transport)	30 % ... 70 %
Ambient temperature (assembly)	-5 °C ... 100 °C

Drawings

Drilling plan/solder pad geometry

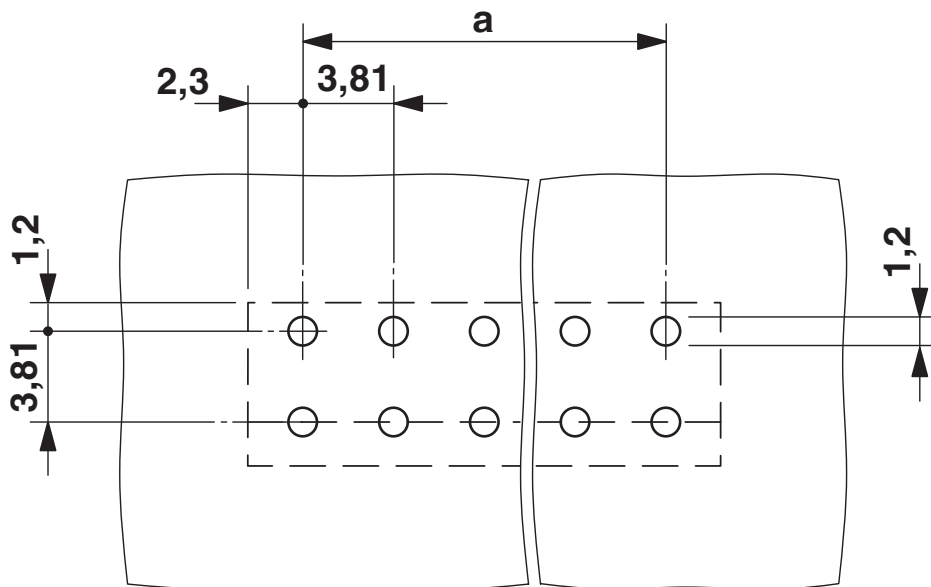

Dimensional drawing

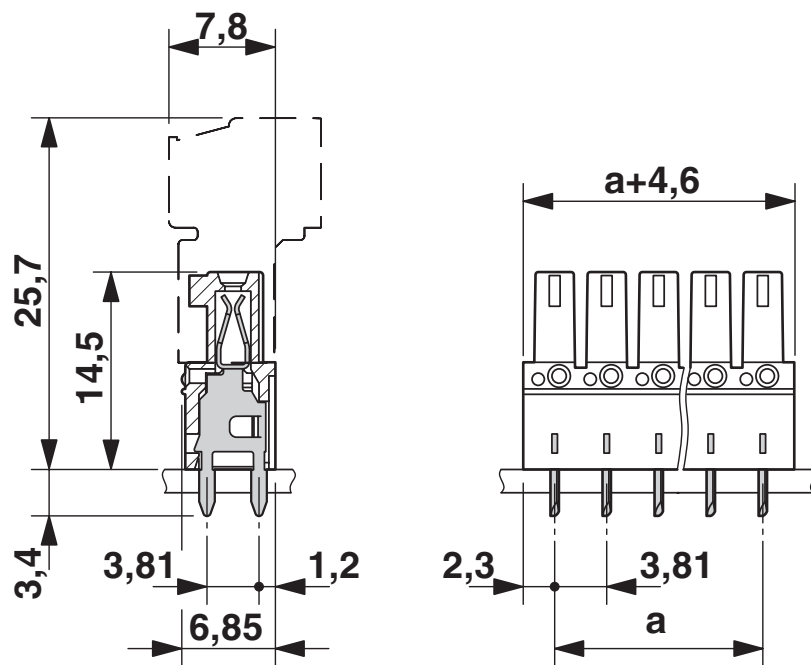

# IMCV 1,5/11-G-3,81 - PCB header



1875519

<https://www.phoenixcontact.com/ae/products/1875519>

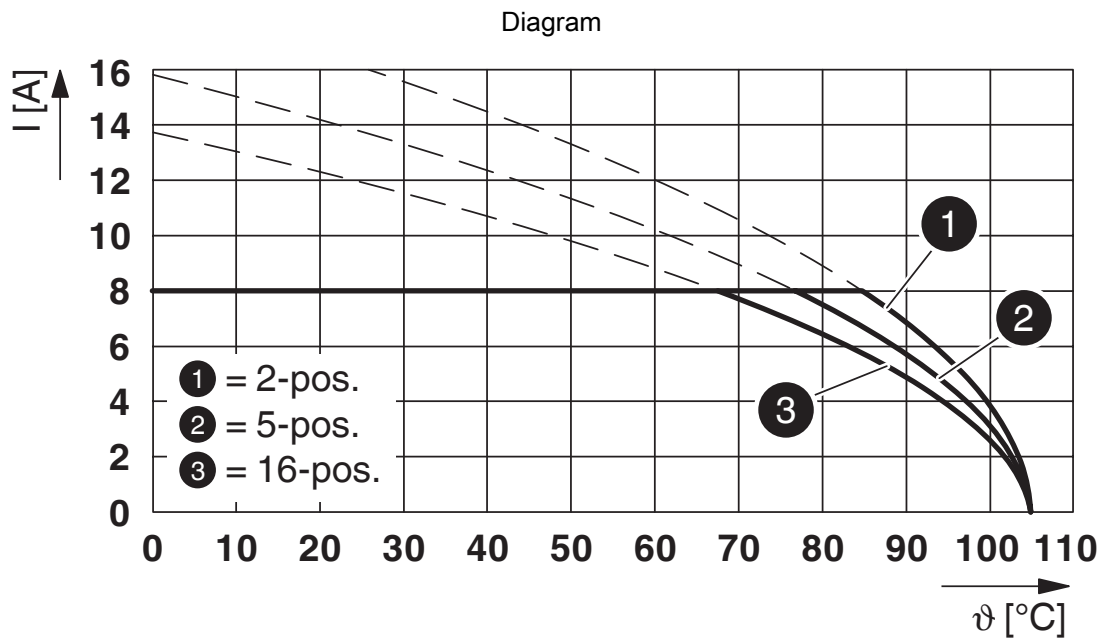

Type: IMC 1,5/...-ST-3,81 with IMCV 1,5/...-G-3,81

# IMCV 1,5/11-G-3,81 - PCB header



1875519

<https://www.phoenixcontact.com/ae/products/1875519>

## Approvals

To download certificates, visit the product detail page: <https://www.phoenixcontact.com/ae/products/1875519>

 <b>IECEE CB Scheme</b> Approval ID: DE1-60987-B1B2				
	Nominal Voltage $U_N$	Nominal Current $I_N$	Cross Section AWG	Cross Section $\text{mm}^2$
	160 V	8 A	-	-

 <b>EAC</b> Approval ID: B.01687				
--	--	--	--	--

 <b>cULus Recognized</b> Approval ID: E60425-20110128				
	Nominal Voltage $U_N$	Nominal Current $I_N$	Cross Section AWG	Cross Section $\text{mm}^2$
Use group B	300 V	8 A	-	-
Use group D	300 V	8 A	-	-

 <b>VDE Zeichengenehmigung</b> Approval ID: 40011723				
	Nominal Voltage $U_N$	Nominal Current $I_N$	Cross Section AWG	Cross Section $\text{mm}^2$
	160 V	8 A	-	-



# IMCV 1,5/11-G-3,81 - PCB header



1875519

<https://www.phoenixcontact.com/ae/products/1875519>

## Classifications

### ECLASS

ECLASS-11.0	27460201
ECLASS-12.0	27460201
ECLASS-13.0	27460201

### ETIM

ETIM 8.0	EC002637
----------	----------

### UNSPSC

UNSPSC 21.0	39121400
-------------	----------

# IMCV 1,5/11-G-3,81 - PCB header

1875519

<https://www.phoenixcontact.com/ae/products/1875519>



## Environmental Product Compliance

China RoHS	Environmentally friendly use period: unlimited = EFUP-e
	No hazardous substances above threshold values

# IMCV 1,5/11-G-3,81 - PCB header

1875519

<https://www.phoenixcontact.com/ae/products/1875519>



## Accessories

### SK 3,81/2,8:FORTL.ZAHLEN - Marker card

0804109

<https://www.phoenixcontact.com/ae/products/0804109>

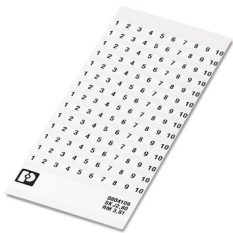

Marker card, white, labeled, horizontal: consecutive numbers 1 ... 10, 11 ... 20, etc. up to 91 ... (99)100, mounting type: adhesive, for terminal block width: 3.81 mm, lettering field size: 3.81 x 2.8 mm

---

### MCDV 1,5/11-G-3,81 - PCB header

1830499

<https://www.phoenixcontact.com/ae/products/1830499>



PCB headers, nominal cross section: 1.5 mm<sup>2</sup>, color: green, nominal current: 8 A, rated voltage (III/2): 160 V, contact surface: Tin, type of contact: Pin, number of potentials: 22, number of rows: 2, number of positions: 11, number of connections: 22, product range: MCDV 1,5/..-G, pitch: 3.81 mm, mounting: Wave soldering, pin layout: Linear pinning, solder pin [P]: 3.4 mm, number of solder pins per potential: 1, plug-in system: COMBICON MC 1,5, Pin connector pattern alignment: Standard, locking: without, mounting: without, type of packaging: packed in cardboard, In combination with MCV plug components, both an MCVW and an MCVR plug must be used.

# IMCV 1,5/11-G-3,81 - PCB header

1875519

<https://www.phoenixcontact.com/ae/products/1875519>



## MCDV 1,5/11-G1-3,81 - PCB header

1847822

<https://www.phoenixcontact.com/ae/products/1847822>

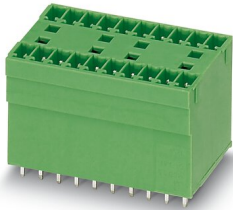

PCB headers, nominal cross section: 1.5 mm<sup>2</sup>, color: green, nominal current: 8 A, rated voltage (III/2): 160 V, contact surface: Tin, type of contact: Pin, number of potentials: 22, number of rows: 2, number of positions: 11, number of connections: 22, product range: MCDV 1,5/...-G1, pitch: 3.81 mm, mounting: Wave soldering, pin layout: Linear pinning, solder pin [P]: 3.4 mm, number of solder pins per potential: 1, plug-in system: COMBICON MC 1,5, Pin connector pattern alignment: Standard, locking: without, mounting: without, type of packaging: packed in cardboard, In combination with MCV plug components, both an MCVW and an MCVR plug must be used.

## MCD 1,5/11-G1-3,81 - PCB header

1843169

<https://www.phoenixcontact.com/ae/products/1843169>

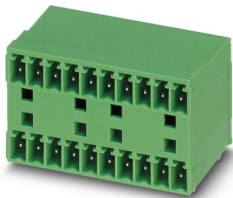

PCB headers, nominal cross section: 1.5 mm<sup>2</sup>, color: green, nominal current: 8 A, rated voltage (III/2): 160 V, contact surface: Tin, type of contact: Pin, number of potentials: 22, number of rows: 2, number of positions: 11, number of connections: 22, product range: MCD 1,5/...-G1, pitch: 3.81 mm, mounting: Wave soldering, pin layout: Linear pinning, solder pin [P]: 3.5 mm, number of solder pins per potential: 1, plug-in system: COMBICON MC 1,5, Pin connector pattern alignment: Standard, locking: without, mounting: without, type of packaging: packed in cardboard, In combination with MCV plug components, both an MCVW and an MCVR plug must be used.

# IMCV 1,5/11-G-3,81 - PCB header

1875519

<https://www.phoenixcontact.com/ae/products/1875519>



## MCD 1,5/11-G-3,81 - PCB header

1830046

<https://www.phoenixcontact.com/ae/products/1830046>

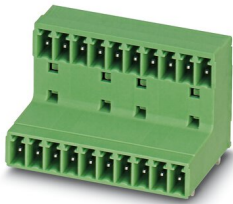

PCB headers, nominal cross section: 1.5 mm<sup>2</sup>, color: green, nominal current: 8 A, rated voltage (III/2): 160 V, contact surface: Tin, type of contact: Pin, number of potentials: 22, number of rows: 2, number of positions: 11, number of connections: 22, product range: MCD 1,5/..-G, pitch: 3.81 mm, mounting: Wave soldering, pin layout: Linear pinning, solder pin [P]: 3.5 mm, number of solder pins per potential: 1, plug-in system: COMBICON MC 1,5, Pin connector pattern alignment: Standard, locking: without, mounting: without, type of packaging: packed in cardboard, In combination with MCV plug components, both an MCVW and an MCVR plug must be used.

---

## IMC 1,5/11-ST-3,81 - Printed-circuit board connector

1857977

<https://www.phoenixcontact.com/ae/products/1857977>



PCB connector, nominal cross section: 1.5 mm<sup>2</sup>, color: green, nominal current: 8 A, rated voltage (III/2): 160 V, contact surface: Tin, type of contact: Pin, number of potentials: 11, number of rows: 1, number of positions: 11, number of connections: 11, product range: IMC 1,5/..-ST, pitch: 3.81 mm, connection method: Screw connection with tension sleeve, screw head form: L Slotted, conductor/PCB connection direction: 0 °, plug-in system: COMBICON MC 1,5, locking: without, mounting: without, type of packaging: packed in cardboard

# IMCV 1,5/11-G-3,81 - PCB header

1875519

<https://www.phoenixcontact.com/ae/products/1875519>



## MCVK 1,5/11-G-3,81 - DIN rail connector

1832824

<https://www.phoenixcontact.com/ae/products/1832824>

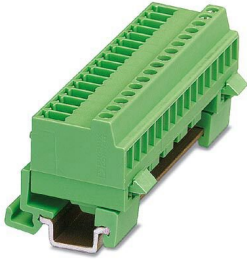

DIN rail connector, nominal cross section: 1.5 mm<sup>2</sup>, color: green, nominal current: 8 A, rated voltage (III/2): 160 V, contact surface: Tin, type of contact: Pin, number of potentials: 11, number of rows: 1, number of positions: 11, number of connections: 11, product range: MCVK 1,5/..-G, pitch: 3.81 mm, connection method: Screw connection with tension sleeve, screw head form: L Slotted, mounting: DIN rail, conductor/PCB connection direction: 0 °, plug-in system: COMBICON MC 1,5, locking: without, mounting: without, type of packaging: packed in cardboard

## MC 1,5/11-G-3,81 - PCB header

1803361

<https://www.phoenixcontact.com/ae/products/1803361>

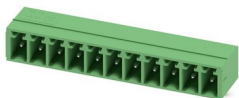

PCB headers, nominal cross section: 1.5 mm<sup>2</sup>, color: green, nominal current: 8 A, rated voltage (III/2): 160 V, contact surface: Tin, type of contact: Pin, number of potentials: 11, number of rows: 1, number of positions: 11, number of connections: 11, product range: MC 1,5/..-G, pitch: 3.81 mm, mounting: Wave soldering, pin layout: Linear pinning, solder pin [P]: 3.4 mm, number of solder pins per potential: 1, plug-in system: COMBICON MC 1,5, Pin connector pattern alignment: Standard, locking: without, mounting: without, type of packaging: packed in cardboard

Phoenix Contact 2023 © - all rights reserved  
<https://www.phoenixcontact.com>

PHOENIX CONTACT Middle East FZ LLC  
1201N-1206N, Dubai Science Park Towers – North  
P.O. Box 345002, Dubai, United Arab Emirates  
(+971) 4 437-0324  
[info-me@phoenixcontact.com](mailto:info-me@phoenixcontact.com)