

# ST 2,5-TWIN-TG/1P - Disconnect terminal block



3040847

<https://www.phoenixcontact.com/in/products/3040847>

Please be informed that the data shown in this PDF document is generated from our Online Catalog. Please find the complete data in the user documentation. Our General Terms of Use for Downloads are valid.



Disconnect terminal block, The max. load current must not be exceeded by the total current of all connected conductors.

Current and voltage are determined by the plug used., nom. voltage: 400 V, nominal current: 20 A, 1st level connection left, connection method: Spring-cage/plug-in connection, Rated cross section: 2.5 mm<sup>2</sup>, cross section: 0.08 mm<sup>2</sup> - 4 mm<sup>2</sup>, mounting: NS 35/7,5, NS 35/15, color: gray

## Your advantages

- Tested for railway applications
- Design width of just 5.2 mm

## Commercial Data

Item number	3040847
Packing unit	50 pc
Minimum order quantity	50 pc
Sales Key	BE2
Product Key	BE2143
Catalog Page	Page 310 (C-1-2019)
GTIN	4017918907327
Weight per Piece (including packing)	9.66 g
Weight per Piece (excluding packing)	9.66 g
Customs tariff number	85369010
Country of origin	PL

# ST 2,5-TWIN-TG/1P - Disconnect terminal block



3040847

<https://www.phoenixcontact.com/in/products/3040847>

## Technical Data

### Notes

General	The max. load current must not be exceeded by the total current of all connected conductors. Current and voltage are determined by the plug used.
---------	--

### Product properties

Product type	Disconnect terminal block
Area of application	Railway industry
	Machine building
	Plant engineering
Number of connections	2
Number of rows	1
Potentials	1

### Insulation characteristics

Overvoltage category	III
Degree of pollution	3

### Electrical properties

Rated surge voltage	6 kV
Maximum power dissipation for nominal condition	0.77 W

### Connection data

Number of connections per level	3
Nominal cross section	2.5 mm <sup>2</sup>

#### 1st level connection left

Stripping length	8 mm ... 10 mm
Internal cylindrical gage	A3
Connection in acc. with standard	IEC 61984
Conductor cross section rigid	0.08 mm <sup>2</sup> ... 4 mm <sup>2</sup>
Cross section AWG	28 ... 12 (converted acc. to IEC)
Conductor cross section flexible	0.08 mm <sup>2</sup> ... 2.5 mm <sup>2</sup>
Conductor cross section, flexible [AWG]	28 ... 14 (converted acc. to IEC)
Conductor cross-section flexible (ferrule without plastic sleeve)	0.14 mm <sup>2</sup> ... 2.5 mm <sup>2</sup>
Flexible conductor cross section (ferrule with plastic sleeve)	0.14 mm <sup>2</sup> ... 2.5 mm <sup>2</sup>
2 conductors with the same cross section, flexible, with TWIN ferrule with plastic sleeve	0.5 mm <sup>2</sup>
Nominal current	20 A
Maximum load current	20 A (with 4 mm <sup>2</sup> conductor cross section)
Nominal voltage	400 V (voltage is determined by the plug used)
Nominal cross section	2.5 mm <sup>2</sup>

# ST 2,5-TWIN-TG/1P - Disconnect terminal block



3040847

<https://www.phoenixcontact.com/in/products/3040847>

## Dimensions

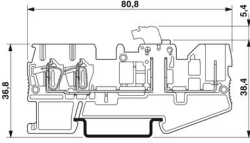
Dimensional drawing	
Width	5.2 mm
End cover width	2.2 mm
Height NS 35/15	44 mm
Height NS 35/7,5	36.5 mm
Length	81 mm

## Material specifications

Color	gray
Flammability rating according to UL 94	V0
Insulating material group	I
Insulating material	PA
Static insulating material application in cold	-60 °C
Temperature index of insulation material (DIN EN 60216-1 (VDE 0304-21))	130 °C
Relative insulation material temperature index (Elec., UL 746 B)	130 °C
Fire protection for rail vehicles (DIN EN 45545-2) R22	HL 1 - HL 3
Fire protection for rail vehicles (DIN EN 45545-2) R23	HL 1 - HL 3
Fire protection for rail vehicles (DIN EN 45545-2) R24	HL 1 - HL 3
Fire protection for rail vehicles (DIN EN 45545-2) R26	HL 1 - HL 3
Calorimetric heat release NFPA 130 (ASTM E 1354)	28 MJ/kg
Surface flammability NFPA 130 (ASTM E 162)	passed
Specific optical density of smoke NFPA 130 (ASTM E 662)	passed
Smoke gas toxicity NFPA 130 (SMP 800C)	passed

## Electrical tests

### Surge voltage test

Test voltage setpoint	7.3 kV
Result	Test passed
Short-time withstand current 2.5 mm <sup>2</sup>	0.3 kA
Result	Test passed

### Power-frequency withstand voltage

Test voltage setpoint	1.89 kV
Result	Test passed

## Mechanical properties

### Mechanical data

# ST 2,5-TWIN-TG/1P - Disconnect terminal block



3040847

<https://www.phoenixcontact.com/in/products/3040847>

Open side panel	Yes
-----------------	-----

## Mechanical tests

### Attachment on the carrier

DIN rail/fixing support	NS 35
Test force setpoint	1 N
Result	Test passed

## Environmental and real-life conditions

### Needle-flame test

Time of exposure	30 s
Result	Test passed

### Oscillation/broadband noise

Specification	DIN EN 50155 (VDE 0115-200):2008-03
Spectrum	Service life test category 1, class B, body mounted
Frequency	$f_1 = 5 \text{ Hz}$ to $f_2 = 150 \text{ Hz}$
ASD level	$0.964 \text{ (m/s}^2\text{)}^2\text{/Hz}$
Acceleration	0.58g
Test duration per axis	5 h
Test directions	X-, Y- and Z-axis
Result	Test passed

### Shocks

Specification	DIN EN 50155 (VDE 0115-200):2008-03
Pulse shape	Half-sine
Acceleration	5g
Shock duration	30 ms
Number of shocks per direction	3
Test directions	X-, Y- and Z-axis (pos. and neg.)
Result	Test passed

### Ambient conditions

Ambient temperature (operation)	-60 °C ... 105 °C (max. short-term operating temperature RTI Elec.)
Ambient temperature (storage/transport)	-25 °C ... 60 °C (for a short time, not exceeding 24 h, -60 °C to +70 °C)
Ambient temperature (assembly)	-5 °C ... 70 °C
Ambient temperature (actuation)	-5 °C ... 70 °C
Permissible humidity (storage/transport)	30 % ... 70 %

## Standards and regulations

Connection in acc. with standard	IEC 61984
----------------------------------	-----------

## Mounting

# ST 2,5-TWIN-TG/1P - Disconnect terminal block



3040847

<https://www.phoenixcontact.com/in/products/3040847>

Mounting type	NS 35/7,5
	NS 35/15

# ST 2,5-TWIN-TG/1P - Disconnect terminal block

3040847

<https://www.phoenixcontact.com/in/products/3040847>

## Drawings

Diagram

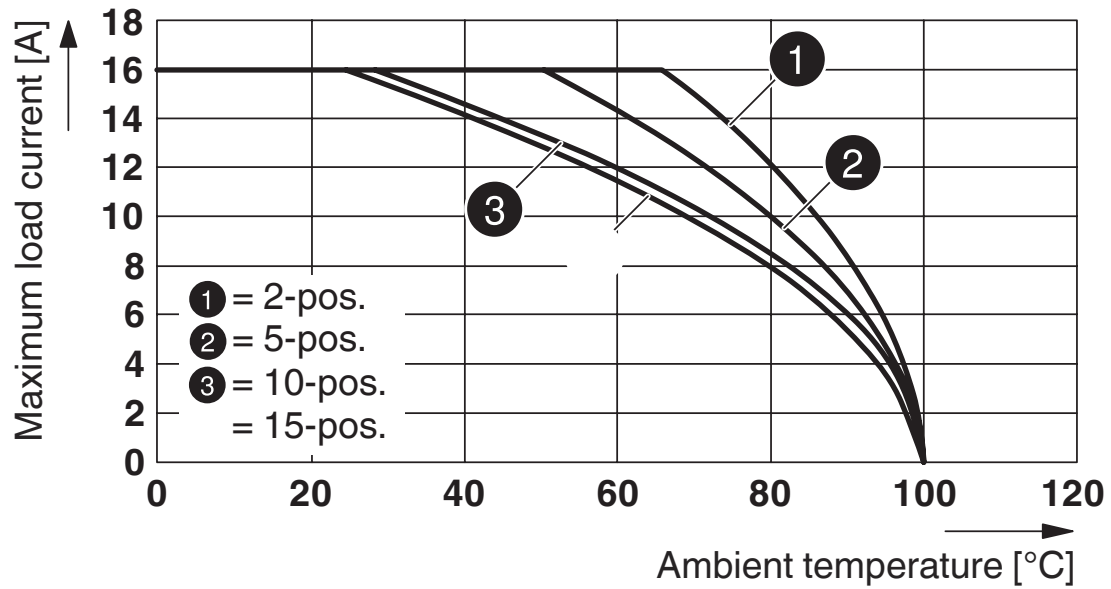

Applies to all male connector variants SP...

Dimensional drawing

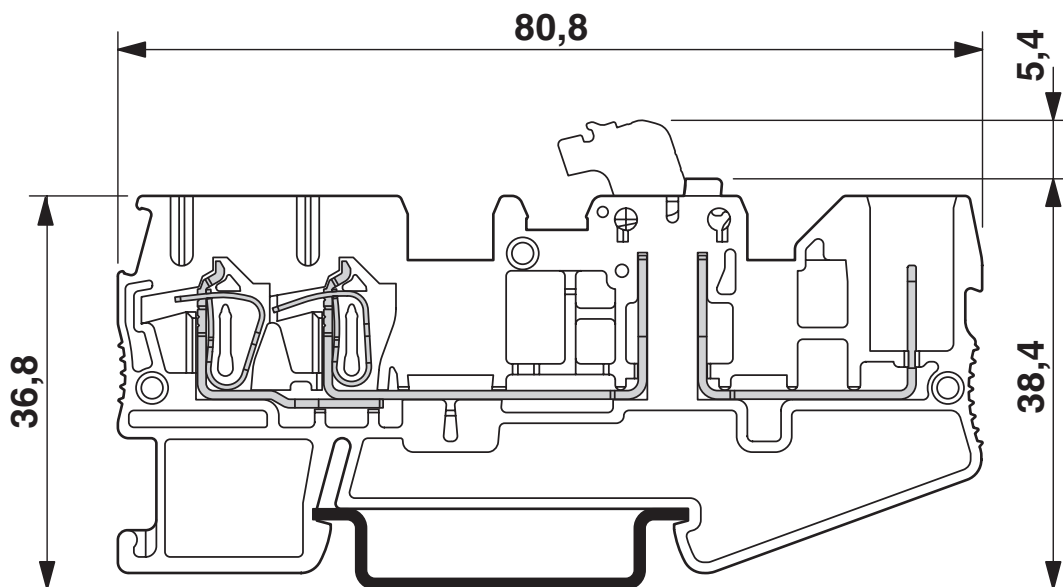

# ST 2,5-TWIN-TG/1P - Disconnect terminal block

3040847

<https://www.phoenixcontact.com/in/products/3040847>

Circuit diagram

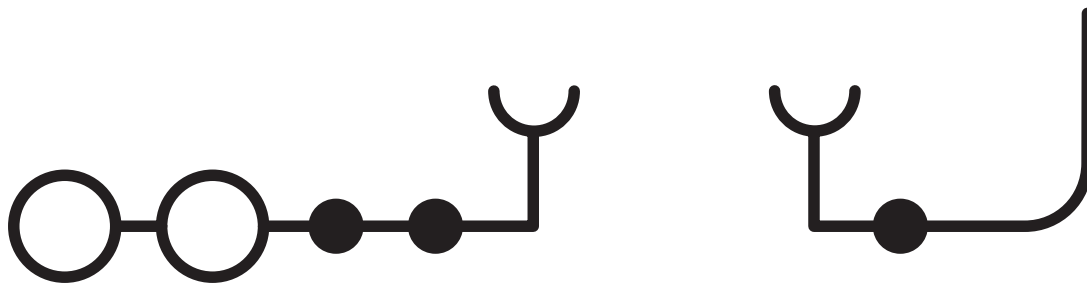

# ST 2,5-TWIN-TG/1P - Disconnect terminal block





3040847

<https://www.phoenixcontact.com/in/products/3040847>

## Approvals

 <b>CSA</b> Approval ID: 13631				
	Nominal Voltage $U_N$	Nominal Current $I_N$	Cross Section AWG	Cross Section $\text{mm}^2$
	300 V	20 A	28 - 12	-
	300 V	10 A	28 - 12	-

 <b>EAC</b> Approval ID: RU C-DE.BL08.B.00644				
---	--	--	--	--

 <b>RS</b> Approval ID: 22.44.01.00083.250				
--	--	--	--	--

 <b>cULus Recognized</b> Approval ID: E60425				
	Nominal Voltage $U_N$	Nominal Current $I_N$	Cross Section AWG	Cross Section $\text{mm}^2$
	300 V	16 A	28 - 12	-
	300 V	16 A	28 - 12	-
	600 V	5 A	28 - 12	-



# ST 2,5-TWIN-TG/1P - Disconnect terminal block



3040847

<https://www.phoenixcontact.com/in/products/3040847>

## Classifications

### ECLASS

ECLASS-11.0	27141126
ECLASS-12.0	27141126

### ETIM

ETIM 8.0	EC000902
----------	----------

### UNSPSC

UNSPSC 21.0	39121400
-------------	----------

# ST 2,5-TWIN-TG/1P - Disconnect terminal block



3040847

<https://www.phoenixcontact.com/in/products/3040847>

## Environmental Product Compliance

China RoHS	Environmentally friendly use period: unlimited = EFUP-e
	No hazardous substances above threshold values

# ST 2,5-TWIN-TG/1P - Disconnect terminal block

3040847

<https://www.phoenixcontact.com/in/products/3040847>

## Accessories

 Note: Applying some accessories below might limit this product.

### FBS 2-5 - Plug-in bridge

3030161

<https://www.phoenixcontact.com/in/products/3030161>



Plug-in bridge, pitch: 5.2 mm, number of positions: 2, length: 23 mm, color: red

 Max. current carrying capacity: 24 A

---

### FBS 3-5 - Plug-in bridge

3030174

<https://www.phoenixcontact.com/in/products/3030174>



Plug-in bridge, pitch: 5.2 mm, number of positions: 3, length: 23 mm, color: red

 Max. current carrying capacity: 24 A

# ST 2,5-TWIN-TG/1P - Disconnect terminal block

3040847

<https://www.phoenixcontact.com/in/products/3040847>

## FBS 4-5 - Plug-in bridge

3030187

<https://www.phoenixcontact.com/in/products/3030187>



Plug-in bridge, pitch: 5.2 mm, number of positions: 4, length: 23 mm, color: red

 Max. current carrying capacity: 24 A

---

## FBS 5-5 - Plug-in bridge

3030190

<https://www.phoenixcontact.com/in/products/3030190>



Plug-in bridge, pitch: 5.2 mm, number of positions: 5, length: 23 mm, color: red

 Max. current carrying capacity: 24 A

# ST 2,5-TWIN-TG/1P - Disconnect terminal block

3040847

<https://www.phoenixcontact.com/in/products/3040847>

## FBS 10-5 - Plug-in bridge

3030213

<https://www.phoenixcontact.com/in/products/3030213>



Plug-in bridge, pitch: 5.2 mm, number of positions: 10, length: 23 mm, color: red

 Max. current carrying capacity: 24 A

---

## FBS 20-5 - Plug-in bridge

3030226

<https://www.phoenixcontact.com/in/products/3030226>



Plug-in bridge, pitch: 5.2 mm, number of positions: 20, color: red

 Max. current carrying capacity: 24 A

# ST 2,5-TWIN-TG/1P - Disconnect terminal block

3040847

<https://www.phoenixcontact.com/in/products/3040847>

## FBS 50-5 - Plug-in bridge

3038930

<https://www.phoenixcontact.com/in/products/3038930>



Plug-in bridge, pitch: 5.2 mm, number of positions: 50, color: red

 Max. current carrying capacity: 24 A

---

## FBS 2-5 BU - Plug-in bridge

3036877

<https://www.phoenixcontact.com/in/products/3036877>



Plug-in bridge, pitch: 5.2 mm, number of positions: 2, color: blue

 Max. current carrying capacity: 24 A

# ST 2,5-TWIN-TG/1P - Disconnect terminal block

3040847

<https://www.phoenixcontact.com/in/products/3040847>

## FBS 3-5 BU - Plug-in bridge

3036880

<https://www.phoenixcontact.com/in/products/3036880>



Plug-in bridge, pitch: 5.2 mm, number of positions: 3, color: blue

 Max. current carrying capacity: 24 A

---

## FBS 4-5 BU - Plug-in bridge

3036893

<https://www.phoenixcontact.com/in/products/3036893>



Plug-in bridge, pitch: 5.2 mm, number of positions: 4, color: blue

 Max. current carrying capacity: 24 A

# ST 2,5-TWIN-TG/1P - Disconnect terminal block

3040847

<https://www.phoenixcontact.com/in/products/3040847>

## FBS 5-5 BU - Plug-in bridge

3036903

<https://www.phoenixcontact.com/in/products/3036903>



Plug-in bridge, pitch: 5.2 mm, number of positions: 5, color: blue

 Max. current carrying capacity: 24 A

---

## FBS 10-5 BU - Plug-in bridge

3036916

<https://www.phoenixcontact.com/in/products/3036916>



Plug-in bridge, pitch: 5.2 mm, number of positions: 10, color: blue

 Max. current carrying capacity: 24 A



# ST 2,5-TWIN-TG/1P - Disconnect terminal block

3040847

<https://www.phoenixcontact.com/in/products/3040847>

## FBS 20-5 BU - Plug-in bridge

3036929

<https://www.phoenixcontact.com/in/products/3036929>



Plug-in bridge, pitch: 5.2 mm, number of positions: 20, color: blue

 Max. current carrying capacity: 24 A

---

## FBS 50-5 BU - Plug-in bridge

3032114

<https://www.phoenixcontact.com/in/products/3032114>



Plug-in bridge, pitch: 5.2 mm, number of positions: 50, color: blue

 Max. current carrying capacity: 24 A

# ST 2,5-TWIN-TG/1P - Disconnect terminal block

3040847

<https://www.phoenixcontact.com/in/products/3040847>

## FBS 2-5 GY - Plug-in bridge

3038969

<https://www.phoenixcontact.com/in/products/3038969>



Plug-in bridge, pitch: 5.2 mm, number of positions: 2, color: gray

 Max. current carrying capacity: 24 A

---

## FBS 3-5 GY - Plug-in bridge

3038972

<https://www.phoenixcontact.com/in/products/3038972>



Plug-in bridge, pitch: 5.2 mm, number of positions: 3, color: gray

 Max. current carrying capacity: 24 A

# ST 2,5-TWIN-TG/1P - Disconnect terminal block

3040847

<https://www.phoenixcontact.com/in/products/3040847>

## FBS 4-5 GY - Plug-in bridge

3038985

<https://www.phoenixcontact.com/in/products/3038985>



Plug-in bridge, pitch: 5.2 mm, number of positions: 4, color: gray

 Max. current carrying capacity: 24 A

---

## FBS 5-5 GY - Plug-in bridge

3038998

<https://www.phoenixcontact.com/in/products/3038998>



Plug-in bridge, pitch: 5.2 mm, number of positions: 5, color: gray

 Max. current carrying capacity: 24 A

# ST 2,5-TWIN-TG/1P - Disconnect terminal block

3040847

<https://www.phoenixcontact.com/in/products/3040847>

## FBS 10-5 GY - Plug-in bridge

3039007

<https://www.phoenixcontact.com/in/products/3039007>



Plug-in bridge, pitch: 5.2 mm, number of positions: 10, color: gray

 Max. current carrying capacity: 24 A

---

## FBS 20-5 GY - Plug-in bridge

3038671

<https://www.phoenixcontact.com/in/products/3038671>



Plug-in bridge, pitch: 5.2 mm, number of positions: 20, color: gray

 Max. current carrying capacity: 24 A

# ST 2,5-TWIN-TG/1P - Disconnect terminal block

3040847

<https://www.phoenixcontact.com/in/products/3040847>

## FBS 50-5 GY - Plug-in bridge

3032127

<https://www.phoenixcontact.com/in/products/3032127>



Plug-in bridge, pitch: 5.2 mm, number of positions: 50, color: gray

 Max. current carrying capacity: 24 A

---

## FBSR 2-5 - Plug-in bridge

3033702

<https://www.phoenixcontact.com/in/products/3033702>



Plug-in bridge, pitch: 5.2 mm, number of positions: 2, color: red

 Max. current carrying capacity: 17.5 A

# ST 2,5-TWIN-TG/1P - Disconnect terminal block

3040847

<https://www.phoenixcontact.com/in/products/3040847>

## FBSR 3-5 - Plug-in bridge

3001591

<https://www.phoenixcontact.com/in/products/3001591>



Plug-in bridge, pitch: 5.2 mm, number of positions: 3, color: red

 Max. current carrying capacity: 17.5 A

---

## FBSR 4-5 - Plug-in bridge

3001592

<https://www.phoenixcontact.com/in/products/3001592>



Plug-in bridge, pitch: 5.2 mm, number of positions: 4, color: red

 Max. current carrying capacity: 17.5 A

---

# ST 2,5-TWIN-TG/1P - Disconnect terminal block

3040847

<https://www.phoenixcontact.com/in/products/3040847>

## FBSR 5-5 - Plug-in bridge

3001593

<https://www.phoenixcontact.com/in/products/3001593>



Plug-in bridge, pitch: 5.2 mm, number of positions: 5, color: red

 Max. current carrying capacity: 17.5 A

---

## FBSR 10-5 - Plug-in bridge

3033710

<https://www.phoenixcontact.com/in/products/3033710>



Plug-in bridge, pitch: 5.2 mm, number of positions: 10, color: red

 Max. current carrying capacity: 17.5 A

# ST 2,5-TWIN-TG/1P - Disconnect terminal block

3040847

<https://www.phoenixcontact.com/in/products/3040847>

## RB ST (2,5/4)-1,5/S - Reducing bridge

3214356

<https://www.phoenixcontact.com/in/products/3214356>



Reducing bridge, pitch: 6.7 mm, number of positions: 2, length: 23 mm, color: red

 Max. current carrying capacity: 24 A

---

## RB ST 6-(2,5/4) - Reducing bridge

3030860

<https://www.phoenixcontact.com/in/products/3030860>



Reducing bridge, pitch: 9 mm, number of positions: 2, length: 30 mm, color: red

 Max. current carrying capacity: 35 A



# ST 2,5-TWIN-TG/1P - Disconnect terminal block

3040847

<https://www.phoenixcontact.com/in/products/3040847>

## RB ST 10-(2,5/4) - Reducing bridge

3030873

<https://www.phoenixcontact.com/in/products/3030873>



Reducing bridge, pitch: 10 mm, number of positions: 2, length: 36 mm, color: red

 Max. current carrying capacity: 35 A

---

## RB ST 16-(2,5/4) - Reducing bridge

3030886

<https://www.phoenixcontact.com/in/products/3030886>



Reducing bridge, pitch: 11 mm, number of positions: 2, length: 37 mm, color: red

 Max. current carrying capacity: 35 A

---

# ST 2,5-TWIN-TG/1P - Disconnect terminal block

3040847

<https://www.phoenixcontact.com/in/products/3040847>

## RB ST 35-(2,5/4) - Reducing bridge

3030899

<https://www.phoenixcontact.com/in/products/3030899>



Reducing bridge, pitch: 11 mm, number of positions: 2, color: red

 Max. current carrying capacity: 35 A

---

## RB ST (2,5/4)-1,5 - Reducing bridge

3038943

<https://www.phoenixcontact.com/in/products/3038943>



Reducing bridge, pitch: 7.1 mm, number of positions: 2, length: 23 mm, color: red

 Max. current carrying capacity: 24 A

# ST 2,5-TWIN-TG/1P - Disconnect terminal block

3040847

<https://www.phoenixcontact.com/in/products/3040847>

## RB UT 6-ST(2,5/4) - Reducing bridge

3047264

<https://www.phoenixcontact.com/in/products/3047264>



Reducing bridge, pitch: 9.5 mm, number of positions: 2, length: 33 mm, color: red

 Max. current carrying capacity: 35 A

---

## RB UT 35-ST(2,5/4) - Reducing bridge

3047280

<https://www.phoenixcontact.com/in/products/3047280>



Reducing bridge, pitch: 10.8 mm, number of positions: 2, color: red

 Max. current carrying capacity: 40 A

---

# ST 2,5-TWIN-TG/1P - Disconnect terminal block

3040847

<https://www.phoenixcontact.com/in/products/3040847>

## RB UT 10-ST(2,5/4) - Reducing bridge

3047086

<https://www.phoenixcontact.com/in/products/3047086>



Reducing bridge, pitch: 10.2 mm, number of positions: 2, length: 33 mm, color: red

 Max. current carrying capacity: 40 A

---

## RB UT 16-ST(2,5/4) - Reducing bridge

3047099

<https://www.phoenixcontact.com/in/products/3047099>



Reducing bridge, pitch: 11 mm, number of positions: 2, length: 41 mm, color: red

 Max. current carrying capacity: 40 A

# ST 2,5-TWIN-TG/1P - Disconnect terminal block



3040847

<https://www.phoenixcontact.com/in/products/3040847>

## D-ST 2,5-QUATTRO/2P - End cover

3040083

<https://www.phoenixcontact.com/in/products/3040083>

End cover, length: 81 mm, width: 2.2 mm, height: 36.5 mm, color: gray



---

## ATP-ST QUATTRO - Partition plate

3030815

<https://www.phoenixcontact.com/in/products/3030815>

Partition plate, length: 90.9 mm, width: 2 mm, height: 45 mm, color: gray



# ST 2,5-TWIN-TG/1P - Disconnect terminal block

3040847

<https://www.phoenixcontact.com/in/products/3040847>

## PC - Coding star

3040588

<https://www.phoenixcontact.com/in/products/3040588>

Coding star, length: 3 mm, width: 3 mm, height: 6 mm, color: red



---

## SZF 1-0,6X3,5 - Screwdriver

1204517

<https://www.phoenixcontact.com/in/products/1204517>

Actuation tool, for ST terminal blocks, also suitable for use as a bladed screwdriver, size: 0.6 x 3.5 x 100 mm, 2-component grip, with non-slip grip



# ST 2,5-TWIN-TG/1P - Disconnect terminal block

3040847

<https://www.phoenixcontact.com/in/products/3040847>

## ST-IL - Mounting material

3039900

<https://www.phoenixcontact.com/in/products/3039900>

Operating decal for the ST terminal block



---

## ST-BW - Actuation tool

1207608

<https://www.phoenixcontact.com/in/products/1207608>

Actuation tool, for all 2.5 mm<sup>2</sup> - 4.0 mm<sup>2</sup> spring-cages



# ST 2,5-TWIN-TG/1P - Disconnect terminal block

3040847

<https://www.phoenixcontact.com/in/products/3040847>

## CEC 2,5 - Filler plugs

3062757

<https://www.phoenixcontact.com/in/products/3062757>

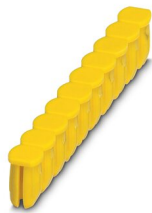

Cover for conductor shaft, 10-pos., for spring cage terminal blocks (ST) and terminal blocks with push-in technology (PT) with a width of 5.2 mm

---

## P-CO 2-5 R47K - Component connector

3032447

<https://www.phoenixcontact.com/in/products/3032447>



Component connector, with 47 kOhm resistance for wire-break monitoring, pitch: 5.2 mm, length: 8.9 mm, width: 4.1 mm, height: 34.8 mm, number of positions: 2, color: black



# ST 2,5-TWIN-TG/1P - Disconnect terminal block

3040847

<https://www.phoenixcontact.com/in/products/3040847>

## P-DI - Isolating plugs

3036783

<https://www.phoenixcontact.com/in/products/3036783>



Isolating plugs, length: 10.8 mm, width: 3.5 mm, height: 23.1 mm, color: orange

---

## P-DI GY - Isolating plugs

3047390

<https://www.phoenixcontact.com/in/products/3047390>



Isolating plugs, length: 10.8 mm, width: 3.5 mm, height: 23.1 mm, color: gray

# ST 2,5-TWIN-TG/1P - Disconnect terminal block

3040847

<https://www.phoenixcontact.com/in/products/3040847>

## P-DI GN - Isolating plugs

1071062

<https://www.phoenixcontact.com/in/products/1071062>

Isolating plugs, length: 10.8 mm, width: 3.5 mm, height: 23.1 mm, color: green



---

## WST 2,5 - Warning cover

3030941

<https://www.phoenixcontact.com/in/products/3030941>

Warning cover, 5-pos., for terminal width: 5.2 mm



## ST 2,5-TWIN-TG/1P - Disconnect terminal block

3040847

<https://www.phoenixcontact.com/in/products/3040847>



## BST 2,5 - Group cover marker

3061282

<https://www.phoenixcontact.com/in/products/3061282>



Cover for actuation shaft, 5-pos., for spring-cage terminal blocks with width of 5.2 mm

---

## NS 35/ 7,5 PERF 2000MM - DIN rail perforated

0801733

<https://www.phoenixcontact.com/in/products/0801733>



DIN rail perforated, acc. to EN 60715, material: Steel, galvanized, passivated with a thick layer, Standard profile, color: silver, Pack of 25 (50 m)

# ST 2,5-TWIN-TG/1P - Disconnect terminal block

3040847

<https://www.phoenixcontact.com/in/products/3040847>

## NS 35/ 7,5 UNPERF 2000MM - DIN rail, unperforated

0801681

<https://www.phoenixcontact.com/in/products/0801681>



DIN rail, unperforated, acc. to EN 60715, material: Steel, galvanized, passivated with a thick layer, Standard profile, color: silver, Pack of 25 (50 m)

---

## NS 35/ 7,5 WH PERF 2000MM - DIN rail perforated

1204119

<https://www.phoenixcontact.com/in/products/1204119>



DIN rail perforated, acc. to EN 60715, material: Steel, Galvanized, white passivated, Standard profile, color: silver, Pack of 25 (50 m)

# ST 2,5-TWIN-TG/1P - Disconnect terminal block

3040847

<https://www.phoenixcontact.com/in/products/3040847>

## NS 35/ 7,5 WH UNPERF 2000MM-VPE 10 - DIN rail, unperforated

1204122

<https://www.phoenixcontact.com/in/products/1204122>



DIN rail, unperforated, acc. to EN 60715, material: Steel, Galvanized, white passivated, Standard profile, color: silver, Pack of 10 (20 m)

---

## NS 35/ 7,5 AL UNPERF 2000MM - DIN rail, unperforated

0801704

<https://www.phoenixcontact.com/in/products/0801704>



DIN rail, unperforated, acc. to EN 60715, material: Aluminum, uncoated, Standard profile, color: silver, Pack of 25 (50 m)

# ST 2,5-TWIN-TG/1P - Disconnect terminal block

3040847

<https://www.phoenixcontact.com/in/products/3040847>

## NS 35/ 7,5 ZN PERF 2000MM - DIN rail perforated

1206421

<https://www.phoenixcontact.com/in/products/1206421>



DIN rail perforated, acc. to EN 60715, material: Steel, galvanized, Standard profile, color: silver, Pack of 25 (50 m)

---

## NS 35/ 7,5 ZN UNPERF 2000MM - DIN rail, unperforated

1206434

<https://www.phoenixcontact.com/in/products/1206434>



DIN rail, unperforated, acc. to EN 60715, material: Steel, galvanized, Standard profile, color: silver, Pack of 25 (50 m)

# ST 2,5-TWIN-TG/1P - Disconnect terminal block

3040847

<https://www.phoenixcontact.com/in/products/3040847>



## NS 35/ 7,5 CU UNPERF 2000MM-VPE 10 - DIN rail, unperforated

0801762

<https://www.phoenixcontact.com/in/products/0801762>



DIN rail, unperforated, acc. to EN 60715, material: Copper, uncoated, Standard profile, color: copper-colored, Pack of 10 (20 m)

---

## NS 35/ 7,5 CAP - End cap

1206560

<https://www.phoenixcontact.com/in/products/1206560>

DIN rail end piece, for DIN rail NS 35/7.5



# ST 2,5-TWIN-TG/1P - Disconnect terminal block

3040847

<https://www.phoenixcontact.com/in/products/3040847>

## ZB 5 :UNBEDRUCKT - Zack marker strip

1050004

<https://www.phoenixcontact.com/in/products/1050004>

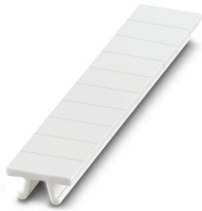

Zack marker strip, Strip, white, unlabeled, can be labeled with: PLOTMARK, CMS-P1-PLOTTER, mounting type: snapped, for terminal block width: 5.2 mm, lettering field size: 5.1 x 10.5 mm, Number of individual labels: 10

---

## ZB 5 CUS - Zack marker strip

0824962

<https://www.phoenixcontact.com/in/products/0824962>



Zack marker strip, can be ordered: Strip, white, labeled according to customer specifications, mounting type: snap into tall marker groove, for terminal block width: 5.2 mm, lettering field size: 5.15 x 10.5 mm, Number of individual labels: 10



# ST 2,5-TWIN-TG/1P - Disconnect terminal block



3040847

<https://www.phoenixcontact.com/in/products/3040847>

## ZB 5,LGS:FORTL.ZAHLEN - Zack marker strip

1050017

<https://www.phoenixcontact.com/in/products/1050017>



Zack marker strip, Strip, white, labeled, printed horizontally: consecutive numbers 1 ... 10, 11 ... 20, etc. up to 491 ... 500, mounting type: snapped, for terminal block width: 5.2 mm, lettering field size: 5.15 x 10.5 mm, Number of individual labels: 10

---

## ZB 5,QR:FORTL.ZAHLEN - Zack marker strip

1050020

<https://www.phoenixcontact.com/in/products/1050020>

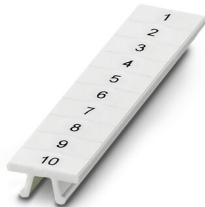

Zack marker strip, white, Printed vertically: consecutive numbers 1 ... 10, 11 ... 20, etc. up to 491 ... 500, mounting type: snapped, for terminal block width: 5.2 mm, lettering field size: 5.15 x 10.5 mm

# ST 2,5-TWIN-TG/1P - Disconnect terminal block

3040847

<https://www.phoenixcontact.com/in/products/3040847>

## ZB 5,LGS:GLEICHE ZAHLEN - Zack marker strip

1050033

<https://www.phoenixcontact.com/in/products/1050033>



Zack marker strip, Strip, white, labeled, can be labeled with: CMS-P1-PLOTTER, printed horizontally: Identical numbers 1 or 2, etc. up to 100, mounting type: snapped, for terminal block width: 5.2 mm, lettering field size: 5.15 x 10.5 mm, Number of individual labels: 10

---

## ZB 5,LGS:L1-N,PE - Zack marker strip

1050415

<https://www.phoenixcontact.com/in/products/1050415>



Zack marker strip, Strip, white, labeled, horizontal: L1, L2, L3, N, PE, L1, L2, L3, N, PE, mounting type: snapped, for terminal block width: 5.2 mm, lettering field size: 5.15 x 10.5 mm, Number of individual labels: 10

# ST 2,5-TWIN-TG/1P - Disconnect terminal block



3040847

<https://www.phoenixcontact.com/in/products/3040847>

## UC-TM 5 - Marker for terminal blocks

0818108

<https://www.phoenixcontact.com/in/products/0818108>



Marker for terminal blocks, Sheet, white, unlabeled, can be labeled with: BLUEMARK ID COLOR, BLUEMARK ID, BLUEMARK CLED, PLOTMARK, CMS-P1-PLOTTER, mounting type: snapped, for terminal block width: 5.2 mm, lettering field size: 4.6 x 10.5 mm, Number of individual labels: 96

---

## UC-TM 5 CUS - Marker for terminal blocks

0824581

<https://www.phoenixcontact.com/in/products/0824581>



Marker for terminal blocks, can be ordered: by sheet, white, labeled according to customer specifications, mounting type: snap into tall marker groove, for terminal block width: 5.2 mm, lettering field size: 10.5 x 4.6 mm, Number of individual labels: 96

# ST 2,5-TWIN-TG/1P - Disconnect terminal block



3040847

<https://www.phoenixcontact.com/in/products/3040847>

## UCT-TM 5 - Marker for terminal blocks

0828734

<https://www.phoenixcontact.com/in/products/0828734>



Marker for terminal blocks, Sheet, white, unlabeled, can be labeled with: TOPMARK NEO, TOPMARK LASER, BLUEMARK ID COLOR, BLUEMARK ID, BLUEMARK CLED, THERMOMARK PRIME, THERMOMARK CARD 2.0, THERMOMARK CARD, mounting type: snapped, for terminal block width: 5.2 mm, lettering field size: 4.6 x 10.5 mm, Number of individual labels: 72

---

## UCT-TM 5 CUS - Marker for terminal blocks

0829595

<https://www.phoenixcontact.com/in/products/0829595>



Marker for terminal blocks, can be ordered: by sheet, white, labeled according to customer specifications, mounting type: snap into tall marker groove, for terminal block width: 5.2 mm, lettering field size: 4.6 x 10.5 mm, Number of individual labels: 72

# ST 2,5-TWIN-TG/1P - Disconnect terminal block

3040847

<https://www.phoenixcontact.com/in/products/3040847>

## GBS 5-25X12 - Group marker label for terminal marking

0810588

<https://www.phoenixcontact.com/in/products/0810588>



Group marker label, snaps onto terminal center for screw, spring-cage and quick connection terminal blocks, labeled with a 25 x 12 mm label or manually with the B-STIFT, in the foot part with ZB 5

---

## GBS 5-25X5 - Group marker label for terminal marking

0829126

<https://www.phoenixcontact.com/in/products/0829126>



Group marking label, can be snapped into terminal center for screw, spring-cage, push-in, and fast connection terminal blocks, can be labeled with a 24 x 4 mm label or manually using B-STIFT, in the foot part with ZB 5

# ST 2,5-TWIN-TG/1P - Disconnect terminal block

3040847

<https://www.phoenixcontact.com/in/products/3040847>

## STP 5-2-ZB - Marker carriers

3037643

<https://www.phoenixcontact.com/in/products/3037643>



Marker carriers, snaps into ST 2,5 spring-cage terminal blocks, can be marked with UC-TM 5, UC-TMF 5, UCT-TM 5, UCT-TMF 5, ZB 5, or ZBF 5, gray, unlabeled, mounting type: plug in

---

## ZBF 5:UNBEDRUCKT - Zack Marker strip, flat

0808642

<https://www.phoenixcontact.com/in/products/0808642>



Zack Marker strip, flat, Strip, white, unlabeled, can be labeled with: PLOTMARK, CMS-P1-PLOTTER, mounting type: snapped, for terminal block width: 5 mm, lettering field size: 5.1 x 5.2 mm, Number of individual labels: 10

# ST 2,5-TWIN-TG/1P - Disconnect terminal block

3040847

<https://www.phoenixcontact.com/in/products/3040847>

## ZBF 5 CUS - Zack Marker strip, flat

0825025

<https://www.phoenixcontact.com/in/products/0825025>



Zack Marker strip, flat, can be ordered: Strip, white, labeled according to customer specifications, mounting type: snap into flat marker groove, for terminal block width: 5 mm, lettering field size: 5.15 x 5.15 mm, Number of individual labels: 10

---

## ZBF 5,LGS:FORTL.ZAHLEN - Zack Marker strip, flat

0808671

<https://www.phoenixcontact.com/in/products/0808671>



Zack Marker strip, flat, Strip, white, labeled, printed horizontally: consecutive numbers 1 ... 10, 11 ... 20, etc. up to 491 ... 500, mounting type: snapped, for terminal block width: 5 mm, lettering field size: 5.15 x 5.15 mm, Number of individual labels: 10

# ST 2,5-TWIN-TG/1P - Disconnect terminal block



3040847

<https://www.phoenixcontact.com/in/products/3040847>

## ZBF 5,QR:FORTL.ZAHLEN - Zack Marker strip, flat

0808697

<https://www.phoenixcontact.com/in/products/0808697>

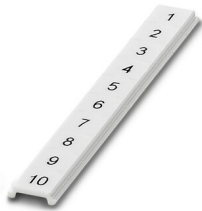

Zack Marker strip, flat, Strip, white, labeled, Printed vertically: consecutive numbers 1 ... 10, 11 ... 20, etc. up to 91 ... 100, mounting type: snapped, for terminal block width: 5 mm, lettering field size: 5.15 x 5.15 mm, Number of individual labels: 10

---

## ZBF 5,LGS:GERADE ZAHLEN - Zack Marker strip, flat

0810821

<https://www.phoenixcontact.com/in/products/0810821>



Zack Marker strip, flat, Strip, white, labeled, printed horizontally: consecutive even numbers 2 ... 20, 22 ... 40, etc. up to 82 ... 100, mounting type: snapped, for terminal block width: 5 mm, lettering field size: 5.15 x 5.15 mm, Number of individual labels: 10



# ST 2,5-TWIN-TG/1P - Disconnect terminal block



3040847

<https://www.phoenixcontact.com/in/products/3040847>

## ZBF 5,LGS:UNGERADE ZAHLEN - Zack Marker strip, flat

0810863

<https://www.phoenixcontact.com/in/products/0810863>



Zack Marker strip, flat, Strip, white, labeled, printed horizontally: Odd numbers 1 - 19, 21 - 39, etc. up to 81 - 99, mounting type: snapped, for terminal block width: 5 mm, lettering field size: 5.15 x 5.15 mm, Number of individual labels: 10

---

## UC-TMF 5 - Marker for terminal blocks

0818153

<https://www.phoenixcontact.com/in/products/0818153>



Marker for terminal blocks, Sheet, white, unlabeled, can be labeled with: BLUEMARK ID COLOR, BLUEMARK ID, BLUEMARK CLED, PLOTMARK, CMS-P1-PLOTTER, mounting type: snapped, for terminal block width: 5.2 mm, lettering field size: 4.6 x 5.1 mm, Number of individual labels: 96

# ST 2,5-TWIN-TG/1P - Disconnect terminal block



3040847

<https://www.phoenixcontact.com/in/products/3040847>

## UC-TMF 5 CUS - Marker for terminal blocks

0824638

<https://www.phoenixcontact.com/in/products/0824638>



Marker for terminal blocks, can be ordered: by sheet, white, labeled according to customer specifications, mounting type: snap into flat marker groove, for terminal block width: 5.2 mm, lettering field size: 4.6 x 5.1 mm, Number of individual labels: 96

---

## UCT-TMF 5 - Marker for terminal blocks

0828744

<https://www.phoenixcontact.com/in/products/0828744>



Marker for terminal blocks, Sheet, white, unlabeled, can be labeled with: TOPMARK NEO, TOPMARK LASER, BLUEMARK ID COLOR, BLUEMARK ID, BLUEMARK CLED, THERMOMARK PRIME, THERMOMARK CARD 2.0, THERMOMARK CARD, mounting type: snapped, for terminal block width: 5.2 mm, lettering field size: 4.4 x 4.7 mm, Number of individual labels: 72

## ST 2,5-TWIN-TG/1P - Disconnect terminal block

3040847

<https://www.phoenixcontact.com/in/products/3040847>



## UCT-TMF 5 CUS - Marker for terminal blocks

0829658

<https://www.phoenixcontact.com/in/products/0829658>



Marker for terminal blocks, can be ordered: by sheet, white, labeled according to customer specifications, mounting type: snap into flat marker groove, for terminal block width: 5.2 mm, lettering field size: 4.4 x 4.7 mm, Number of individual labels: 72

---

## ISH 2,5/0,2 - Insulating sleeve

3002843

<https://www.phoenixcontact.com/in/products/3002843>



Insulating sleeve, color: white

# ST 2,5-TWIN-TG/1P - Disconnect terminal block



3040847

<https://www.phoenixcontact.com/in/products/3040847>

## ISH 2,5/0,5 - Insulating sleeve

3002856

<https://www.phoenixcontact.com/in/products/3002856>



Insulating sleeve, color: gray

---

## ISH 2,5/1,0 - Insulating sleeve

3002869

<https://www.phoenixcontact.com/in/products/3002869>



Insulating sleeve, color: black

# ST 2,5-TWIN-TG/1P - Disconnect terminal block



3040847

<https://www.phoenixcontact.com/in/products/3040847>

## PAI-4-FIX-5/6 BU - Test adapter

3035975

<https://www.phoenixcontact.com/in/products/3035975>



4 mm test adapter, for terminal blocks with 5.2 mm and 6.2 mm pitch

---

## PAI-4-FIX-5/6 OG - Test adapter

3035974

<https://www.phoenixcontact.com/in/products/3035974>



4 mm test adapter, for terminal blocks with 5.2 mm and 6.2 mm pitch

# ST 2,5-TWIN-TG/1P - Disconnect terminal block

3040847

<https://www.phoenixcontact.com/in/products/3040847>

## PAI-4-FIX-5/6 YE - Test adapter

3035977

<https://www.phoenixcontact.com/in/products/3035977>



4 mm test adapter, for terminal blocks with 5.2 mm and 6.2 mm pitch

---

## PAI-4-FIX-5/6 RD - Test adapter

3035976

<https://www.phoenixcontact.com/in/products/3035976>



4 mm test adapter, for terminal blocks with 5.2 mm and 6.2 mm pitch

# ST 2,5-TWIN-TG/1P - Disconnect terminal block



3040847

<https://www.phoenixcontact.com/in/products/3040847>

## PAI-4-FIX-5/6 GN - Test adapter

3035978

<https://www.phoenixcontact.com/in/products/3035978>



4 mm test adapter, for terminal blocks with 5.2 mm and 6.2 mm pitch

---

## PAI-4-FIX-5/6 BK - Test adapter

3035980

<https://www.phoenixcontact.com/in/products/3035980>



4 mm test adapter, for terminal blocks with 5.2 mm and 6.2 mm pitch

# ST 2,5-TWIN-TG/1P - Disconnect terminal block



3040847

<https://www.phoenixcontact.com/in/products/3040847>

## PAI-4-FIX-5/6 GY - Test adapter

3035982

<https://www.phoenixcontact.com/in/products/3035982>



4 mm test adapter, for terminal blocks with 5.2 mm and 6.2 mm pitch

---

## PAI-4-FIX-5/6 VT - Test adapter

3035979

<https://www.phoenixcontact.com/in/products/3035979>



4 mm test adapter, for terminal blocks with 5.2 mm and 6.2 mm pitch



# ST 2,5-TWIN-TG/1P - Disconnect terminal block



3040847

<https://www.phoenixcontact.com/in/products/3040847>

## PAI-4-FIX-5/6 BN - Test adapter

3035981

<https://www.phoenixcontact.com/in/products/3035981>



4 mm test adapter, for terminal blocks with 5.2 mm and 6.2 mm pitch

---

## PAI-4-FIX-5/6 WH - Test adapter

3035983

<https://www.phoenixcontact.com/in/products/3035983>



4 mm test adapter, for terminal blocks with 5.2 mm and 6.2 mm pitch

# ST 2,5-TWIN-TG/1P - Disconnect terminal block

3040847

<https://www.phoenixcontact.com/in/products/3040847>

## PS-5 - Test plugs

3030983

<https://www.phoenixcontact.com/in/products/3030983>



Test plugs, Modular test plug, number of positions: 1, fuse type: , mounting type: , , color: red

---

## DP PS-5 - Spacer plate

3036725

<https://www.phoenixcontact.com/in/products/3036725>



Spacer plate, length: 22.4 mm, width: 5.2 mm, height: 29 mm, number of positions: 1, color: red

# ST 2,5-TWIN-TG/1P - Disconnect terminal block



3040847

<https://www.phoenixcontact.com/in/products/3040847>

## PS-5/2,3MM RD - Test plugs

3038723

<https://www.phoenixcontact.com/in/products/3038723>

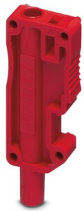

Test plugs, number of positions: 1, fuse type: , mounting type: , , color: red

---

## P-FIX - Feed-through connector

3038956

<https://www.phoenixcontact.com/in/products/3038956>



Feed-through connector, length: 10.5 mm, width: 4 mm, color: gray

# ST 2,5-TWIN-TG/1P - Disconnect terminal block

3040847

<https://www.phoenixcontact.com/in/products/3040847>

## P-CO - Component connector

3036796

<https://www.phoenixcontact.com/in/products/3036796>



Component connector, for installing components that can be individually selected, nominal current: 6 A, pitch: 5.2 mm, length: 24.2 mm, width: 5.1 mm, height: 33.2 mm, number of positions: 1, color: gray

---

## P-CO 1N4007/R-L - Component connector

3032457

<https://www.phoenixcontact.com/in/products/3032457>



Component connector, with diode 1N4007, length: 24.2 mm, width: 5.2 mm, height: 33.3 mm, number of positions: 1, color: gray

# ST 2,5-TWIN-TG/1P - Disconnect terminal block

3040847

<https://www.phoenixcontact.com/in/products/3040847>

## P-CO 1N4007/L-R - Component connector

3032460

<https://www.phoenixcontact.com/in/products/3032460>



Component connector, with diode 1N4007, length: 24.2 mm, width: 5.2 mm, height: 33.3 mm, number of positions: 1, color: gray

---

## P-CO XL - Component connector

3036797

<https://www.phoenixcontact.com/in/products/3036797>



Component connector, for installing components that can be individually selected up to a diameter of 10 mm and power dissipation of up to 1 W, nominal current: 10 A, length: 41.2 mm, width: 12.3 mm, height: 37.5 mm, number of positions: 1, color: gray

# ST 2,5-TWIN-TG/1P - Disconnect terminal block

3040847

<https://www.phoenixcontact.com/in/products/3040847>

## P-CO XL SKN - Component connector

3036798

<https://www.phoenixcontact.com/in/products/3036798>



Component connector, specifically for holding the SKN 2,5 diode, nominal current: 10 A, length: 41.2 mm, width: 12.3 mm, height: 37.5 mm, number of positions: 1, color: gray

---

## E/AL-NS 35 - End clamp

1201662

<https://www.phoenixcontact.com/in/products/1201662>



End clamp, for end support of UKH 50 to UKH 240, is pushed onto DIN rail NS 35 and fixed with 2 screws, width: 10 mm, color: aluminum

# ST 2,5-TWIN-TG/1P - Disconnect terminal block

3040847

<https://www.phoenixcontact.com/in/products/3040847>

## SP 2,5/ 1 - Plug

3040258

<https://www.phoenixcontact.com/in/products/3040258>



Plug, nom. voltage: 500 V, nominal current: 24 A, number of positions: 1, connection method: Spring-cage connection, Rated cross section: 2.5 mm<sup>2</sup>, cross section: 0.08 mm<sup>2</sup>- 4 mm<sup>2</sup>, color: gray

---

## SP 2,5/ 2 - Plug

3040261

<https://www.phoenixcontact.com/in/products/3040261>



Plug, nom. voltage: 500 V, nominal current: 24 A, number of positions: 2, connection method: Spring-cage connection, Rated cross section: 2.5 mm<sup>2</sup>, cross section: 0.08 mm<sup>2</sup>- 4 mm<sup>2</sup>, color: gray

# ST 2,5-TWIN-TG/1P - Disconnect terminal block

3040847

<https://www.phoenixcontact.com/in/products/3040847>

## SP 2,5/ 3 - Plug

3040274

<https://www.phoenixcontact.com/in/products/3040274>



Plug, nom. voltage: 500 V, nominal current: 24 A, number of positions: 3, connection method: Spring-cage connection, Rated cross section: 2.5 mm<sup>2</sup>, cross section: 0.08 mm<sup>2</sup>- 4 mm<sup>2</sup>, color: gray

---

## SP 2,5/ 4 - Plug

3040287

<https://www.phoenixcontact.com/in/products/3040287>



Plug, nom. voltage: 500 V, nominal current: 24 A, number of positions: 4, connection method: Spring-cage connection, Rated cross section: 2.5 mm<sup>2</sup>, cross section: 0.08 mm<sup>2</sup>- 4 mm<sup>2</sup>, color: gray



# ST 2,5-TWIN-TG/1P - Disconnect terminal block

3040847

<https://www.phoenixcontact.com/in/products/3040847>

## SP 2,5/ 5 - Plug

3040290

<https://www.phoenixcontact.com/in/products/3040290>



Plug, nom. voltage: 500 V, nominal current: 24 A, number of positions: 5, connection method: Spring-cage connection, Rated cross section: 2.5 mm<sup>2</sup>, cross section: 0.08 mm<sup>2</sup>- 4 mm<sup>2</sup>, color: gray

---

## SP 2,5/ 6 - Plug

3040300

<https://www.phoenixcontact.com/in/products/3040300>



Plug, nom. voltage: 500 V, nominal current: 24 A, number of positions: 6, connection method: Spring-cage connection, Rated cross section: 2.5 mm<sup>2</sup>, cross section: 0.08 mm<sup>2</sup>- 4 mm<sup>2</sup>, color: gray

# ST 2,5-TWIN-TG/1P - Disconnect terminal block

3040847

<https://www.phoenixcontact.com/in/products/3040847>

## SP 2,5/ 7 - Plug

3040313

<https://www.phoenixcontact.com/in/products/3040313>



Plug, nom. voltage: 500 V, nominal current: 24 A, number of positions: 7, connection method: Spring-cage connection, Rated cross section: 2.5 mm<sup>2</sup>, cross section: 0.08 mm<sup>2</sup>- 4 mm<sup>2</sup>, color: gray

---

## SP 2,5/ 8 - Plug

3040326

<https://www.phoenixcontact.com/in/products/3040326>



Plug, nom. voltage: 500 V, nominal current: 24 A, number of positions: 8, connection method: Spring-cage connection, Rated cross section: 2.5 mm<sup>2</sup>, cross section: 0.08 mm<sup>2</sup>- 4 mm<sup>2</sup>, color: gray

# ST 2,5-TWIN-TG/1P - Disconnect terminal block

3040847

<https://www.phoenixcontact.com/in/products/3040847>

## SP 2,5/ 9 - Plug

3040339

<https://www.phoenixcontact.com/in/products/3040339>



Plug, nom. voltage: 500 V, nominal current: 24 A, number of positions: 9, connection method: Spring-cage connection, Rated cross section: 2.5 mm<sup>2</sup>, cross section: 0.08 mm<sup>2</sup>- 4 mm<sup>2</sup>, color: gray

---

## SP 2,5/10 - Plug

3040342

<https://www.phoenixcontact.com/in/products/3040342>



Plug, nom. voltage: 500 V, nominal current: 24 A, number of positions: 10, connection method: Spring-cage connection, Rated cross section: 2.5 mm<sup>2</sup>, cross section: 0.08 mm<sup>2</sup>- 4 mm<sup>2</sup>, color: gray

# ST 2,5-TWIN-TG/1P - Disconnect terminal block

3040847

<https://www.phoenixcontact.com/in/products/3040847>

## SP 2,5/11 - Plug

3040355

<https://www.phoenixcontact.com/in/products/3040355>



Plug, nom. voltage: 500 V, nominal current: 24 A, number of positions: 11, connection method: Spring-cage connection, Rated cross section: 2.5 mm<sup>2</sup>, cross section: 0.08 mm<sup>2</sup>- 4 mm<sup>2</sup>, color: gray

---

## SP 2,5/12 - Plug

3040368

<https://www.phoenixcontact.com/in/products/3040368>



Plug, nom. voltage: 500 V, nominal current: 24 A, number of positions: 12, connection method: Spring-cage connection, Rated cross section: 2.5 mm<sup>2</sup>, cross section: 0.08 mm<sup>2</sup>- 4 mm<sup>2</sup>, color: gray

# ST 2,5-TWIN-TG/1P - Disconnect terminal block

3040847

<https://www.phoenixcontact.com/in/products/3040847>

## SP 2,5/13 - Plug

3040371

<https://www.phoenixcontact.com/in/products/3040371>



Plug, nom. voltage: 500 V, nominal current: 24 A, number of positions: 13, connection method: Spring-cage connection, Rated cross section: 2.5 mm<sup>2</sup>, cross section: 0.08 mm<sup>2</sup>- 4 mm<sup>2</sup>, color: gray

---

## SP 2,5/14 - Plug

3040384

<https://www.phoenixcontact.com/in/products/3040384>



Plug, nom. voltage: 500 V, nominal current: 24 A, number of positions: 14, connection method: Spring-cage connection, Rated cross section: 2.5 mm<sup>2</sup>, cross section: 0.08 mm<sup>2</sup>- 4 mm<sup>2</sup>, color: gray

# ST 2,5-TWIN-TG/1P - Disconnect terminal block

3040847

<https://www.phoenixcontact.com/in/products/3040847>

## SP 2,5/15 - Plug

3040397

<https://www.phoenixcontact.com/in/products/3040397>



Plug, nom. voltage: 500 V, nominal current: 24 A, number of positions: 15, connection method: Spring-cage connection, Rated cross section: 2.5 mm<sup>2</sup>, cross section: 0.08 mm<sup>2</sup>- 4 mm<sup>2</sup>, color: gray

---

## SP 2,5/ 1 BU - Plug

3040698

<https://www.phoenixcontact.com/in/products/3040698>



Plug, nom. voltage: 500 V, nominal current: 24 A, number of positions: 1, connection method: Spring-cage connection, Rated cross section: 2.5 mm<sup>2</sup>, cross section: 0.08 mm<sup>2</sup>- 4 mm<sup>2</sup>, color: blue

# ST 2,5-TWIN-TG/1P - Disconnect terminal block

3040847

<https://www.phoenixcontact.com/in/products/3040847>

## SP 2,5/ 1 GNYE - Plug

3040708

<https://www.phoenixcontact.com/in/products/3040708>



Plug, nom. voltage: 500 V, nominal current: 24 A, number of positions: 1, connection method: Spring-cage connection, Rated cross section: 2.5 mm<sup>2</sup>, cross section: 0.08 mm<sup>2</sup>- 4 mm<sup>2</sup>, color: green-yellow

---

## SPB 2,5/ 1 - Plug

3040106

<https://www.phoenixcontact.com/in/products/3040106>



Plug, nom. voltage: 500 V, nominal current: 24 A, number of positions: 1, connection method: Spring-cage connection, Rated cross section: 2.5 mm<sup>2</sup>, cross section: 0.08 mm<sup>2</sup>- 4 mm<sup>2</sup>, color: gray

# ST 2,5-TWIN-TG/1P - Disconnect terminal block

3040847

<https://www.phoenixcontact.com/in/products/3040847>

## SPB 2,5/ 2 - Plug

3040119

<https://www.phoenixcontact.com/in/products/3040119>



Plug, nom. voltage: 500 V, nominal current: 24 A, number of positions: 2, connection method: Spring-cage connection, Rated cross section: 2.5 mm<sup>2</sup>, cross section: 0.08 mm<sup>2</sup>- 4 mm<sup>2</sup>, color: gray

---

## SPB 2,5/ 3 - Plug

3040122

<https://www.phoenixcontact.com/in/products/3040122>



Plug, nom. voltage: 500 V, nominal current: 24 A, number of positions: 3, connection method: Spring-cage connection, Rated cross section: 2.5 mm<sup>2</sup>, cross section: 0.08 mm<sup>2</sup>- 4 mm<sup>2</sup>, color: gray



# ST 2,5-TWIN-TG/1P - Disconnect terminal block

3040847

<https://www.phoenixcontact.com/in/products/3040847>

## SPB 2,5/ 4 - Plug

3040135

<https://www.phoenixcontact.com/in/products/3040135>



Plug, nom. voltage: 500 V, nominal current: 24 A, number of positions: 4, connection method: Spring-cage connection, Rated cross section: 2.5 mm<sup>2</sup>, cross section: 0.08 mm<sup>2</sup>- 4 mm<sup>2</sup>, color: gray

---

## SPB 2,5/ 5 - Plug

3040143

<https://www.phoenixcontact.com/in/products/3040143>



Plug, nom. voltage: 500 V, nominal current: 24 A, number of positions: 5, connection method: Spring-cage connection, Rated cross section: 2.5 mm<sup>2</sup>, cross section: 0.08 mm<sup>2</sup>- 4 mm<sup>2</sup>, color: gray

# ST 2,5-TWIN-TG/1P - Disconnect terminal block

3040847

<https://www.phoenixcontact.com/in/products/3040847>

## SPB 2,5/ 6 - Plug

3040151

<https://www.phoenixcontact.com/in/products/3040151>



Plug, nom. voltage: 500 V, nominal current: 24 A, number of positions: 6, connection method: Spring-cage connection, Rated cross section: 2.5 mm<sup>2</sup>, cross section: 0.08 mm<sup>2</sup>- 4 mm<sup>2</sup>, color: gray

---

## SPB 2,5/ 7 - Plug

3040164

<https://www.phoenixcontact.com/in/products/3040164>



Plug, nom. voltage: 500 V, nominal current: 24 A, number of positions: 7, connection method: Spring-cage connection, Rated cross section: 2.5 mm<sup>2</sup>, cross section: 0.08 mm<sup>2</sup>- 4 mm<sup>2</sup>, color: gray

# ST 2,5-TWIN-TG/1P - Disconnect terminal block

3040847

<https://www.phoenixcontact.com/in/products/3040847>

## SPB 2,5/ 8 - Plug

3040177

<https://www.phoenixcontact.com/in/products/3040177>



Plug, nom. voltage: 500 V, nominal current: 24 A, number of positions: 8, connection method: Spring-cage connection, Rated cross section: 2.5 mm<sup>2</sup>, cross section: 0.08 mm<sup>2</sup>- 4 mm<sup>2</sup>, color: gray

---

## SPB 2,5/ 9 - Plug

3040180

<https://www.phoenixcontact.com/in/products/3040180>



Plug, nom. voltage: 500 V, nominal current: 24 A, number of positions: 9, connection method: Spring-cage connection, Rated cross section: 2.5 mm<sup>2</sup>, cross section: 0.08 mm<sup>2</sup>- 4 mm<sup>2</sup>, color: gray

# ST 2,5-TWIN-TG/1P - Disconnect terminal block

3040847

<https://www.phoenixcontact.com/in/products/3040847>

## SPB 2,5/10 - Plug

3040193

<https://www.phoenixcontact.com/in/products/3040193>



Plug, nom. voltage: 500 V, nominal current: 24 A, number of positions: 10, connection method: Spring-cage connection, Rated cross section: 2.5 mm<sup>2</sup>, cross section: 0.08 mm<sup>2</sup>- 4 mm<sup>2</sup>, color: gray

---

## SPB 2,5/11 - Plug

3040203

<https://www.phoenixcontact.com/in/products/3040203>



Plug, nom. voltage: 500 V, nominal current: 24 A, number of positions: 11, connection method: Spring-cage connection, Rated cross section: 2.5 mm<sup>2</sup>, cross section: 0.08 mm<sup>2</sup>- 4 mm<sup>2</sup>, color: gray

# ST 2,5-TWIN-TG/1P - Disconnect terminal block

3040847

<https://www.phoenixcontact.com/in/products/3040847>

## SPB 2,5/12 - Plug

3040216

<https://www.phoenixcontact.com/in/products/3040216>



Plug, nom. voltage: 500 V, nominal current: 24 A, number of positions: 12, connection method: Spring-cage connection, Rated cross section: 2.5 mm<sup>2</sup>, cross section: 0.08 mm<sup>2</sup>- 4 mm<sup>2</sup>, color: gray

---

## SPB 2,5/13 - Plug

3040229

<https://www.phoenixcontact.com/in/products/3040229>



Plug, nom. voltage: 500 V, nominal current: 24 A, number of positions: 13, connection method: Spring-cage connection, Rated cross section: 2.5 mm<sup>2</sup>, cross section: 0.08 mm<sup>2</sup>- 4 mm<sup>2</sup>, color: gray

# ST 2,5-TWIN-TG/1P - Disconnect terminal block

3040847

<https://www.phoenixcontact.com/in/products/3040847>

## SPB 2,5/14 - Plug

3040232

<https://www.phoenixcontact.com/in/products/3040232>



Plug, nom. voltage: 500 V, nominal current: 24 A, number of positions: 14, connection method: Spring-cage connection, Rated cross section: 2.5 mm<sup>2</sup>, cross section: 0.08 mm<sup>2</sup>- 4 mm<sup>2</sup>, color: gray

---

## SPB 2,5/15 - Plug

3040245

<https://www.phoenixcontact.com/in/products/3040245>



Plug, nom. voltage: 500 V, nominal current: 24 A, number of positions: 15, connection method: Spring-cage connection, Rated cross section: 2.5 mm<sup>2</sup>, cross section: 0.08 mm<sup>2</sup>- 4 mm<sup>2</sup>, color: gray

# ST 2,5-TWIN-TG/1P - Disconnect terminal block

3040847

<https://www.phoenixcontact.com/in/products/3040847>

## SPB 2,5/ 1 BU - Plug

3040724

<https://www.phoenixcontact.com/in/products/3040724>



Plug, nom. voltage: 500 V, nominal current: 24 A, number of positions: 1, connection method: Spring-cage connection, Rated cross section: 2.5 mm<sup>2</sup>, cross section: 0.08 mm<sup>2</sup>- 4 mm<sup>2</sup>, color: blue

---

## SPB 2,5/ 1 GNYE - Plug

3040711

<https://www.phoenixcontact.com/in/products/3040711>



Plug, nom. voltage: 500 V, nominal current: 24 A, number of positions: 1, connection method: Spring-cage connection, Rated cross section: 2.5 mm<sup>2</sup>, cross section: 0.08 mm<sup>2</sup>- 4 mm<sup>2</sup>, color: green-yellow

# ST 2,5-TWIN-TG/1P - Disconnect terminal block

3040847

<https://www.phoenixcontact.com/in/products/3040847>

## SPDB 2,5/ 1 - Plug

3040407

<https://www.phoenixcontact.com/in/products/3040407>



Plug, nom. voltage: 500 V, nominal current: 24 A, number of positions: 1, connection method: Spring-cage connection, Rated cross section: 2.5 mm<sup>2</sup>, cross section: 0.08 mm<sup>2</sup>- 4 mm<sup>2</sup>, color: gray

---

## SPDB 2,5/ 2 - Plug

3040410

<https://www.phoenixcontact.com/in/products/3040410>



Plug, nom. voltage: 500 V, nominal current: 24 A, number of positions: 2, connection method: Spring-cage connection, Rated cross section: 2.5 mm<sup>2</sup>, cross section: 0.08 mm<sup>2</sup>- 4 mm<sup>2</sup>, color: gray



# ST 2,5-TWIN-TG/1P - Disconnect terminal block

3040847

<https://www.phoenixcontact.com/in/products/3040847>

## SPDB 2,5/ 3 - Plug

3040423

<https://www.phoenixcontact.com/in/products/3040423>



Plug, nom. voltage: 500 V, nominal current: 24 A, number of positions: 3, connection method: Spring-cage connection, Rated cross section: 2.5 mm<sup>2</sup>, cross section: 0.08 mm<sup>2</sup>- 4 mm<sup>2</sup>, color: gray

---

## SPDB 2,5/ 4 - Plug

3040436

<https://www.phoenixcontact.com/in/products/3040436>



Plug, nom. voltage: 500 V, nominal current: 24 A, number of positions: 4, connection method: Spring-cage connection, Rated cross section: 2.5 mm<sup>2</sup>, cross section: 0.08 mm<sup>2</sup>- 4 mm<sup>2</sup>, color: gray

# ST 2,5-TWIN-TG/1P - Disconnect terminal block

3040847

<https://www.phoenixcontact.com/in/products/3040847>

## SPDB 2,5/ 5 - Plug

3040449

<https://www.phoenixcontact.com/in/products/3040449>



Plug, nom. voltage: 500 V, nominal current: 24 A, number of positions: 5, connection method: Spring-cage connection, Rated cross section: 2.5 mm<sup>2</sup>, cross section: 0.08 mm<sup>2</sup>- 4 mm<sup>2</sup>, color: gray

---

## SPDB 2,5/ 6 - Plug

3040452

<https://www.phoenixcontact.com/in/products/3040452>



Plug, nom. voltage: 500 V, nominal current: 24 A, number of positions: 6, connection method: Spring-cage connection, Rated cross section: 2.5 mm<sup>2</sup>, cross section: 0.08 mm<sup>2</sup>- 4 mm<sup>2</sup>, color: gray

# ST 2,5-TWIN-TG/1P - Disconnect terminal block

3040847

<https://www.phoenixcontact.com/in/products/3040847>

## SPDB 2,5/ 7 - Plug

3040465

<https://www.phoenixcontact.com/in/products/3040465>



Plug, nom. voltage: 500 V, nominal current: 24 A, number of positions: 7, connection method: Spring-cage connection, Rated cross section: 2.5 mm<sup>2</sup>, cross section: 0.08 mm<sup>2</sup>- 4 mm<sup>2</sup>, color: gray

---

## SPDB 2,5/ 8 - Plug

3040478

<https://www.phoenixcontact.com/in/products/3040478>



Plug, nom. voltage: 500 V, nominal current: 24 A, number of positions: 8, connection method: Spring-cage connection, Rated cross section: 2.5 mm<sup>2</sup>, cross section: 0.08 mm<sup>2</sup>- 4 mm<sup>2</sup>, color: gray

# ST 2,5-TWIN-TG/1P - Disconnect terminal block

3040847

<https://www.phoenixcontact.com/in/products/3040847>

## SPDB 2,5/ 9 - Plug

3040481

<https://www.phoenixcontact.com/in/products/3040481>



Plug, nom. voltage: 500 V, nominal current: 24 A, number of positions: 9, connection method: Spring-cage connection, Rated cross section: 2.5 mm<sup>2</sup>, cross section: 0.08 mm<sup>2</sup>- 4 mm<sup>2</sup>, color: gray

---

## SPDB 2,5/10 - Plug

3040494

<https://www.phoenixcontact.com/in/products/3040494>



Plug, nom. voltage: 500 V, nominal current: 24 A, number of positions: 10, connection method: Spring-cage connection, Rated cross section: 2.5 mm<sup>2</sup>, cross section: 0.08 mm<sup>2</sup>- 4 mm<sup>2</sup>, color: gray

# ST 2,5-TWIN-TG/1P - Disconnect terminal block

3040847

<https://www.phoenixcontact.com/in/products/3040847>

## SPDB 2,5/11 - Plug

3040504

<https://www.phoenixcontact.com/in/products/3040504>



Plug, nom. voltage: 500 V, nominal current: 24 A, number of positions: 11, connection method: Spring-cage connection, Rated cross section: 2.5 mm<sup>2</sup>, cross section: 0.08 mm<sup>2</sup>- 4 mm<sup>2</sup>, color: gray

---

## SPDB 2,5/12 - Plug

3040517

<https://www.phoenixcontact.com/in/products/3040517>



Plug, nom. voltage: 500 V, nominal current: 24 A, number of positions: 12, connection method: Spring-cage connection, Rated cross section: 2.5 mm<sup>2</sup>, cross section: 0.08 mm<sup>2</sup>- 4 mm<sup>2</sup>, color: gray

# ST 2,5-TWIN-TG/1P - Disconnect terminal block

3040847

<https://www.phoenixcontact.com/in/products/3040847>

## SPDB 2,5/13 - Plug

3040520

<https://www.phoenixcontact.com/in/products/3040520>



Plug, nom. voltage: 500 V, nominal current: 24 A, number of positions: 13, connection method: Spring-cage connection, Rated cross section: 2.5 mm<sup>2</sup>, cross section: 0.08 mm<sup>2</sup>- 4 mm<sup>2</sup>, color: gray

---

## SPDB 2,5/14 - Plug

3040533

<https://www.phoenixcontact.com/in/products/3040533>



Plug, nom. voltage: 500 V, nominal current: 24 A, number of positions: 14, connection method: Spring-cage connection, Rated cross section: 2.5 mm<sup>2</sup>, cross section: 0.08 mm<sup>2</sup>- 4 mm<sup>2</sup>, color: gray

# ST 2,5-TWIN-TG/1P - Disconnect terminal block

3040847

<https://www.phoenixcontact.com/in/products/3040847>

## SPDB 2,5/15 - Plug

3040546

<https://www.phoenixcontact.com/in/products/3040546>



Plug, nom. voltage: 500 V, nominal current: 24 A, number of positions: 15, connection method: Spring-cage connection, Rated cross section: 2.5 mm<sup>2</sup>, cross section: 0.08 mm<sup>2</sup>- 4 mm<sup>2</sup>, color: gray

---

## SPDB 2,5/ 1 BU - Plug

3040737

<https://www.phoenixcontact.com/in/products/3040737>



Plug, nom. voltage: 500 V, nominal current: 24 A, number of positions: 1, connection method: Spring-cage connection, Rated cross section: 2.5 mm<sup>2</sup>, cross section: 0.08 mm<sup>2</sup>- 4 mm<sup>2</sup>, color: blue

# ST 2,5-TWIN-TG/1P - Disconnect terminal block

3040847

<https://www.phoenixcontact.com/in/products/3040847>

## SPDB 2,5/ 1 GNYE - Plug

3040740

<https://www.phoenixcontact.com/in/products/3040740>

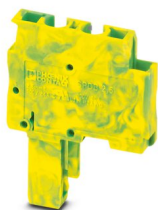

Plug, nom. voltage: 500 V, nominal current: 24 A, number of positions: 1, connection method: Spring-cage connection, Rated cross section: 2.5 mm<sup>2</sup>, cross section: 0.08 mm<sup>2</sup>- 4 mm<sup>2</sup>, color: green-yellow

---

## SP-H 2,5/ 1 - Plug

3210619

<https://www.phoenixcontact.com/in/products/3210619>



Plug, nom. voltage: 500 V, nominal current: 24 A, number of positions: 1, connection method: Spring-cage connection, Rated cross section: 2.5 mm<sup>2</sup>, cross section: 0.08 mm<sup>2</sup>- 4 mm<sup>2</sup>, color: gray



# ST 2,5-TWIN-TG/1P - Disconnect terminal block

3040847

<https://www.phoenixcontact.com/in/products/3040847>

## SP-H 2,5/ 2 - Plug

3210622

<https://www.phoenixcontact.com/in/products/3210622>



Plug, nom. voltage: 500 V, nominal current: 24 A, number of positions: 2, connection method: Spring-cage connection, Rated cross section: 2.5 mm<sup>2</sup>, cross section: 0.08 mm<sup>2</sup>- 4 mm<sup>2</sup>, color: gray

---

## SP-H 2,5/ 3 - Plug

3210635

<https://www.phoenixcontact.com/in/products/3210635>



Plug, nom. voltage: 500 V, nominal current: 24 A, number of positions: 3, connection method: Spring-cage connection, Rated cross section: 2.5 mm<sup>2</sup>, cross section: 0.08 mm<sup>2</sup>- 4 mm<sup>2</sup>, color: gray

# ST 2,5-TWIN-TG/1P - Disconnect terminal block

3040847

<https://www.phoenixcontact.com/in/products/3040847>

## SP-H 2,5/ 4 - Plug

3210648

<https://www.phoenixcontact.com/in/products/3210648>



Plug, nom. voltage: 500 V, nominal current: 24 A, number of positions: 4, connection method: Spring-cage connection, Rated cross section: 2.5 mm<sup>2</sup>, cross section: 0.08 mm<sup>2</sup>- 4 mm<sup>2</sup>, color: gray

---

## SP-H 2,5/ 5 - Plug

3210651

<https://www.phoenixcontact.com/in/products/3210651>



Plug, nom. voltage: 500 V, nominal current: 24 A, number of positions: 5, connection method: Spring-cage connection, Rated cross section: 2.5 mm<sup>2</sup>, cross section: 0.08 mm<sup>2</sup>- 4 mm<sup>2</sup>, color: gray

# ST 2,5-TWIN-TG/1P - Disconnect terminal block

3040847

<https://www.phoenixcontact.com/in/products/3040847>

## SP-H 2,5/ 6 - Plug

3210664

<https://www.phoenixcontact.com/in/products/3210664>



Plug, nom. voltage: 500 V, nominal current: 24 A, number of positions: 6, connection method: Spring-cage connection, Rated cross section: 2.5 mm<sup>2</sup>, cross section: 0.08 mm<sup>2</sup>- 4 mm<sup>2</sup>, color: gray

---

## SP-H 2,5/ 7 - Plug

3210677

<https://www.phoenixcontact.com/in/products/3210677>



Plug, nom. voltage: 500 V, nominal current: 24 A, number of positions: 7, connection method: Spring-cage connection, Rated cross section: 2.5 mm<sup>2</sup>, cross section: 0.08 mm<sup>2</sup>- 4 mm<sup>2</sup>, color: gray

# ST 2,5-TWIN-TG/1P - Disconnect terminal block

3040847

<https://www.phoenixcontact.com/in/products/3040847>

## SP-H 2,5/ 8 - Plug

3210680

<https://www.phoenixcontact.com/in/products/3210680>



Plug, nom. voltage: 500 V, nominal current: 24 A, number of positions: 8, connection method: Spring-cage connection, Rated cross section: 2.5 mm<sup>2</sup>, cross section: 0.08 mm<sup>2</sup>- 4 mm<sup>2</sup>, color: gray

---

## SP-H 2,5/ 9 - Plug

3210693

<https://www.phoenixcontact.com/in/products/3210693>



Plug, nom. voltage: 500 V, nominal current: 24 A, number of positions: 9, connection method: Spring-cage connection, Rated cross section: 2.5 mm<sup>2</sup>, cross section: 0.08 mm<sup>2</sup>- 4 mm<sup>2</sup>, color: gray

# ST 2,5-TWIN-TG/1P - Disconnect terminal block

3040847

<https://www.phoenixcontact.com/in/products/3040847>

## SP-H 2,5/10 - Plug

3210703

<https://www.phoenixcontact.com/in/products/3210703>



Plug, nom. voltage: 500 V, nominal current: 24 A, number of positions: 10, connection method: Spring-cage connection, Rated cross section: 2.5 mm<sup>2</sup>, cross section: 0.08 mm<sup>2</sup>- 4 mm<sup>2</sup>, color: gray

---

## SP-H 2,5/11 - Plug

3210716

<https://www.phoenixcontact.com/in/products/3210716>



Plug, nom. voltage: 500 V, nominal current: 24 A, number of positions: 11, connection method: Spring-cage connection, Rated cross section: 2.5 mm<sup>2</sup>, cross section: 0.08 mm<sup>2</sup>- 4 mm<sup>2</sup>, color: gray

# ST 2,5-TWIN-TG/1P - Disconnect terminal block

3040847

<https://www.phoenixcontact.com/in/products/3040847>

## SP-H 2,5/12 - Plug

3210729

<https://www.phoenixcontact.com/in/products/3210729>



Plug, nom. voltage: 500 V, nominal current: 24 A, number of positions: 12, connection method: Spring-cage connection, Rated cross section: 2.5 mm<sup>2</sup>, cross section: 0.08 mm<sup>2</sup>- 4 mm<sup>2</sup>, color: gray

---

## SP-H 2,5/13 - Plug

3210732

<https://www.phoenixcontact.com/in/products/3210732>



Plug, nom. voltage: 500 V, nominal current: 24 A, number of positions: 13, connection method: Spring-cage connection, Rated cross section: 2.5 mm<sup>2</sup>, cross section: 0.08 mm<sup>2</sup>- 4 mm<sup>2</sup>, color: gray

# ST 2,5-TWIN-TG/1P - Disconnect terminal block

3040847

<https://www.phoenixcontact.com/in/products/3040847>

## SP-H 2,5/14 - Plug

3210745

<https://www.phoenixcontact.com/in/products/3210745>



Plug, nom. voltage: 500 V, nominal current: 24 A, number of positions: 14, connection method: Spring-cage connection, Rated cross section: 2.5 mm<sup>2</sup>, cross section: 0.08 mm<sup>2</sup>- 4 mm<sup>2</sup>, color: gray

---

## SP-H 2,5/15 - Plug

3210758

<https://www.phoenixcontact.com/in/products/3210758>



Plug, nom. voltage: 500 V, nominal current: 24 A, number of positions: 15, connection method: Spring-cage connection, Rated cross section: 2.5 mm<sup>2</sup>, cross section: 0.08 mm<sup>2</sup>- 4 mm<sup>2</sup>, color: gray

# ST 2,5-TWIN-TG/1P - Disconnect terminal block

3040847

<https://www.phoenixcontact.com/in/products/3040847>

## SP-H 2,5/ 1 BU - Plug

3210761

<https://www.phoenixcontact.com/in/products/3210761>



Plug, nom. voltage: 500 V, nominal current: 24 A, number of positions: 1, connection method: Spring-cage connection, Rated cross section: 2.5 mm<sup>2</sup>, cross section: 0.08 mm<sup>2</sup>- 4 mm<sup>2</sup>, color: blue

---

## SP-H 2,5/ 1 GNYE - Plug

3210774

<https://www.phoenixcontact.com/in/products/3210774>



Plug, nom. voltage: 500 V, nominal current: 24 A, number of positions: 1, connection method: Spring-cage connection, Rated cross section: 2.5 mm<sup>2</sup>, cross section: 0.08 mm<sup>2</sup>- 4 mm<sup>2</sup>, color: green-yellow



# ST 2,5-TWIN-TG/1P - Disconnect terminal block

3040847

<https://www.phoenixcontact.com/in/products/3040847>

## SP-H 2,5/ 1-L - Plug

3210787

<https://www.phoenixcontact.com/in/products/3210787>



Plug, nom. voltage: 500 V, nominal current: 24 A, number of positions: 1, connection method: Spring-cage connection, Rated cross section: 2.5 mm<sup>2</sup>, cross section: 0.08 mm<sup>2</sup>- 4 mm<sup>2</sup>, color: gray

---

## SP-H 2,5/ 1-L BU - Plug

3210790

<https://www.phoenixcontact.com/in/products/3210790>



Plug, nom. voltage: 500 V, nominal current: 24 A, number of positions: 1, connection method: Spring-cage connection, Rated cross section: 2.5 mm<sup>2</sup>, cross section: 0.08 mm<sup>2</sup>- 4 mm<sup>2</sup>, color: blue

# ST 2,5-TWIN-TG/1P - Disconnect terminal block

3040847

<https://www.phoenixcontact.com/in/products/3040847>

## SP-H 2,5/ 1-L GNYE - Plug

3210800

<https://www.phoenixcontact.com/in/products/3210800>



Plug, nom. voltage: 500 V, nominal current: 24 A, number of positions: 1, connection method: Spring-cage connection, Rated cross section: 2.5 mm<sup>2</sup>, cross section: 0.08 mm<sup>2</sup>- 4 mm<sup>2</sup>, color: green-yellow

---

## SP-H 2,5/ 1-M - Plug

3210813

<https://www.phoenixcontact.com/in/products/3210813>



Plug, nom. voltage: 500 V, nominal current: 24 A, number of positions: 1, connection method: Spring-cage connection, Rated cross section: 2.5 mm<sup>2</sup>, cross section: 0.08 mm<sup>2</sup>- 4 mm<sup>2</sup>, color: gray

# ST 2,5-TWIN-TG/1P - Disconnect terminal block

3040847

<https://www.phoenixcontact.com/in/products/3040847>

## SP-H 2,5/ 1-M BU - Plug

3210826

<https://www.phoenixcontact.com/in/products/3210826>



Plug, nom. voltage: 500 V, nominal current: 24 A, number of positions: 1, connection method: Spring-cage connection, Rated cross section: 2.5 mm<sup>2</sup>, cross section: 0.08 mm<sup>2</sup>- 4 mm<sup>2</sup>, color: blue

---

## SP-H 2,5/ 1-M GNYE - Plug

3210839

<https://www.phoenixcontact.com/in/products/3210839>



Plug, nom. voltage: 500 V, nominal current: 24 A, number of positions: 1, connection method: Spring-cage connection, Rated cross section: 2.5 mm<sup>2</sup>, cross section: 0.08 mm<sup>2</sup>- 4 mm<sup>2</sup>, color: green-yellow

# ST 2,5-TWIN-TG/1P - Disconnect terminal block

3040847

<https://www.phoenixcontact.com/in/products/3040847>

## SP-H 2,5/ 1-R - Plug

3210842

<https://www.phoenixcontact.com/in/products/3210842>



Plug, nom. voltage: 500 V, nominal current: 24 A, number of positions: 1, connection method: Spring-cage connection, Rated cross section: 2.5 mm<sup>2</sup>, cross section: 0.08 mm<sup>2</sup>- 4 mm<sup>2</sup>, color: gray

---

## SP-H 2,5/ 1-R BU - Plug

3210855

<https://www.phoenixcontact.com/in/products/3210855>



Plug, nom. voltage: 500 V, nominal current: 24 A, number of positions: 1, connection method: Spring-cage connection, Rated cross section: 2.5 mm<sup>2</sup>, cross section: 0.08 mm<sup>2</sup>- 4 mm<sup>2</sup>, color: blue

# ST 2,5-TWIN-TG/1P - Disconnect terminal block

3040847

<https://www.phoenixcontact.com/in/products/3040847>

## SP-H 2,5/ 1-R GNYE - Plug

3210868

<https://www.phoenixcontact.com/in/products/3210868>



Plug, nom. voltage: 500 V, nominal current: 24 A, number of positions: 1, connection method: Spring-cage connection, Rated cross section: 2.5 mm<sup>2</sup>, cross section: 0.08 mm<sup>2</sup>- 4 mm<sup>2</sup>, color: green-yellow

---

## SPV 2,5/ 1 - Plug

3041710

<https://www.phoenixcontact.com/in/products/3041710>



Plug, nom. voltage: 500 V, nominal current: 24 A, number of positions: 1, connection method: Spring-cage connection, Rated cross section: 2.5 mm<sup>2</sup>, cross section: 0.08 mm<sup>2</sup>- 4 mm<sup>2</sup>, color: gray

# ST 2,5-TWIN-TG/1P - Disconnect terminal block

3040847

<https://www.phoenixcontact.com/in/products/3040847>

## SPV 2,5/ 2 - Plug

3041723

<https://www.phoenixcontact.com/in/products/3041723>



Plug, nom. voltage: 500 V, nominal current: 24 A, number of positions: 2, connection method: Spring-cage connection, Rated cross section: 2.5 mm<sup>2</sup>, cross section: 0.08 mm<sup>2</sup>- 4 mm<sup>2</sup>, color: gray

---

## SPV 2,5/ 3 - Plug

3041736

<https://www.phoenixcontact.com/in/products/3041736>



Plug, nom. voltage: 500 V, nominal current: 24 A, number of positions: 3, connection method: Spring-cage connection, Rated cross section: 2.5 mm<sup>2</sup>, cross section: 0.08 mm<sup>2</sup>- 4 mm<sup>2</sup>, color: gray

# ST 2,5-TWIN-TG/1P - Disconnect terminal block

3040847

<https://www.phoenixcontact.com/in/products/3040847>

## SPV 2,5/ 4 - Plug

3041749

<https://www.phoenixcontact.com/in/products/3041749>



Plug, nom. voltage: 500 V, nominal current: 24 A, number of positions: 4, connection method: Spring-cage connection, Rated cross section: 2.5 mm<sup>2</sup>, cross section: 0.08 mm<sup>2</sup>- 4 mm<sup>2</sup>, color: gray

---

## SPV 2,5/ 5 - Plug

3041752

<https://www.phoenixcontact.com/in/products/3041752>



Plug, nom. voltage: 500 V, nominal current: 24 A, number of positions: 5, connection method: Spring-cage connection, Rated cross section: 2.5 mm<sup>2</sup>, cross section: 0.08 mm<sup>2</sup>- 4 mm<sup>2</sup>, color: gray

# ST 2,5-TWIN-TG/1P - Disconnect terminal block

3040847

<https://www.phoenixcontact.com/in/products/3040847>

## SPV 2,5/ 6 - Plug

3041765

<https://www.phoenixcontact.com/in/products/3041765>



Plug, nom. voltage: 500 V, nominal current: 24 A, number of positions: 6, connection method: Spring-cage connection, Rated cross section: 2.5 mm<sup>2</sup>, cross section: 0.08 mm<sup>2</sup>- 4 mm<sup>2</sup>, color: gray

---

## SPV 2,5/ 7 - Plug

3041778

<https://www.phoenixcontact.com/in/products/3041778>



Plug, nom. voltage: 500 V, nominal current: 24 A, number of positions: 7, connection method: Spring-cage connection, Rated cross section: 2.5 mm<sup>2</sup>, cross section: 0.08 mm<sup>2</sup>- 4 mm<sup>2</sup>, color: gray



# ST 2,5-TWIN-TG/1P - Disconnect terminal block

3040847

<https://www.phoenixcontact.com/in/products/3040847>

## SPV 2,5/ 8 - Plug

3041781

<https://www.phoenixcontact.com/in/products/3041781>



Plug, nom. voltage: 500 V, nominal current: 24 A, number of positions: 8, connection method: Spring-cage connection, Rated cross section: 2.5 mm<sup>2</sup>, cross section: 0.08 mm<sup>2</sup>- 4 mm<sup>2</sup>, color: gray

---

## SPV 2,5/ 9 - Plug

3041794

<https://www.phoenixcontact.com/in/products/3041794>



Plug, nom. voltage: 500 V, nominal current: 24 A, number of positions: 9, connection method: Spring-cage connection, Rated cross section: 2.5 mm<sup>2</sup>, cross section: 0.08 mm<sup>2</sup>- 4 mm<sup>2</sup>, color: gray

# ST 2,5-TWIN-TG/1P - Disconnect terminal block

3040847

<https://www.phoenixcontact.com/in/products/3040847>

## SPV 2,5/10 - Plug

3041804

<https://www.phoenixcontact.com/in/products/3041804>



Plug, nom. voltage: 500 V, nominal current: 24 A, number of positions: 10, connection method: Spring-cage connection, Rated cross section: 2.5 mm<sup>2</sup>, cross section: 0.08 mm<sup>2</sup>- 4 mm<sup>2</sup>, color: gray

---

## SPV 2,5/11 - Plug

3041817

<https://www.phoenixcontact.com/in/products/3041817>



Plug, nom. voltage: 500 V, nominal current: 24 A, number of positions: 11, connection method: Spring-cage connection, Rated cross section: 2.5 mm<sup>2</sup>, cross section: 0.08 mm<sup>2</sup>- 4 mm<sup>2</sup>, color: gray

# ST 2,5-TWIN-TG/1P - Disconnect terminal block

3040847

<https://www.phoenixcontact.com/in/products/3040847>

## SPV 2,5/12 - Plug

3041820

<https://www.phoenixcontact.com/in/products/3041820>



Plug, nom. voltage: 500 V, nominal current: 24 A, number of positions: 12, connection method: Spring-cage connection, Rated cross section: 2.5 mm<sup>2</sup>, cross section: 0.08 mm<sup>2</sup>- 4 mm<sup>2</sup>, color: gray

---

## SPV 2,5/13 - Plug

3041833

<https://www.phoenixcontact.com/in/products/3041833>



Plug, nom. voltage: 500 V, nominal current: 24 A, number of positions: 13, connection method: Spring-cage connection, Rated cross section: 2.5 mm<sup>2</sup>, cross section: 0.08 mm<sup>2</sup>- 4 mm<sup>2</sup>, color: gray

# ST 2,5-TWIN-TG/1P - Disconnect terminal block

3040847

<https://www.phoenixcontact.com/in/products/3040847>

## SPV 2,5/14 - Plug

3041846

<https://www.phoenixcontact.com/in/products/3041846>



Plug, nom. voltage: 500 V, nominal current: 24 A, number of positions: 14, connection method: Spring-cage connection, Rated cross section: 2.5 mm<sup>2</sup>, cross section: 0.08 mm<sup>2</sup>- 4 mm<sup>2</sup>, color: gray

---

## SPV 2,5/15 - Plug

3041859

<https://www.phoenixcontact.com/in/products/3041859>



Plug, nom. voltage: 500 V, nominal current: 24 A, number of positions: 15, connection method: Spring-cage connection, Rated cross section: 2.5 mm<sup>2</sup>, cross section: 0.08 mm<sup>2</sup>- 4 mm<sup>2</sup>, color: gray

# ST 2,5-TWIN-TG/1P - Disconnect terminal block

3040847

<https://www.phoenixcontact.com/in/products/3040847>

## SPV 2,5/ 1 BU - Plug

3061017

<https://www.phoenixcontact.com/in/products/3061017>



Plug, nom. voltage: 500 V, nominal current: 24 A, number of positions: 1, connection method: Spring-cage connection, Rated cross section: 2.5 mm<sup>2</sup>, cross section: 0.08 mm<sup>2</sup>- 4 mm<sup>2</sup>, color: blue

---

## SPV 2,5/ 1 GNYE - Plug

3061020

<https://www.phoenixcontact.com/in/products/3061020>



Plug, nom. voltage: 500 V, nominal current: 24 A, number of positions: 1, connection method: Spring-cage connection, Rated cross section: 2.5 mm<sup>2</sup>, cross section: 0.08 mm<sup>2</sup>- 4 mm<sup>2</sup>, color: green-yellow

# ST 2,5-TWIN-TG/1P - Disconnect terminal block

3040847

<https://www.phoenixcontact.com/in/products/3040847>

## SPV 2,5/ 1-L - Plug

3041024

<https://www.phoenixcontact.com/in/products/3041024>



Plug, nom. voltage: 500 V, nominal current: 24 A, number of positions: 1, connection method: Spring-cage connection, Rated cross section: 2.5 mm<sup>2</sup>, cross section: 0.08 mm<sup>2</sup>- 4 mm<sup>2</sup>, color: gray

---

## SPV 2,5/ 1-L BU - Plug

3041037

<https://www.phoenixcontact.com/in/products/3041037>



Plug, nom. voltage: 500 V, nominal current: 24 A, number of positions: 1, connection method: Spring-cage connection, Rated cross section: 2.5 mm<sup>2</sup>, cross section: 0.08 mm<sup>2</sup>- 4 mm<sup>2</sup>, color: blue

# ST 2,5-TWIN-TG/1P - Disconnect terminal block

3040847

<https://www.phoenixcontact.com/in/products/3040847>

## SPV 2,5/ 1-L GNYE - Plug

3041040

<https://www.phoenixcontact.com/in/products/3041040>



Plug, nom. voltage: 500 V, nominal current: 24 A, number of positions: 1, connection method: Spring-cage connection, Rated cross section: 2.5 mm<sup>2</sup>, cross section: 0.08 mm<sup>2</sup>- 4 mm<sup>2</sup>, color: green-yellow

---

## SPV 2,5/ 1-M - Plug

3041053

<https://www.phoenixcontact.com/in/products/3041053>



Plug, nom. voltage: 500 V, nominal current: 24 A, number of positions: 1, connection method: Spring-cage connection, Rated cross section: 2.5 mm<sup>2</sup>, cross section: 0.08 mm<sup>2</sup>- 4 mm<sup>2</sup>, color: gray

# ST 2,5-TWIN-TG/1P - Disconnect terminal block

3040847

<https://www.phoenixcontact.com/in/products/3040847>

## SPV 2,5/ 1-M BU - Plug

3041066

<https://www.phoenixcontact.com/in/products/3041066>



Plug, nom. voltage: 500 V, nominal current: 24 A, number of positions: 1, connection method: Spring-cage connection, Rated cross section: 2.5 mm<sup>2</sup>, cross section: 0.08 mm<sup>2</sup>- 4 mm<sup>2</sup>, color: blue

---

## SPV 2,5/ 1-M GNYE - Plug

3041079

<https://www.phoenixcontact.com/in/products/3041079>



Plug, nom. voltage: 500 V, nominal current: 24 A, number of positions: 1, connection method: Spring-cage connection, Rated cross section: 2.5 mm<sup>2</sup>, cross section: 0.08 mm<sup>2</sup>- 4 mm<sup>2</sup>, color: green-yellow



# ST 2,5-TWIN-TG/1P - Disconnect terminal block

3040847

<https://www.phoenixcontact.com/in/products/3040847>

## SPV 2,5/ 1-R - Plug

3041082

<https://www.phoenixcontact.com/in/products/3041082>



Plug, nom. voltage: 500 V, nominal current: 24 A, number of positions: 1, connection method: Spring-cage connection, Rated cross section: 2.5 mm<sup>2</sup>, cross section: 0.08 mm<sup>2</sup>- 4 mm<sup>2</sup>, color: gray

---

## SPV 2,5/ 1-R BU - Plug

3041095

<https://www.phoenixcontact.com/in/products/3041095>



Plug, nom. voltage: 500 V, nominal current: 24 A, number of positions: 1, connection method: Spring-cage connection, Rated cross section: 2.5 mm<sup>2</sup>, cross section: 0.08 mm<sup>2</sup>- 4 mm<sup>2</sup>, color: blue

# ST 2,5-TWIN-TG/1P - Disconnect terminal block

3040847

<https://www.phoenixcontact.com/in/products/3040847>

## SPV 2,5/ 1-R GNYE - Plug

3041105

<https://www.phoenixcontact.com/in/products/3041105>



Plug, nom. voltage: 500 V, nominal current: 24 A, number of positions: 1, connection method: Spring-cage connection, Rated cross section: 2.5 mm<sup>2</sup>, cross section: 0.08 mm<sup>2</sup>- 4 mm<sup>2</sup>, color: green-yellow

---

## P-FU 5X20-5 - Fuse plug

3209235

<https://www.phoenixcontact.com/in/products/3209235>



Fuse plug, Suitable for terminal blocks with a width of 5.2 mm and above with TG zone, nom. voltage: 400 V, nominal current: 6.3 A, connection method: Plug-in connection, fuse type: G / 5 x 20, mounting type: Plug-in mounting, color: black

# ST 2,5-TWIN-TG/1P - Disconnect terminal block

3040847

<https://www.phoenixcontact.com/in/products/3040847>

## P-FU 5X20 LED 24-5 - Fuse plug

3209248

<https://www.phoenixcontact.com/in/products/3209248>



Fuse plug, Suitable for terminal blocks with a width of 5.2 mm and above with TG zone, nom. voltage: 24 V, nominal current: 6.3 A, connection method: Plug-in connection, fuse type: G / 5 x 20, mounting type: Plug-in mounting, color: black

---

## P-FU 5X20 LED 60-5 - Fuse plug

3209251

<https://www.phoenixcontact.com/in/products/3209251>



Fuse plug, Suitable for terminal blocks with a width of 5.2 mm and above with TG zone, nom. voltage: 250 V, nominal current: 6.3 A, connection method: Plug-in connection, fuse type: G / 5 x 20, mounting type: Plug-in mounting, color: black

# ST 2,5-TWIN-TG/1P - Disconnect terminal block

3040847

<https://www.phoenixcontact.com/in/products/3040847>

## P-FU 5X20 LED 250-5 - Fuse plug

3209264

<https://www.phoenixcontact.com/in/products/3209264>



Fuse plug, Suitable for terminal blocks with a width of 5.2 mm and above with TG zone, nom. voltage: 250 V, nominal current: 6.3 A, connection method: Plug-in connection, fuse type: G / 5 x 20, mounting type: Plug-in mounting, color: black

---

## P-DI - Isolating plugs

3036783

<https://www.phoenixcontact.com/in/products/3036783>



Isolating plugs, length: 10.8 mm, width: 3.5 mm, height: 23.1 mm, color: orange

# ST 2,5-TWIN-TG/1P - Disconnect terminal block

3040847

<https://www.phoenixcontact.com/in/products/3040847>

## P-DI GY - Isolating plugs

3047390

<https://www.phoenixcontact.com/in/products/3047390>

Isolating plugs, length: 10.8 mm, width: 3.5 mm, height: 23.1 mm, color: gray



---

## P-FIX - Feed-through connector

3038956

<https://www.phoenixcontact.com/in/products/3038956>

Feed-through connector, length: 10.5 mm, width: 4 mm, color: gray



# ST 2,5-TWIN-TG/1P - Disconnect terminal block

3040847

<https://www.phoenixcontact.com/in/products/3040847>

## P-CO - Component connector

3036796

<https://www.phoenixcontact.com/in/products/3036796>



Component connector, for installing components that can be individually selected, nominal current: 6 A, pitch: 5.2 mm, length: 24.2 mm, width: 5.1 mm, height: 33.2 mm, number of positions: 1, color: gray

---

## P-CO 1N4007/R-L - Component connector

3032457

<https://www.phoenixcontact.com/in/products/3032457>



Component connector, with diode 1N4007, length: 24.2 mm, width: 5.2 mm, height: 33.3 mm, number of positions: 1, color: gray

# ST 2,5-TWIN-TG/1P - Disconnect terminal block



3040847

<https://www.phoenixcontact.com/in/products/3040847>

## P-CO 1N4007/L-R - Component connector

3032460

<https://www.phoenixcontact.com/in/products/3032460>



Component connector, with diode 1N4007, length: 24.2 mm, width: 5.2 mm, height: 33.3 mm, number of positions: 1, color: gray

---

Phoenix Contact 2023 © - all rights reserved

<https://www.phoenixcontact.com>

PHOENIX CONTACT (I) Pvt. Ltd.

A-58/2, Okhla Industrial Area, Phase - II, New Delhi-110 020

+91.1275.71420

[info@phoenixcontact.co.in](mailto:info@phoenixcontact.co.in)