

PTSM 0,5/ 2-PL-2,5 WH - Printed-circuit board connector



1709457

<https://www.phoenixcontact.com/in/products/1709457>

Please be informed that the data shown in this PDF document is generated from our Online Catalog. Please find the complete data in the user documentation. Our General Terms of Use for Downloads are valid.



PCB connector, nominal cross section: 0.5 mm², color: white, nominal current: 6 A, rated voltage (III/2): 160 V, contact surface: Tin, type of contact: Socket, number of potentials: 2, number of rows: 1, number of positions: 2, number of connections: 2, product range: PTSM 0,5/..-PL WH, pitch: 2.5 mm, connection method: Push-in spring connection, conductor/PCB connection direction: 0 °, plug-in system: COMBICON PTSM, locking: Snap-in locking, mounting: Self-locking flange, type of packaging: packed in cardboard

Your advantages

- White design: Stable color when welding and during use
- Time saving push-in connection, tools not required
- Defined contact force ensures that contact remains stable over the long term
- High current carrying capacity of 6 A in very compact dimensions
- Intuitive locking mechanism prevents accidental disconnection

Commercial Data

Item number	1709457
Packing unit	250 pc
Minimum order quantity	250 pc
Sales Key	AAA
Product Key	AAAFPE
GTIN	4055626130439
Weight per Piece (including packing)	0.78 g
Weight per Piece (excluding packing)	0.606 g
Customs tariff number	85366990
Country of origin	PL

PTSM 0,5/ 2-PL-2,5 WH - Printed-circuit board connector



1709457

<https://www.phoenixcontact.com/in/products/1709457>

Technical Data

Product properties

Type	Standard
Product line	COMBICON Connectors XS
Product type	PCB plug
Product family	PTSM 0,5/..-PL WH
Number of positions	2
Pitch	2.5 mm
Number of connections	2
Number of rows	1
Number of potentials	2

Electrical properties

Nominal current I_N	6 A
Nominal voltage U_N	160 V
Degree of pollution	3
Contact resistance	3 mΩ
Rated voltage (III/3)	100 V
Rated surge voltage (III/3)	2.5 kV
Rated voltage (III/2)	160 V
Rated surge voltage (III/2)	2.5 kV
Rated voltage (II/2)	320 V
Rated surge voltage (II/2)	2.5 kV

Connection data

Connection technology

Type	Standard
Connector system	COMBICON PTSM
Nominal cross section	0.5 mm ²
Type of contact	Socket

Interlock

Locking type	Snap-in locking
Mounting flange	Self-locking flange

Conductor connection

Connection method	Push-in spring connection
Conductor/PCB connection direction	0 °
Conductor cross section rigid	0.14 mm ² ... 0.5 mm ²
Conductor cross section flexible	0.2 mm ² ... 0.5 mm ² (up to 0.75 mm ² supported, with a stripping length of 7.5 mm and a rated insulation voltage of 32 V at III/2)
Conductor cross section AWG	24 ... 20
Conductor cross section flexible, with ferrule without plastic	0.25 mm ² ... 0.5 mm ²

PTSM 0,5/ 2-PL-2,5 WH - Printed-circuit board connector



1709457

<https://www.phoenixcontact.com/in/products/1709457>

sleeve	
Conductor cross section, flexible, with ferrule, with plastic sleeve	0.25 mm ² ... 0.34 mm ²
Cylindrical gauge a x b / diameter	- / 1.2 mm
Stripping length	6 mm

Material specifications

Material data - contact

Note	WEEE/RoHS-compliant, free of whiskers according to IEC 60068-2-82/JEDEC JESD 201
Contact material	Cu alloy
Surface characteristics	hot-dip tin-plated
Metal surface terminal point (top layer)	Tin (4 - 8 µm Sn)
Metal surface contact area (top layer)	Tin (4 - 8 µm Sn)

Material data - housing

Color (Housing)	white (9010)
Insulating material	PA
Insulating material group	I
CTI according to IEC 60112	600
Flammability rating according to UL 94	V0
Glow wire flammability index GWFI according to EN 60695-2-12	850
Glow wire ignition temperature GWIT according to EN 60695-2-13	775
Temperature for the ball pressure test according to EN 60695-10-2	125 °C

Material data – actuating element

Color ()	()
-----------	-----

Dimensions

Dimensional drawing	
Pitch	2.5 mm
Width [w]	11.46 mm
Height [h]	5.2 mm
Length [l]	15 mm

Mechanical tests

Test for conductor damage and slackening

Specification	IEC 60999-1:1999-11
Result	Test passed

PTSM 0,5/ 2-PL-2,5 WH - Printed-circuit board connector



1709457

<https://www.phoenixcontact.com/in/products/1709457>

Repeated connection and disconnection

Specification	IEC 60999-1:1999-11
Result	Test passed

Pull-out test

Specification	IEC 60999-1:1999-11
Conductor cross section/conductor type/tractive force setpoint/actual value	0.14 mm ² / solid / > 10 N
	0.25 mm ² / flexible / > 10 N
	0.5 mm ² / solid / > 20 N
	0.75 mm ² / flexible / > 30 N

Insertion and withdrawal forces

Result	Test passed
No. of cycles	10
Insertion strength per pos. approx.	5 N
Withdraw strength per pos. approx.	4 N

Contact holder in insert

Specification	IEC 60512-15-1:2008-05
Contact holder in insert Requirements >20 N	Test passed

Resistance of inscriptions

Specification	IEC 60068-2-70:1995-12
Result	Test passed

Polarization and coding

Specification	IEC 60512-13-5:2006-02
Result	Test passed

Visual inspection

Specification	IEC 60512-1-1:2002-02
Result	Test passed

Dimension check

Specification	IEC 60512-1-2:2002-02
Result	Test passed

Environmental and real-life conditions

Vibration test

Specification	IEC 60068-2-6:2007-12
Frequency	10 - 150 - 10 Hz
Sweep speed	1 octave/min
Amplitude	0.35 mm (10 Hz ... 60.1 Hz)
Sweep speed	5g (60.1 Hz ... 150 Hz)
Test duration per axis	2.5 h

PTSM 0,5/ 2-PL-2,5 WH - Printed-circuit board connector



1709457

<https://www.phoenixcontact.com/in/products/1709457>

Durability test

Specification	IEC 60512-9-1:2010-03
Impulse withstand voltage at sea level	2.95 kV
Contact resistance R ₁	3 mΩ
Contact resistance R ₂	4 mΩ
Insertion/withdrawal cycles	10

Climatic test

Specification	ISO 6988:1985-02
Corrosive stress	0.2 dm ³ SO ₂ on 300 dm ³ /40 °C/1 cycle
Thermal stress	100 °C/168 h
Power-frequency withstand voltage	1.39 kV

Shocks

Specification	IEC 60068-2-27:2008-02
Pulse shape	Semi-sinusoidal
Acceleration	30g
Shock duration	18 ms
Test directions	X-, Y- and Z-axis (pos. and neg.)

Ambient conditions

Ambient temperature (operation)	-40 °C ... 100 °C (dependent on the derating curve)
Ambient temperature (storage/transport)	-40 °C ... 70 °C
Relative humidity (storage/transport)	30 % ... 70 %
Ambient temperature (assembly)	-5 °C ... 100 °C

Electrical tests

Thermal test | Test group C

Specification	IEC 60512-5-1:2002-02
Tested number of positions	8

Insulation resistance

Specification	IEC 60512-3-1:2002-02
Insulation resistance, neighboring positions	> 5 MΩ

Temperature cycles

Specification	IEC 60999-1:1999-11
Result	Test passed

Air clearances and creepage distances |

Specification	IEC 60664-1:2007-04
Insulating material group	I
Comparative tracking index (IEC 60112)	CTI 600
Rated insulation voltage (III/3)	100 V
Rated surge voltage (III/3)	2.5 kV
minimum clearance value - non-homogenous field (III/3)	1.5 mm

PTSM 0,5/ 2-PL-2,5 WH - Printed-circuit board connector



1709457

<https://www.phoenixcontact.com/in/products/1709457>

minimum creepage distance (III/3)	1.8 mm
Rated insulation voltage (III/2)	160 V
Rated surge voltage (III/2)	2.5 kV
minimum clearance value - non-homogenous field (III/2)	1.5 mm
minimum creepage distance (III/2)	1.5 mm
Rated insulation voltage (II/2)	320 V
Rated surge voltage (II/2)	2.5 kV
minimum clearance value - non-homogenous field (II/2)	1.5 mm
minimum creepage distance (II/2)	1.6 mm

Packaging specifications

Type of packaging	packed in cardboard
Outer packaging type	Carton

PTSM 0,5/ 2-PL-2,5 WH - Printed-circuit board connector



1709457

<https://www.phoenixcontact.com/in/products/1709457>

Drawings

Diagram

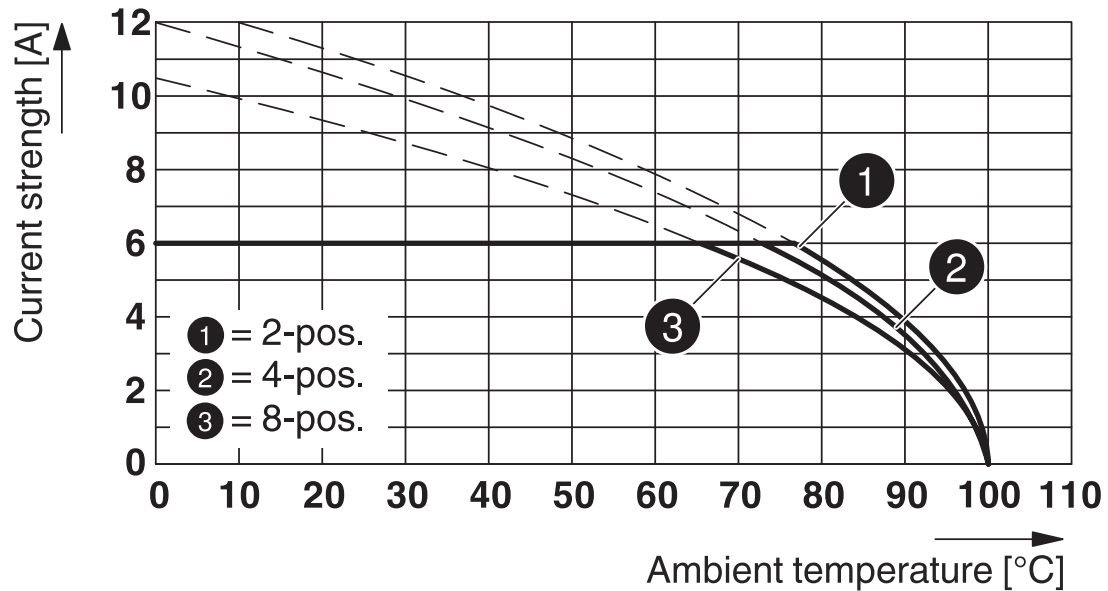

Type: PTSM 0,5/...-PL-2,5 ... with PTSM 0,5/...-HH-2,5-SMD... R...

Dimensional drawing

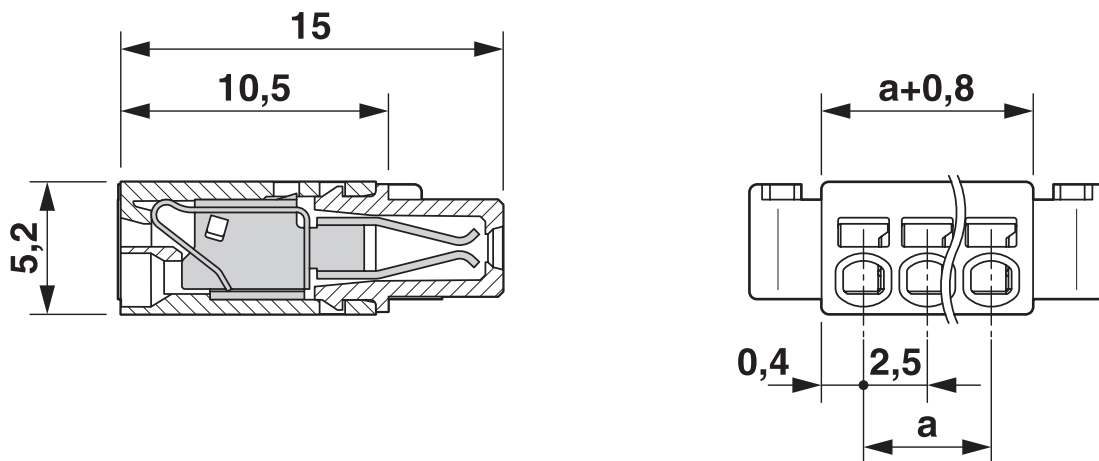

PTSM 0,5/ 2-PL-2,5 WH - Printed-circuit board connector



1709457

<https://www.phoenixcontact.com/in/products/1709457>

Approvals

 UL Recognized Approval ID: E118976-20130619				
	Nominal Voltage U_N	Nominal Current I_N	Cross Section AWG	Cross Section mm^2
	150 V	5 A	26 - 18	-

 EAC Approval ID: B.01687				
--	--	--	--	--

 cULus Recognized Approval ID: E60425-20101209				
	Nominal Voltage U_N	Nominal Current I_N	Cross Section AWG	Cross Section mm^2
	150 V	5 A	26 - 20	-

 VDE Zeichengenehmigung Approval ID: 40048497				
	Nominal Voltage U_N	Nominal Current I_N	Cross Section AWG	Cross Section mm^2
	160 V	6 A	-	0.14 - 0.5

PTSM 0,5/ 2-PL-2,5 WH - Printed-circuit board connector



1709457

<https://www.phoenixcontact.com/in/products/1709457>

Classifications

ECLASS

ECLASS-11.0	27460202
ECLASS-12.0	27460202
ECLASS-13.0	27460202

ETIM

ETIM 8.0	EC002638
----------	----------

UNSPSC

UNSPSC 21.0	39121400
-------------	----------

PTSM 0,5/ 2-PL-2,5 WH - Printed-circuit board connector



1709457

<https://www.phoenixcontact.com/in/products/1709457>

Environmental Product Compliance

China RoHS	Environmentally friendly use period: unlimited = EFUP-e
	No hazardous substances above threshold values

PTSM 0,5/ 2-PL-2,5 WH - Printed-circuit board connector



1709457

<https://www.phoenixcontact.com/in/products/1709457>

Accessories

SZS 0,4X2,0 - Screwdriver

1205202

<https://www.phoenixcontact.com/in/products/1205202>



Micro screwdriver, bladed, size: 0.4 x 2.0 x 60 mm, 2-component grip, with non-slip grip and twist cap

AI 0,25- 6 BU - Ferrule

3203040

<https://www.phoenixcontact.com/in/products/3203040>



Ferrule, sleeve length: 6 mm, length: 10.5 mm, color: blue

PTSM 0,5/ 2-PL-2,5 WH - Printed-circuit board connector

1709457

<https://www.phoenixcontact.com/in/products/1709457>

AI 0,25- 6 YE - Ferrule

3203024

<https://www.phoenixcontact.com/in/products/3203024>



Ferrule, sleeve length: 6 mm, length: 10.5 mm, color: yellow

AI 0,34- 6 TQ - Ferrule

3203053

<https://www.phoenixcontact.com/in/products/3203053>



Ferrule, sleeve length: 6 mm, length: 10.5 mm, color: turquoise

PTSM 0,5/ 2-PL-2,5 WH - Printed-circuit board connector



1709457

<https://www.phoenixcontact.com/in/products/1709457>

PTSM 0,5/ 2-PI-2,5 WH - Printed-circuit board connector

1709450

<https://www.phoenixcontact.com/in/products/1709450>



PCB connector, nominal cross section: 0.5 mm², color: white, nominal current: 6 A, rated voltage (III/2): 160 V, contact surface: Tin, type of contact: Pin, number of potentials: 2, number of rows: 1, number of positions: 2, number of connections: 2, product range: PTSM 0,5/...-PI WH, pitch: 2.5 mm, connection method: Push-in spring connection, conductor/PCB connection direction: 0 °, plug-in system: COMBICON PTSM, locking: without, mounting: without, type of packaging: packed in cardboard

PTSM 0,5/ 2-HH0-2,5-SMD WH R32 - PCB header

1814919

<https://www.phoenixcontact.com/in/products/1814919>

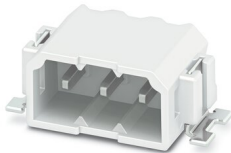

PCB headers, nominal cross section: 0.5 mm², color: signal white, nominal current: 6 A, rated voltage (III/2): 160 V, contact surface: Tin, type of contact: Pin, number of potentials: 2, number of rows: 1, number of positions: 2, number of connections: 2, product range: PTSM 0,5/...-HH-SMD WH, pitch: 2.5 mm, mounting: SMD soldering, pin layout: Linear pinning, number of solder pins per potential: 1, plug-in system: COMBICON PTSM, Pin connector pattern alignment: Standard, locking: without, mounting: without, type of packaging: 32 mm wide tape

PTSM 0,5/ 2-PL-2,5 WH - Printed-circuit board connector



1709457

<https://www.phoenixcontact.com/in/products/1709457>

PTSM 0,5/ 2-HV-2,5-SMD WH R24 - PCB header

1778696

<https://www.phoenixcontact.com/in/products/1778696>



PCB headers, nominal cross section: 0.5 mm², color: signal white, nominal current: 6 A, rated voltage (III/2): 160 V, contact surface: Tin, type of contact: Pin, number of potentials: 2, number of rows: 1, number of positions: 2, number of connections: 2, product range: PTSM 0,5/..-HV-SMD WH, pitch: 2.5 mm, mounting: SMD soldering, pin layout: Linear pinning, solder pin [P]: 2 mm, number of solder pins per potential: 1, plug-in system: COMBICON PTSM, Pin connector pattern alignment: Standard, locking: without, mounting: without, type of packaging: 24 mm wide tape, Article with anti-rotation pin

PTSM 0,5/ 2-HV0-2,5-SMD WH R24 - PCB header

1839198

<https://www.phoenixcontact.com/in/products/1839198>



PCB headers, nominal cross section: 0.5 mm², color: signal white, nominal current: 6 A, rated voltage (III/2): 160 V, contact surface: Tin, type of contact: Pin, number of potentials: 2, number of rows: 1, number of positions: 2, number of connections: 2, product range: PTSM 0,5/..-HV-SMD WH, pitch: 2.5 mm, mounting: SMD soldering, pin layout: Linear pinning, number of solder pins per potential: 1, plug-in system: COMBICON PTSM, Pin connector pattern alignment: Standard, locking: without, mounting: without, type of packaging: 24 mm wide tape

PTSM 0,5/ 2-PL-2,5 WH - Printed-circuit board connector



1709457

<https://www.phoenixcontact.com/in/products/1709457>

PTSM 0,5/ 2-HTB-2,5-SMD WH R24 - PCB header

1830126

<https://www.phoenixcontact.com/in/products/1830126>

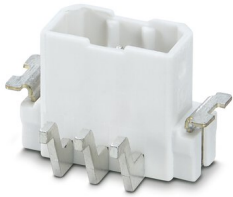

PCB headers, nominal cross section: 0.5 mm², color: signal white, nominal current: 6 A, rated voltage (III/2): 160 V, contact surface: Tin, type of contact: Pin, number of potentials: 2, number of rows: 1, number of positions: 2, number of connections: 2, product range: PTSM 0,5/..-HTB-SMD WH, pitch: 2.5 mm, mounting: SMD soldering, pin layout: Linear pinning, number of solder pins per potential: 1, plug-in system: COMBICON PTSM, Pin connector pattern alignment: Standard, locking: without, mounting: without, type of packaging: 24 mm wide tape

PTSM 0,5/ 2-HH-2,5-THR WH R16 - PCB header

1814841

<https://www.phoenixcontact.com/in/products/1814841>

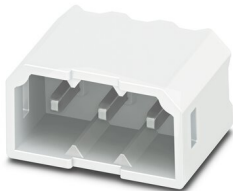

PCB headers, nominal cross section: 0.5 mm², color: signal white, nominal current: 6 A, rated voltage (III/2): 160 V, contact surface: Tin, type of contact: Pin, number of potentials: 2, number of rows: 1, number of positions: 2, number of connections: 2, product range: PTSM 0,5/..-HH-THR WH, pitch: 2.5 mm, mounting: THR soldering, pin layout: Linear pinning, solder pin [P]: 2.1 mm, number of solder pins per potential: 1, plug-in system: COMBICON PTSM, Pin connector pattern alignment: Standard, locking: without, mounting: without, type of packaging: 16 mm wide tape

PTSM 0,5/ 2-PL-2,5 WH - Printed-circuit board connector



1709457

<https://www.phoenixcontact.com/in/products/1709457>

PTSM 0,5/ 2-HV-2,5-THR WH R32 - PCB header

1815264

<https://www.phoenixcontact.com/in/products/1815264>

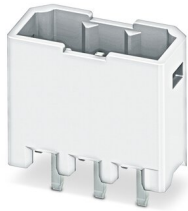

PCB headers, nominal cross section: 0.5 mm², color: signal white, nominal current: 6 A, rated voltage (III/2): 160 V, contact surface: Tin, type of contact: Pin, number of potentials: 2, number of rows: 1, number of positions: 2, number of connections: 2, product range: PTSM 0,5/..-HV-THR WH, pitch: 2.5 mm, mounting: THR soldering, pin layout: Linear pinning, solder pin [P]: 2 mm, number of solder pins per potential: 1, plug-in system: COMBICON PTSM, Pin connector pattern alignment: Standard, locking: without, mounting: without, type of packaging: 32 mm wide tape

PTSM 0,5/ 2-HH-2,5-SMD WH R32 - PCB header

1708004

<https://www.phoenixcontact.com/in/products/1708004>

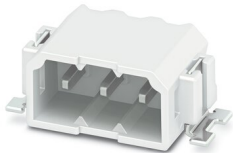

PCB headers, nominal cross section: 0.5 mm², color: signal white, nominal current: 6 A, rated voltage (III/2): 160 V, contact surface: Tin, type of contact: Pin, number of potentials: 2, number of rows: 1, number of positions: 2, number of connections: 2, product range: PTSM 0,5/..-HH-SMD WH, pitch: 2.5 mm, mounting: SMD soldering, pin layout: Linear pinning, solder pin [P]: 2 mm, number of solder pins per potential: 1, plug-in system: COMBICON PTSM, Pin connector pattern alignment: Standard, locking: without, mounting: without, type of packaging: 32 mm wide tape, Article with anti-rotation pin

PTSM 0,5/ 2-PL-2,5 WH - Printed-circuit board connector



1709457

<https://www.phoenixcontact.com/in/products/1709457>

SAMPLE PTSM 0,5 PI/PL-2 SET - Connector set

1714622

<https://www.phoenixcontact.com/in/products/1714622>



Sample set, Connector set, product range: SET

Phoenix Contact 2023 © - all rights reserved

<https://www.phoenixcontact.com>

PHOENIX CONTACT (I) Pvt. Ltd.

A-58/2, Okhla Industrial Area, Phase - II, New Delhi-110 020

+91.1275.71420

info@phoenixcontact.co.in