

# MVSTBW 2,5/ 2-STF-5,08 - PCB connector



1834903

<https://www.phoenixcontact.com/in/products/1834903>

Please be informed that the data shown in this PDF document is generated from our Online Catalog. Please find the complete data in the user documentation. Our General Terms of Use for Downloads are valid.

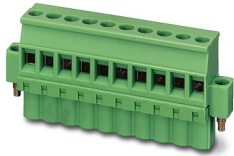

PCB connector, nominal cross section: 2.5 mm<sup>2</sup>, color: green, nominal current: 12 A, rated voltage (III/2): 320 V, contact surface: Tin, type of contact: Socket, number of potentials: 2, number of rows: 1, number of positions: 2, number of connections: 2, product range: MVSTBW 2,5/...-STF, pitch: 5.08 mm, connection method: Screw connection with tension sleeve, screw head form: L Slotted, conductor/PCB connection direction: -90 °, locking clip: - Locking clip, plug-in system: COMBICON MSTB 2,5, locking: Screw locking, mounting: Screw flange, type of packaging: packed in cardboard

## Your advantages

- Well-known connection principle allows worldwide use
- Low temperature rise, thanks to maximum contact force
- Allows connection of two conductors
- Screwable flange for superior mechanical stability

## Commercial Data

|                                      |                     |
|--------------------------------------|---------------------|
| Item number                          | 1834903             |
| Packing unit                         | 50 pc               |
| Minimum order quantity               | 50 pc               |
| Sales Key                            | AAC                 |
| Product Key                          | AACAKI              |
| Catalog Page                         | Page 267 (C-1-2013) |
| GTIN                                 | 4017918102166       |
| Weight per Piece (including packing) | 5.628 g             |
| Weight per Piece (excluding packing) | 5.105 g             |
| Customs tariff number                | 85366990            |
| Country of origin                    | DE                  |

# MVSTBW 2,5/ 2-STF-5,08 - PCB connector



1834903

<https://www.phoenixcontact.com/in/products/1834903>

## Technical Data

### Product properties

|                       |                       |
|-----------------------|-----------------------|
| Type                  | Standard              |
| Product line          | COMBICON Connectors M |
| Product type          | PCB plug              |
| Product family        | MVSTBW 2,5/..-STF     |
| Number of positions   | 2                     |
| Pitch                 | 5.08 mm               |
| Number of connections | 2                     |
| Number of rows        | 1                     |
| Mounting flange       | Screw flange          |
| Number of potentials  | 2                     |

### Electrical properties

|                             |        |
|-----------------------------|--------|
| Nominal current $I_N$       | 12 A   |
| Nominal voltage $U_N$       | 320 V  |
| Degree of pollution         | 3      |
| Contact resistance          | 2.2 mΩ |
| Rated voltage (III/3)       | 250 V  |
| Rated surge voltage (III/3) | 4 kV   |
| Rated voltage (III/2)       | 320 V  |
| Rated surge voltage (III/2) | 4 kV   |
| Rated voltage (II/2)        | 630 V  |
| Rated surge voltage (II/2)  | 4 kV   |

### Connection data

#### Connection technology

|                       |                     |
|-----------------------|---------------------|
| Connector system      | COMBICON MSTB 2,5   |
| Nominal cross section | 2.5 mm <sup>2</sup> |
| Type of contact       | Socket              |

#### Interlock

|                   |               |
|-------------------|---------------|
| Locking type      | Screw locking |
| Mounting flange   | Screw flange  |
| Tightening torque | 0.3 Nm        |

#### Conductor connection

|  |  |
|--|--|
| Connection method  | Screw connection with tension sleeve         |
| Conductor/PCB connection direction                             | -90 °  |
| Conductor cross section rigid                                  | 0.2 mm <sup>2</sup> ... 2.5 mm <sup>2</sup>  |
| Conductor cross section flexible                               | 0.2 mm <sup>2</sup> ... 2.5 mm <sup>2</sup>  |
| Conductor cross section AWG                                    | 24 ... 12                                    |
| Conductor cross section flexible, with ferrule without plastic | 0.25 mm <sup>2</sup> ... 2.5 mm <sup>2</sup> |

# MVSTBW 2,5/ 2-STF-5,08 - PCB connector

1834903

<https://www.phoenixcontact.com/in/products/1834903>

|   |  |
|---|--|
| sleeve  |  |
| Conductor cross section, flexible, with ferrule, with plastic sleeve                      | 0.25 mm <sup>2</sup> ... 2.5 mm <sup>2</sup> |
| 2 conductors with same cross section, solid   | 0.2 mm <sup>2</sup> ... 1 mm <sup>2</sup>    |
| 2 conductors with same cross section, flexible  | 0.2 mm <sup>2</sup> ... 1.5 mm <sup>2</sup>  |
| 2 conductors with same cross section, flexible, with ferrule without plastic sleeve       | 0.25 mm <sup>2</sup> ... 1 mm <sup>2</sup>   |
| 2 conductors with the same cross section, flexible, with TWIN ferrule with plastic sleeve | 0.5 mm <sup>2</sup> ... 1.5 mm <sup>2</sup>  |
| Cylindrical gauge a x b / diameter  | 2.8 mm x 2.0 mm / 2.4 mm                     |
| Stripping length  | 7 mm   |
| Tightening torque   | 0.5 Nm ... 0.6 Nm                            |

## Material specifications

### Material data - contact

|  |  |
|--|--|
| Note                                     | WEEE/RoHS-compliant, free of whiskers according to IEC 60068-2-82/JEDEC JESD 201 |
| Contact material                         | Cu alloy   |
| Surface characteristics                  | hot-dip tin-plated   |
| Metal surface terminal point (top layer) | Tin (4 - 8 µm Sn)  |
| Metal surface contact area (top layer)   | Tin (4 - 8 µm Sn)  |

### Material data - housing

|   |              |
|---|--------------|
| Color (Housing)   | green (6021) |
| Insulating material   | PA           |
| Insulating material group   | I            |
| CTI according to IEC 60112  | 600          |
| Flammability rating according to UL 94                            | V0           |
| Glow wire flammability index GWFI according to EN 60695-2-12      | 850          |
| Glow wire ignition temperature GWIT according to EN 60695-2-13    | 775          |
| Temperature for the ball pressure test according to EN 60695-10-2 | 125 °C       |

### Material data – actuating element

|           |     |
|-----------|-----|
| Color ( ) | ( ) |
|-----------|-----|

## Dimensions

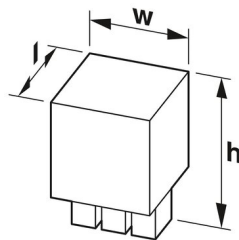
|                     |  |
|---------------------|--|
| Dimensional drawing |  |
| Pitch               | 5.08 mm  |

# MVSTBW 2,5/ 2-STF-5,08 - PCB connector



1834903

<https://www.phoenixcontact.com/in/products/1834903>

|            |          |
|------------|----------|
| Width [w]  | 20.32 mm |
| Height [h] | 26 mm    |
| Length [l] | 12.6 mm  |

## Mounting

|                       |             |
|-----------------------|-------------|
| Drive form screw head | Slotted (L) |
| Drive form screw head | Slotted (L) |

## Flange

|                   |        |
|-------------------|--------|
| Tightening torque | 0.3 Nm |
|-------------------|--------|

## Notes

|                    |  |
|--------------------|--|
| Notes on operation | In accordance with IEC 61984, COMBICON connectors have no switching power (COC). During designated use, they must not be plugged in or disconnected when carrying voltage or under load. |
|--------------------|--|

## Mechanical tests

### Test for conductor damage and slackening

|               |                     |
|---------------|---------------------|
| Specification | IEC 60999-1:1999-11 |
| Result        | Test passed         |

### Pull-out test

|   |   |
|---|---|
| Specification   | IEC 60999-1:1999-11                     |
| Conductor cross section/conductor type/tractive force setpoint/actual value | 0.2 mm <sup>2</sup> / solid / > 10 N    |
|   | 0.2 mm <sup>2</sup> / flexible / > 10 N |
|   | 2.5 mm <sup>2</sup> / solid / > 50 N    |
|   | 2.5 mm <sup>2</sup> / flexible / > 50 N |

### Insertion and withdrawal forces

|                                     |             |
|-------------------------------------|-------------|
| Result                              | Test passed |
| No. of cycles                       | 25          |
| Insertion strength per pos. approx. | 8 N         |
| Withdraw strength per pos. approx.  | 6 N         |

### Torque test

|               |                     |
|---------------|---------------------|
| Specification | IEC 60999-1:1999-11 |
|---------------|---------------------|

### Contact holder in insert

|   |                        |
|---|------------------------|
| Specification                               | IEC 60512-15-1:2008-05 |
| Contact holder in insert Requirements >20 N | Test passed            |

### Resistance of inscriptions

|               |                        |
|---------------|------------------------|
| Specification | IEC 60068-2-70:1995-12 |
| Result        | Test passed            |

### Polarization and coding

|               |                        |
|---------------|------------------------|
| Specification | IEC 60512-13-5:2006-02 |
|---------------|------------------------|

# MVSTBW 2,5/ 2-STF-5,08 - PCB connector



1834903

<https://www.phoenixcontact.com/in/products/1834903>

|        |             |
|--------|-------------|
| Result | Test passed |
|--------|-------------|

## Visual inspection

|               |                       |
|---------------|-----------------------|
| Specification | IEC 60512-1-1:2002-02 |
| Result        | Test passed           |

## Dimension check

|               |                       |
|---------------|-----------------------|
| Specification | IEC 60512-1-2:2002-02 |
| Result        | Test passed           |

## Environmental and real-life conditions

### Vibration test

|                        |                             |
|------------------------|-----------------------------|
| Specification          | IEC 60068-2-6:2007-12       |
| Frequency              | 10 - 150 - 10 Hz            |
| Sweep speed            | 1 octave/min                |
| Amplitude              | 0.35 mm (10 Hz ... 60.1 Hz) |
| Sweep speed            | 5g (60.1 Hz ... 150 Hz)     |
| Test duration per axis | 2.5 h                       |

### Durability test

|  |                       |
|--|-----------------------|
| Specification                                | IEC 60512-9-1:2010-03 |
| Impulse withstand voltage at sea level       | 4.8 kV                |
| Contact resistance $R_1$                     | 2.2 m $\Omega$        |
| Contact resistance $R_2$                     | 2.3 m $\Omega$        |
| Insertion/withdrawal cycles                  | 25                    |
| Insulation resistance, neighboring positions | > 5 M $\Omega$        |

### Climatic test

|                                   |   |
|-----------------------------------|---|
| Specification                     | ISO 6988:1985-02  |
| Corrosive stress                  | 0.2 dm <sup>3</sup> SO <sub>2</sub> on 300 dm <sup>3</sup> /40 °C/1 cycle |
| Thermal stress                    | 100 °C/168 h  |
| Power-frequency withstand voltage | 2.21 kV   |

### Ambient conditions

|   |   |
|---|---|
| Ambient temperature (operation)         | -40 °C ... 100 °C (dependent on the derating curve) |
| Ambient temperature (storage/transport) | -40 °C ... 70 °C                                    |
| Relative humidity (storage/transport)   | 30 % ... 70 %                                       |
| Ambient temperature (assembly)          | -5 °C ... 100 °C                                    |

## Electrical tests

### Thermal test | Test group C

|                            |                       |
|----------------------------|-----------------------|
| Specification              | IEC 60512-5-1:2002-02 |
| Tested number of positions | 12                    |

### Insulation resistance

|               |                       |
|---------------|-----------------------|
| Specification | IEC 60512-3-1:2002-02 |
|---------------|-----------------------|

# MVSTBW 2,5/ 2-STF-5,08 - PCB connector



1834903

<https://www.phoenixcontact.com/in/products/1834903>

|  |        |
|--|--------|
| Insulation resistance, neighboring positions | > 5 MΩ |
|--|--------|

## Air clearances and creepage distances |

|  |                     |
|--|---------------------|
| Specification  | IEC 60664-1:2007-04 |
| Insulating material group                              | I                   |
| Comparative tracking index (IEC 60112)                 | CTI 600             |
| Rated insulation voltage (III/3)                       | 250 V               |
| Rated surge voltage (III/3)                            | 4 kV                |
| minimum clearance value - non-homogenous field (III/3) | 3 mm                |
| minimum creepage distance (III/3)                      | 3.2 mm              |
| Rated insulation voltage (III/2)                       | 320 V               |
| Rated surge voltage (III/2)                            | 4 kV                |
| minimum clearance value - non-homogenous field (III/2) | 3 mm                |
| minimum creepage distance (III/2)                      | 3 mm                |
| Rated insulation voltage (II/2)                        | 630 V               |
| Rated surge voltage (II/2)                             | 4 kV                |
| minimum clearance value - non-homogenous field (II/2)  | 3 mm                |
| minimum creepage distance (II/2)                       | 3.2 mm              |

## Packaging specifications

|                   |                     |
|-------------------|---------------------|
| Type of packaging | packed in cardboard |
|-------------------|---------------------|

## Drawings

Diagram

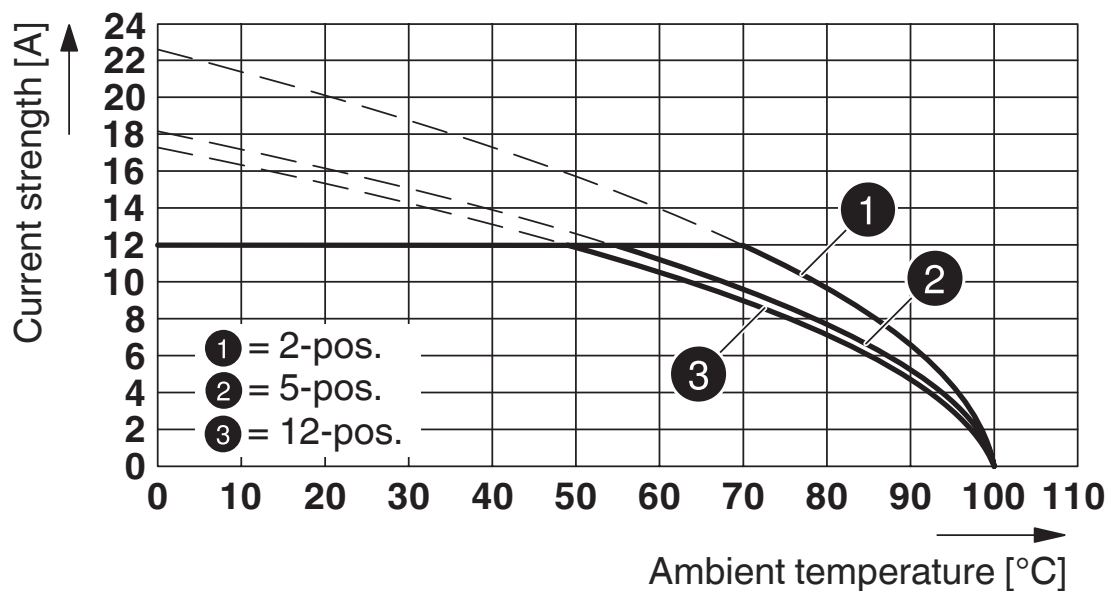

Type: MVSTB(R/W) 2,5/...-STF-5,08 with CC 2,5/...-GF-5,08 P26THR

Diagram

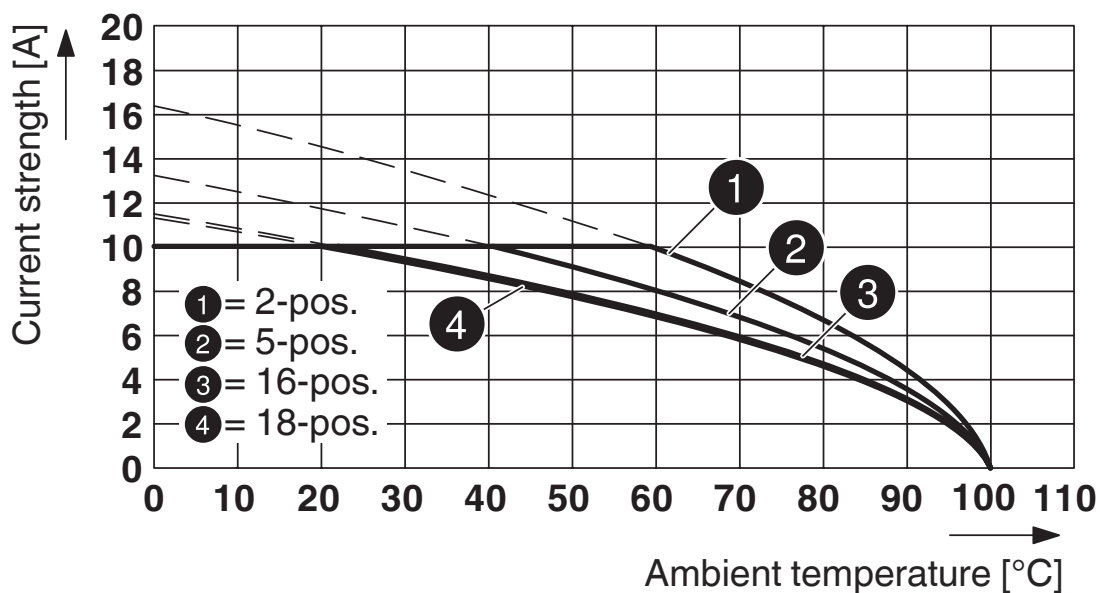

Type: MVSTB(R/W) 2,5/...-STF-5,08 with MDSTBV 2,5/...-GF-5,08

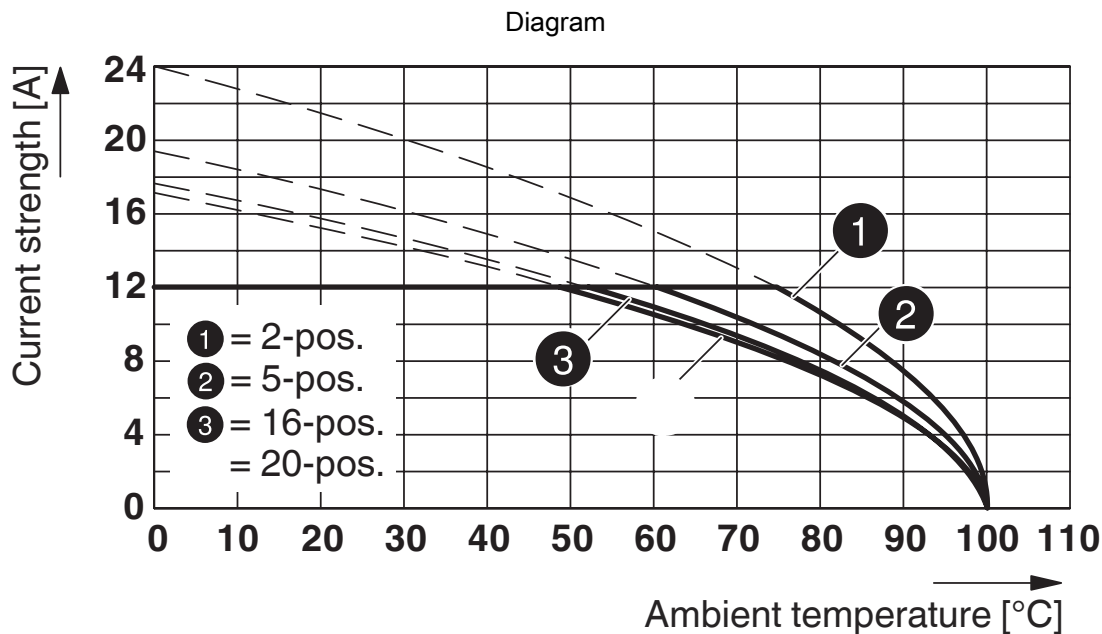

Type: MVSTBW 2,5/...-STF-5,08 with MVSTBU 2,5/...-GFB-5,08

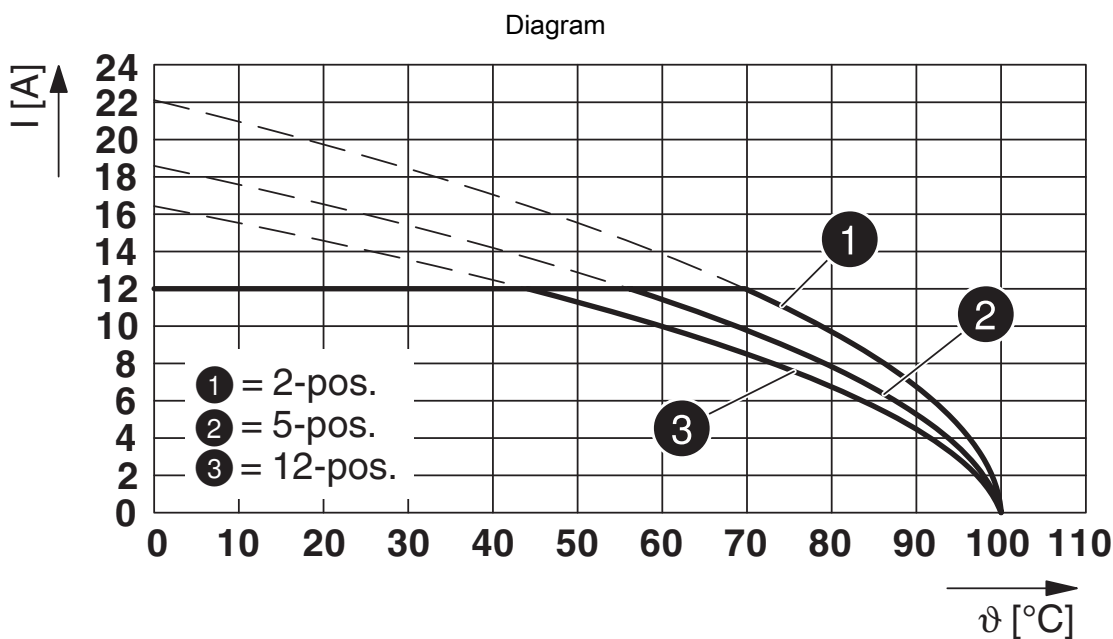

Type: MVSTB(R/W) 2,5/...-STF-5,08 with CCV 2,5/...-GF-5,08-LR P...THR



1834903

<https://www.phoenixcontact.com/in/products/1834903>

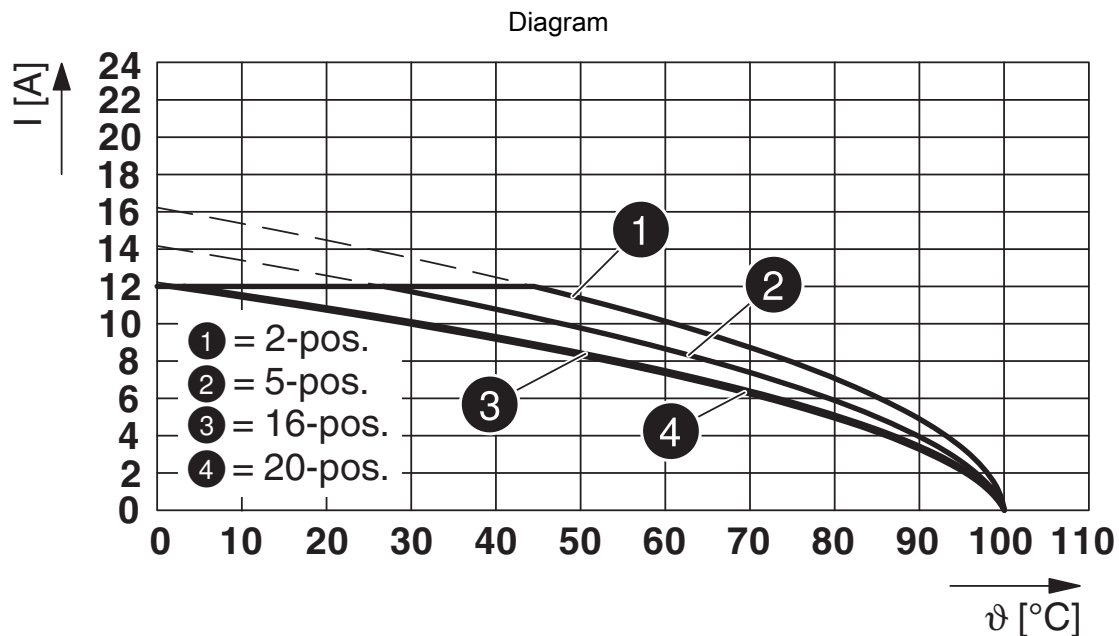

Type: MVSTB(R/W) 2,5/...-STF-5,08 with MSTBV 2,5/...-GF-5,08

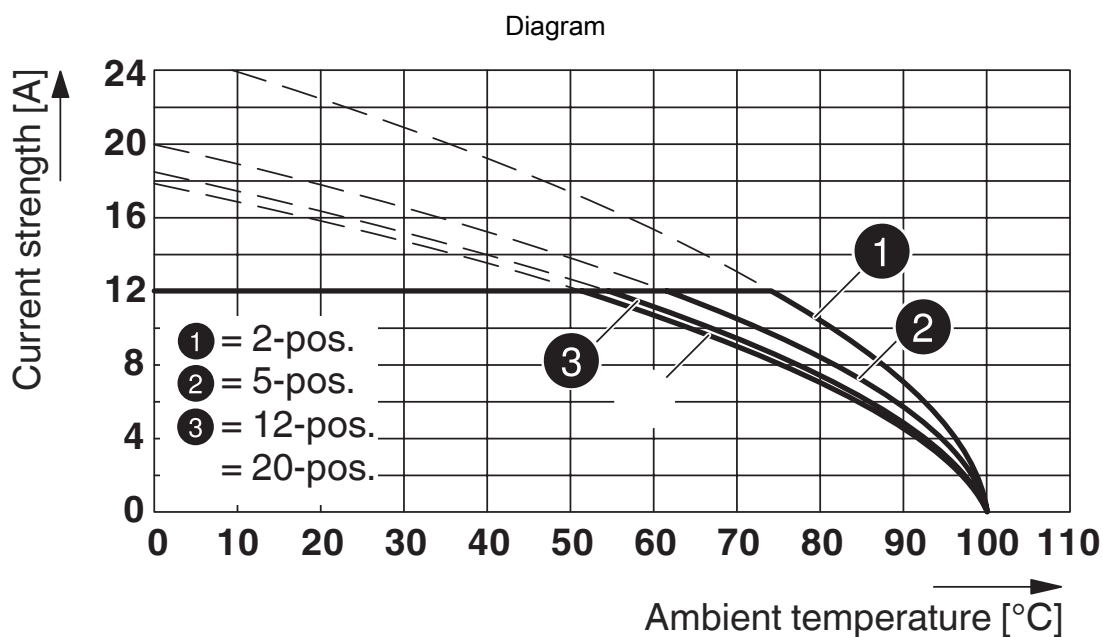

Type: MVSTBW 2,5/...-STF-5,0 with UMSTBVK 2,5/...-GF-5,08

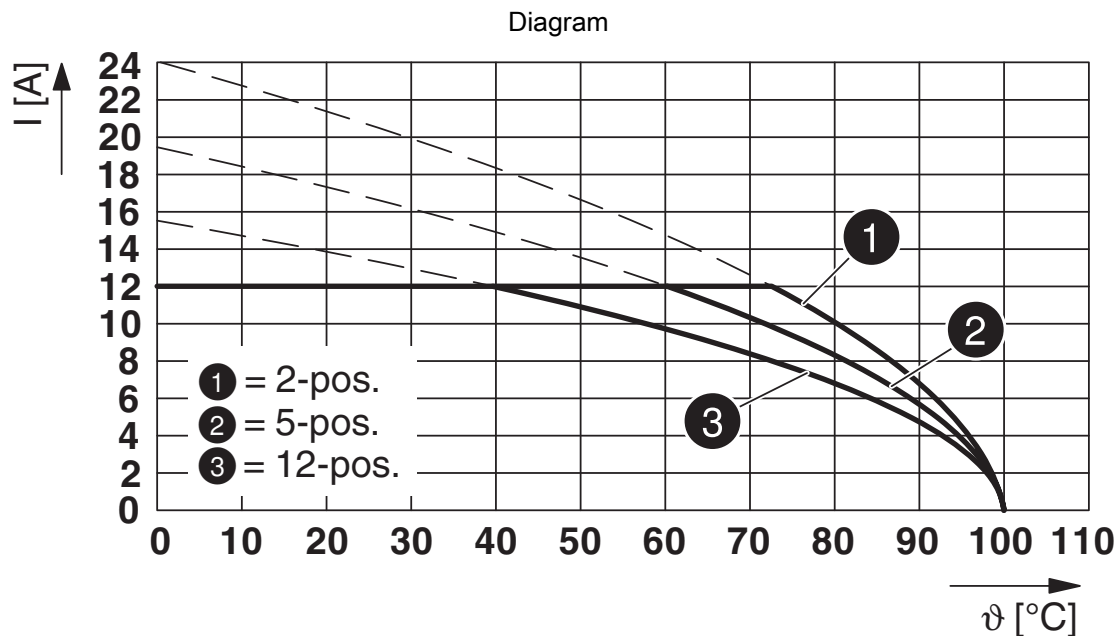

Type: MVSTB(R/W) 2,5/...-STF-5,08 with CC 2,5/...-GF-5,08-LR P...THR

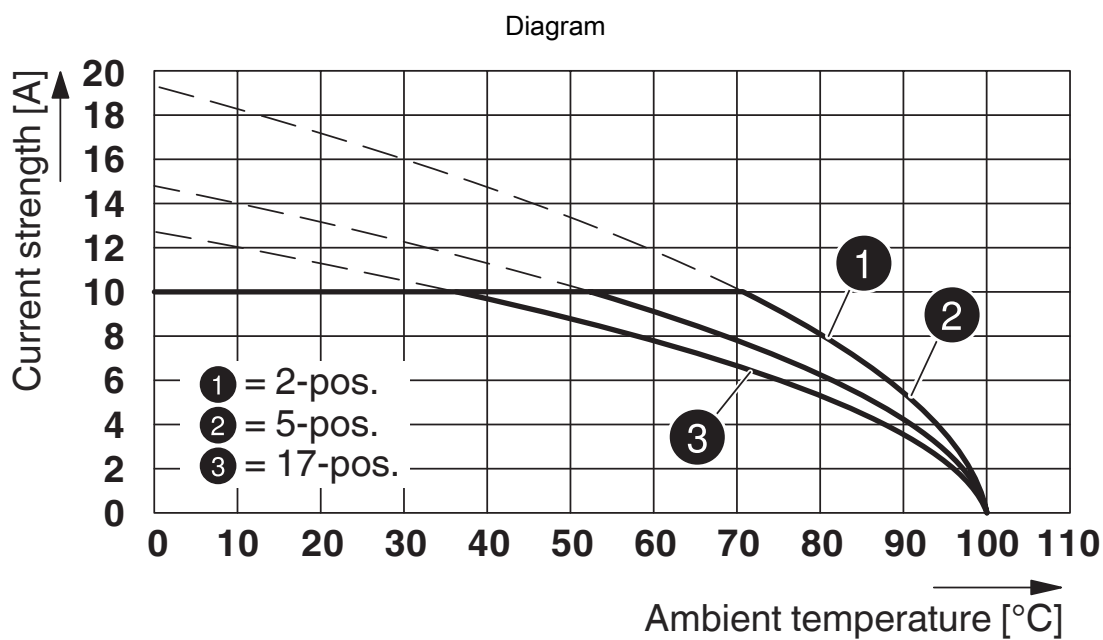

Type: MVSTB(R/W) 2,5/...-STF-5,08 with MDSTB 2,5/...-GF-5,08

# MVSTBW 2,5/ 2-STF-5,08 - PCB connector



1834903

<https://www.phoenixcontact.com/in/products/1834903>

## Approvals

|  <b>CSA</b><br>Approval ID: 13631 |                       |                       |                   |                             |
|--|-----------------------|-----------------------|-------------------|-----------------------------|
|  | Nominal Voltage $U_N$ | Nominal Current $I_N$ | Cross Section AWG | Cross Section $\text{mm}^2$ |
|  | 300 V                 | 10 A                  | 28 - 12           | -                           |
|  | 300 V                 | 10 A                  | 28 - 12           | -                           |

|  <b>IECEE CB Scheme</b><br>Approval ID: DE1-60988-B1B2 |                       |                       |                   |                             |
|---|-----------------------|-----------------------|-------------------|-----------------------------|
|   | Nominal Voltage $U_N$ | Nominal Current $I_N$ | Cross Section AWG | Cross Section $\text{mm}^2$ |
|   | 250 V                 | 12 A                  | -                 | 0.2 - 2.5                   |

|  <b>EAC</b><br>Approval ID: B.01687 |  |  |  |  |
|--|--|--|--|--|
|--|--|--|--|--|

|  <b>cULus Recognized</b><br>Approval ID: E60425-19931011 |                       |                       |                   |                             |
|---|-----------------------|-----------------------|-------------------|-----------------------------|
|   | Nominal Voltage $U_N$ | Nominal Current $I_N$ | Cross Section AWG | Cross Section $\text{mm}^2$ |
|   | 300 V                 | 15 A                  | 30 - 12           | -                           |
|   | 300 V                 | 10 A                  | 30 - 12           | -                           |

|  <b>VDE Zeichengenehmigung</b><br>Approval ID: 40050694 |                       |                       |                   |                             |
|--|-----------------------|-----------------------|-------------------|-----------------------------|
|  | Nominal Voltage $U_N$ | Nominal Current $I_N$ | Cross Section AWG | Cross Section $\text{mm}^2$ |
|  | 250 V                 | 12 A                  | -                 | 0.2 - 2.5                   |

# MVSTBW 2,5/ 2-STF-5,08 - PCB connector



1834903

<https://www.phoenixcontact.com/in/products/1834903>

## Classifications

### ECLASS

|             |          |
|-------------|----------|
| ECLASS-11.0 | 27460202 |
| ECLASS-12.0 | 27460202 |
| ECLASS-13.0 | 27460202 |

### ETIM

|          |          |
|----------|----------|
| ETIM 8.0 | EC002638 |
|----------|----------|

### UNSPSC

|             |          |
|-------------|----------|
| UNSPSC 21.0 | 39121400 |
|-------------|----------|

# MVSTBW 2,5/ 2-STF-5,08 - PCB connector



1834903

<https://www.phoenixcontact.com/in/products/1834903>

## Environmental Product Compliance

|            |   |
|------------|---|
| China RoHS | Environmentally friendly use period: unlimited = EFUP-e |
|            | No hazardous substances above threshold values          |

# MVSTBW 2,5/ 2-STF-5,08 - PCB connector



1834903

<https://www.phoenixcontact.com/in/products/1834903>

## Accessories

SK 5,08/3,8:UNBEDRUCKT - Marker card

0805412

<https://www.phoenixcontact.com/in/products/0805412>

Marker card, white, unlabeled, can be labeled with: Marker pen, mounting type: adhesive, for terminal block width: 5.08 mm, lettering field size: 5.08 x 3.8 mm



---

SZS 0,6X3,5 - Screwdriver

1205053

<https://www.phoenixcontact.com/in/products/1205053>

Actuation tool, for ST terminal blocks, insulated, also suitable for use as a bladed screwdriver, size: 0.6 x 3.5 x 100 mm, 2-component grip, with non-slip grip



# MVSTBW 2,5/ 2-STF-5,08 - PCB connector

1834903

<https://www.phoenixcontact.com/in/products/1834903>

## CP-MSTB - Coding profile

1734634

<https://www.phoenixcontact.com/in/products/1734634>

Coding profile, is inserted into the slot on the plug or inverted header, red insulating material



---

## MDSTB 2,5/ 2-GFR-5,08 - PCB header

1736768

<https://www.phoenixcontact.com/in/products/1736768>



PCB headers, nominal cross section: 2.5 mm<sup>2</sup>, color: green, nominal current: 10 A, rated voltage (III/2): 320 V, contact surface: Tin, type of contact: Pin, number of potentials: 4, number of rows: 2, number of positions: 2, number of connections: 4, product range: MDSTB 2,5/...-GF, pitch: 5.08 mm, mounting: Wave soldering, pin layout: Linear pinning, solder pin [P]: 3.2 mm, number of solder pins per potential: 1, plug-in system: COMBICON MSTB 2,5, Pin connector pattern alignment: Standard, locking: Screw locking, mounting: Threaded flange, type of packaging: packed in cardboard, Can be aligned! Mounting flange: Item No. 1736771, 1736768. In combination with MVSTB or FKCV plugs, both an MVSTBW (or FKCVW) and an MVSTBR plug (or FKCVR) must be used. Combination with TMSTBP plugs is not possible!

# MVSTBW 2,5/ 2-STF-5,08 - PCB connector

1834903

<https://www.phoenixcontact.com/in/products/1834903>

## MDSTB 2,5/ 2-GFL-5,08 - PCB header

1736771

<https://www.phoenixcontact.com/in/products/1736771>



PCB headers, nominal cross section: 2.5 mm<sup>2</sup>, color: green, nominal current: 10 A, rated voltage (III/2): 320 V, contact surface: Tin, type of contact: Pin, number of potentials: 4, number of rows: 2, number of positions: 2, number of connections: 4, product range: MDSTB 2,5/..-GF, pitch: 5.08 mm, mounting: Wave soldering, pin layout: Linear pinning, solder pin [P]: 3.2 mm, number of solder pins per potential: 1, plug-in system: COMBICON MSTB 2,5, Pin connector pattern alignment: Standard, locking: Screw locking, mounting: Threaded flange, type of packaging: packed in cardboard, Can be aligned! Mounting flange: Item No. 1736771, 1736768. In combination with MVSTB or FKCV plugs, both an MVSTBW (or FKCVW) and an MVSTBR plug (or FKCVR) must be used. Combination with TMSTBP plugs is not possible!

---

## CCV 2,5/ 2-GF-5,08 P26THR - PCB header

1955633

<https://www.phoenixcontact.com/in/products/1955633>



PCB headers, nominal cross section: 2.5 mm<sup>2</sup>, color: black, nominal current: 12 A, rated voltage (III/2): 320 V, contact surface: Tin, type of contact: Pin, number of potentials: 2, number of rows: 1, number of positions: 2, number of connections: 2, product range: CCV 2,5/..-GF, pitch: 5.08 mm, mounting: THR soldering, pin layout: Linear pinning, solder pin [P]: 2.6 mm, number of solder pins per potential: 1, plug-in system: COMBICON MSTB 2,5, Pin connector pattern alignment: Standard, locking: Screw locking, mounting: Threaded flange, type of packaging: packed in cardboard, For user information and design recommendations for through-hole reflow technology, go to: Downloads



# MVSTBW 2,5/ 2-STF-5,08 - PCB connector



1834903

<https://www.phoenixcontact.com/in/products/1834903>

## CCV 2,5/ 2-GF-5,08 P26THRR32 - PCB header

1955743

<https://www.phoenixcontact.com/in/products/1955743>



PCB headers, nominal cross section: 2.5 mm<sup>2</sup>, color: black, nominal current: 12 A, rated voltage (III/2): 320 V, contact surface: Tin, type of contact: Pin, number of potentials: 2, number of rows: 1, number of positions: 2, number of connections: 2, product range: CCV 2,5/..-GF, pitch: 5.08 mm, mounting: THR soldering, pin layout: Linear pinning, solder pin [P]: 2.6 mm, number of solder pins per potential: 1, plug-in system: COMBICON MSTB 2,5, Pin connector pattern alignment: Standard, locking: Screw locking, mounting: Threaded flange, type of packaging: 32 mm wide tape, For user information and design recommendations for through-hole reflow technology, go to: Downloads

---

Phoenix Contact 2023 © - all rights reserved

<https://www.phoenixcontact.com>

PHOENIX CONTACT (I) Pvt. Ltd.

A-58/2, Okhla Industrial Area, Phase - II, New Delhi-110 020

+91.1275.71420

[info@phoenixcontact.co.in](mailto:info@phoenixcontact.co.in)