

# PLC-RSC- 24DC/21HC - Relay Module



2967620

<https://www.phoenixcontact.com/in/products/2967620>

Please be informed that the data shown in this PDF document is generated from our Online Catalog. Please find the complete data in the user documentation. Our General Terms of Use for Downloads are valid.



PLC-INTERFACE for high continuous currents, consisting of PLC-BSC.../21 HC basic terminal block with screw connection and plug-in miniature relay, for mounting on NS 35/7,5 DIN rail, limiting continuous current up to 10 A, 1 changeover contact, input voltage 24 V DC

## Your advantages

- All common input voltages of 12 V DC ... 230 V AC
- Efficient connection to system cabling using V8 adapter
- Long electrical service life thanks to 16 A relay
- Safe isolation according to DIN EN 50178 between coil and contact
- Max. continuous current of 10 A
- Functional plug-in bridges

## Commercial Data

Item number	2967620
Packing unit	10 pc
Minimum order quantity	10 pc
Sales Key	CK6
Product Key	CK621A
Catalog Page	Page 384 (C-5-2019)
GTIN	4017918171643
Weight per Piece (including packing)	77.3 g
Weight per Piece (excluding packing)	74.212 g
Customs tariff number	85364900
Country of origin	IN

# PLC-RSC- 24DC/21HC - Relay Module



2967620

<https://www.phoenixcontact.com/in/products/2967620>

## Set consists of

### PLC-BSC- 24DC/21HC - Relay base

2967772

<https://www.phoenixcontact.com/in/products/2967772>



14 mm PLC basic terminal block for high continuous currents with screw connection, without relay or solid-state relay, for mounting on DIN rail NS 35/7,5, 1 changeover contact, input voltage 24 V DC

---

### REL-MR- 24DC/21HC - Single relay

2961312

<https://www.phoenixcontact.com/in/products/2961312>



Plug-in miniature power relay, with power contact for high continuous currents, 1 changeover contact, input voltage 24 V DC

# PLC-RSC- 24DC/21HC - Relay Module



2967620

<https://www.phoenixcontact.com/in/products/2967620>

## Technical Data

### Product properties

Product type	Relay Module
Product family	PLC-INTERFACE
Application	High continuous currents
Operating mode	100% operating factor
Mechanical service life	3x 10 <sup>7</sup> cycles

### Insulation characteristics

Insulation	Safe isolation, reinforced insulation
------------	---------------------------------------

### Insulation characteristics

Insulation	Safe isolation, reinforced insulation
Overvoltage category	III
Pollution degree	3

### Electrical properties

Maximum power dissipation for nominal condition	0.43 W
Test voltage (Winding/contact)	4 kV AC (50 Hz, 1 min., winding/contact)
Rated surge voltage	6 kV

### Input data

#### Coil side

Nominal input voltage $U_N$	24 V DC
Input voltage range	20.2 V DC ... 33.6 V DC (20 °C)
Typical input current at $U_N$	18 mA
Typical response time	8 ms
Typical release time	10 ms
Protective circuit	Reverse polarity protection; Polarity protection diode Freewheeling diode; Freewheeling diode
Operating voltage display	Yellow LED

### Output data

#### Switching

Contact type	1 changeover contact
Type of switch contact	Single contact
Drive and function	monostable
Drive (polarity)	polarized
Contact material	AgNi
Maximum switching voltage	250 V AC/DC (The separating plate PLC-ATP should be installed for voltages larger than 250 V (L1, L2, L3) between identical terminal blocks in adjacent modules. Potential bridging is then carried out with FBST 8-PLC... or ...FBST 500...)

# PLC-RSC- 24DC/21HC - Relay Module



2967620

<https://www.phoenixcontact.com/in/products/2967620>

Minimum switching voltage	12 V (10 mA)
Limiting continuous current	10 A
	6 A (value applies to connections 12. If connections 12 are bridged, the normal value applies.)
Maximum inrush current	30 A (300 ms)
Min. switching current	10 mA (12 V)
Interrupting rating (ohmic load) max.	240 W (at 24 V DC)
	58 W (at 48 V DC)
	48 W (at 60 V DC)
	50 W (at 110 V DC)
	80 W (at 220 V DC)
	2500 VA (for 250 V AC)
Interrupting rating (ohmic load) max. bridged	144 W (for 24 V DC. Value applies to connections 12. If connections 12 are bridged, the normal value applies.)
	1500 VA (for 250 V AC. Value applies to connections 12. If connections 12 are bridged, the normal value applies.)
Switching capacity	2 A (at 24 V, DC13)
	0.2 A (at 110 V, DC13)
	0.2 A (at 250 V, DC13)
	6 A (at 24 V, AC15)
	6 A (at 120 V, AC15)
	6 A (at 250 V, AC15)

## Connection data

Connection method	Screw connection
Stripping length	8 mm
Screw thread	M3
Conductor cross section rigid	0.14 mm <sup>2</sup> ... 2.5 mm <sup>2</sup>
Conductor cross section flexible	0.14 mm <sup>2</sup> ... 2.5 mm <sup>2</sup>
	0.2 mm <sup>2</sup> ... 2.5 mm <sup>2</sup> (Single ferrule)
	2x 0.5 mm <sup>2</sup> ... 1.5 mm <sup>2</sup> (TWIN ferrule)
Conductor cross section AWG	26 ... 14
Tightening torque	0.6 Nm ... 0.8 Nm

## Dimensions

Width	14 mm
Height	80 mm
Depth	94 mm

## Material specifications

Flammability rating according to UL 94	V0 (Housing)
--	--------------

## Environmental and real-life conditions

### Ambient conditions

Degree of protection (Relay)	RT II (Relay)
------------------------------	---------------

# PLC-RSC- 24DC/21HC - Relay Module



2967620

<https://www.phoenixcontact.com/in/products/2967620>

Degree of protection (Relay base)	IP20 (Relay base)
Ambient temperature (operation)	-40 °C ... 60 °C
Ambient temperature (storage/transport)	-40 °C ... 85 °C

## Approvals

### Corrosive gas test

Identification	ISA-S71.04. G3 Harsh Group
	EN 60068-2-60

## Standards and regulations

Standards/regulations	IEC 60947-5-1
-----------------------	---------------

## Mounting

Mounting type	DIN rail mounting
Assembly instructions	in rows with zero spacing
Mounting position	any

## Drawings

Diagram

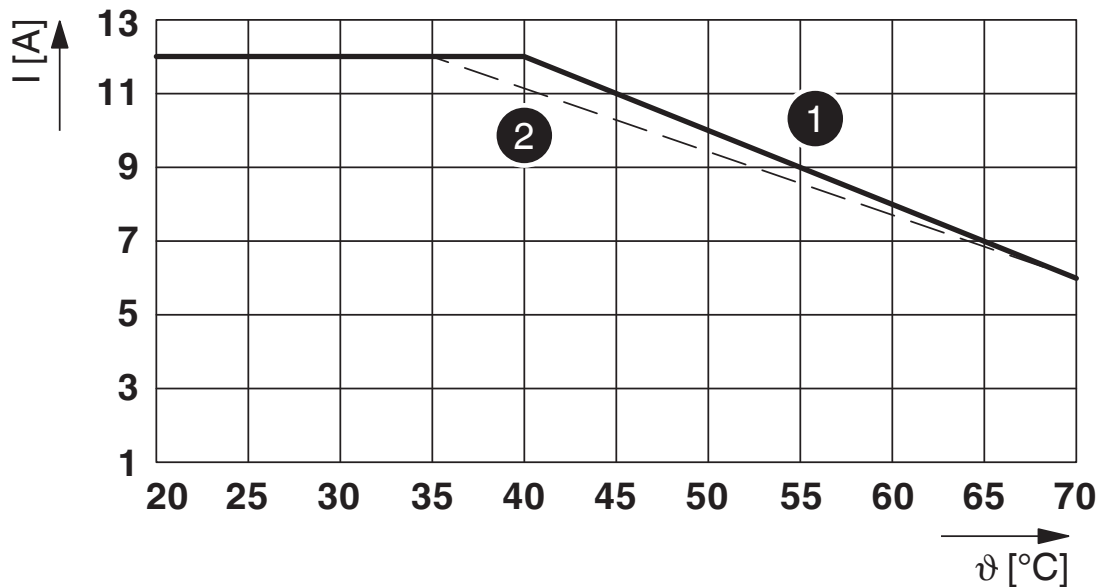

Limiting continuous current per contact for 0.85 ... 1.1  $U_N$  (contact-side)

- (1) Limiting continuous current for horizontal installation position without clearance
- (2) Limiting continuous current for vertical installation position without clearance

Circuit diagram

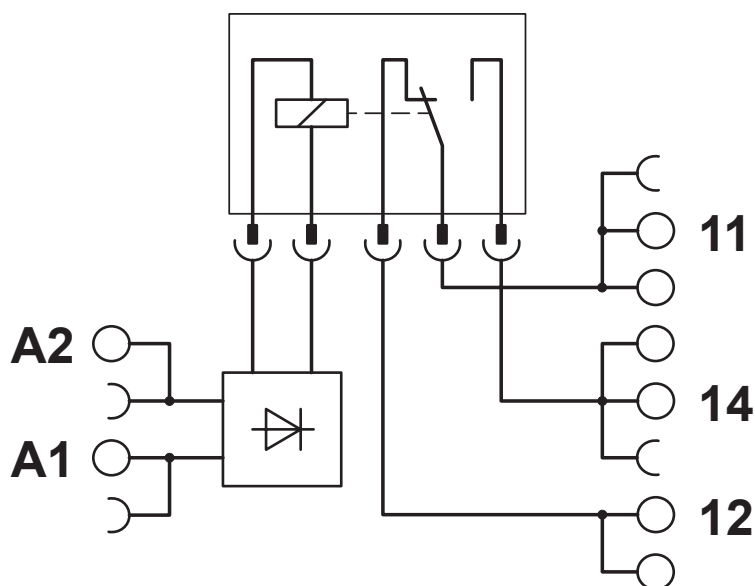

Diagram

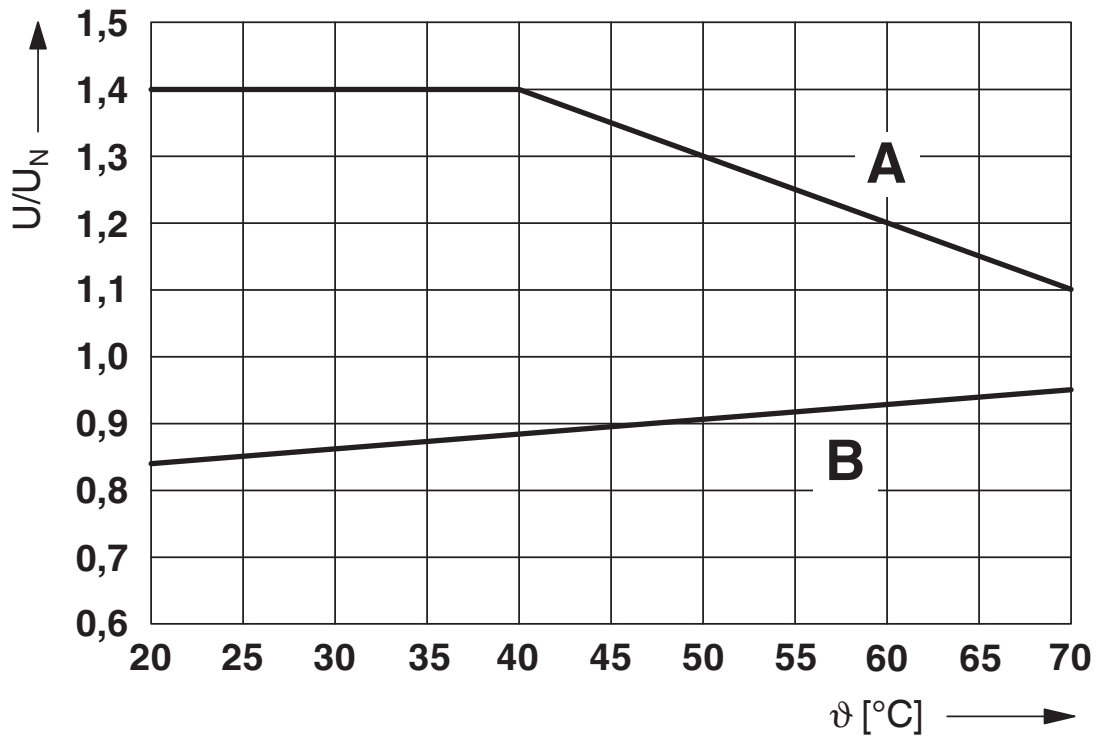

### Curve A

Maximum permissible continuous voltage  $U_{\max}$  with limiting continuous current on the contact side (see relevant technical data)

### Curve B

Minimum permissible operate voltage  $U_{\text{op}}$  after pre-excitation (see relevant technical data)

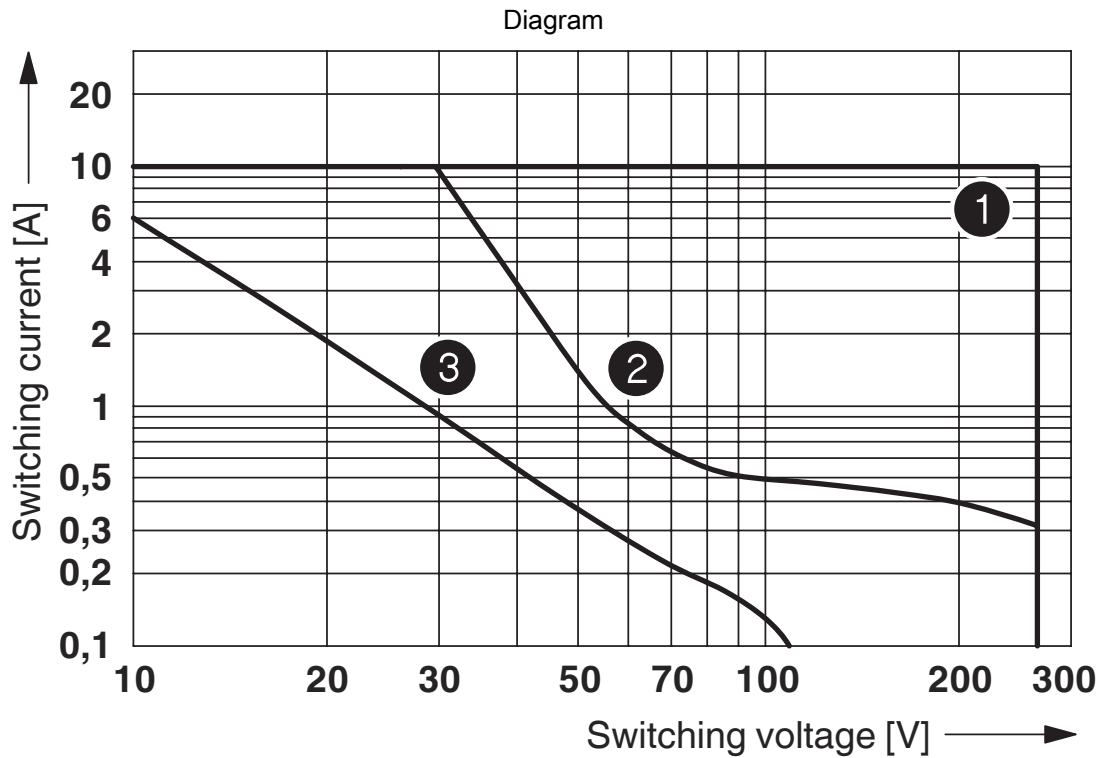

- ① AC, ohmic load
- ② DC, ohmic load
- ③ DC, L/R = 40 ms

Interrupting rating



# PLC-RSC- 24DC/21HC - Relay Module



2967620

<https://www.phoenixcontact.com/in/products/2967620>

## Approvals



**cUL Recognized**  
Approval ID: FILE E 238705



**UL Recognized**  
Approval ID: FILE E 238705



**EAC**  
Approval ID: TR\_TS\_D\_00573\_c



**DNV GL**  
Approval ID: TAE0000196



**EAC**  
Approval ID: RU\*C-DE.\*08.B.00010



**PRS**  
Approval ID: TE/2109/880590/16



**UL Listed**  
Approval ID: FILE E 172140



**cUL Listed**  
Approval ID: FILE E 172140



**RC FRT**  
Approval ID: B.00094

# PLC-RSC- 24DC/21HC - Relay Module



2967620

<https://www.phoenixcontact.com/in/products/2967620>

## Classifications

### ECLASS

ECLASS-11.0	27371601
ECLASS-12.0	27371601
ECLASS-13.0	27371601

### ETIM

ETIM 8.0	EC001437
----------	----------

### UNSPSC

UNSPSC 21.0	39122300
-------------	----------

# PLC-RSC- 24DC/21HC - Relay Module



2967620

<https://www.phoenixcontact.com/in/products/2967620>

## Environmental Product Compliance

REACH SVHC	Lead 7439-92-1
	Hexahydromethylphthalic anhydride
China RoHS	Environmentally Friendly Use Period = 50 years
	For information on hazardous substances, refer to the manufacturer's declaration available under "Downloads"

# PLC-RSC- 24DC/21HC - Relay Module

2967620

<https://www.phoenixcontact.com/in/products/2967620>

## Accessories

 Note: Applying some accessories below might limit this product.

### FBST 500-PLC RD - Continuous plug-in bridge

2966786

<https://www.phoenixcontact.com/in/products/2966786>



Continuous plug-in bridge, length: 500 mm, color: red

 Max. current carrying capacity: 32 A

---

### FBST 500-PLC BU - Continuous plug-in bridge

2966692

<https://www.phoenixcontact.com/in/products/2966692>

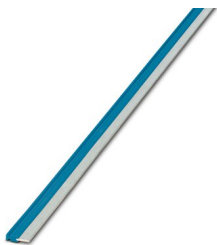

Continuous plug-in bridge, length: 500 mm, color: blue

 Max. current carrying capacity: 32 A

# PLC-RSC- 24DC/21HC - Relay Module

2967620

<https://www.phoenixcontact.com/in/products/2967620>

## FBST 500-PLC GY - Continuous plug-in bridge

2966838

<https://www.phoenixcontact.com/in/products/2966838>



Continuous plug-in bridge, length: 500 mm, color: gray

 Max. current carrying capacity: 32 A

---

## FBST 6-PLC RD - Single plug-in bridge

2966236

<https://www.phoenixcontact.com/in/products/2966236>

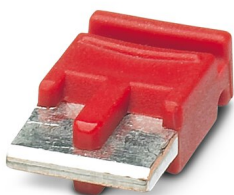

Single plug-in bridge, number of positions: 2, length: 6 mm, color: red

 Max. current carrying capacity: 6 A

# PLC-RSC- 24DC/21HC - Relay Module

2967620

<https://www.phoenixcontact.com/in/products/2967620>

## FBST 6-PLC BU - Single plug-in bridge

2966812

<https://www.phoenixcontact.com/in/products/2966812>

Single plug-in bridge, number of positions: 2, length: 6 mm, color: blue

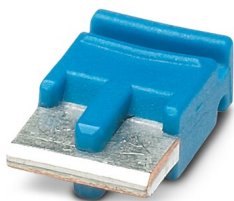

 Max. current carrying capacity: 6 A

---

## FBST 6-PLC GY - Single plug-in bridge

2966825

<https://www.phoenixcontact.com/in/products/2966825>

Single plug-in bridge, number of positions: 2, length: 6 mm, color: gray

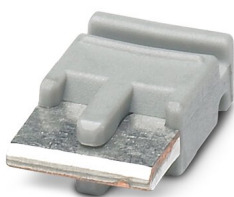

 Max. current carrying capacity: 6 A

# PLC-RSC- 24DC/21HC - Relay Module

2967620

<https://www.phoenixcontact.com/in/products/2967620>

## FBST 8-PLC GY - Single plug-in bridge

2967688

<https://www.phoenixcontact.com/in/products/2967688>

Single plug-in bridge, number of positions: 2, length: 8 mm, color: gray



 Max. current carrying capacity: 6 A

---

## FBST 14-PLC BK - Single plug-in bridge

2967691

<https://www.phoenixcontact.com/in/products/2967691>

Single plug-in bridge, number of positions: 2, length: 14 mm, color: black



 Max. current carrying capacity: 10 A

# PLC-RSC- 24DC/21HC - Relay Module



2967620

<https://www.phoenixcontact.com/in/products/2967620>

## PLC-ATP BK - Separating plate

2966841

<https://www.phoenixcontact.com/in/products/2966841>



Separating plate, 2 mm thick, required at the start and end of a PLC terminal strip. Furthermore, it is used for: visual separation of groups, safe isolation of different voltages of neighboring PLC relays in acc. with DIN VDE 0106-101, isolation

---

## PLC-ESK GY - Power terminal block

2966508

<https://www.phoenixcontact.com/in/products/2966508>



Power terminal block, for the input of up to four potentials, for mounting on NS 35/7.5



# PLC-RSC- 24DC/21HC - Relay Module

2967620

<https://www.phoenixcontact.com/in/products/2967620>



## SZF 1-0,6X3,5 - Screwdriver

1204517

<https://www.phoenixcontact.com/in/products/1204517>



Actuation tool, for ST terminal blocks, also suitable for use as a bladed screwdriver, size: 0.6 x 3.5 x 100 mm, 2-component grip, with non-slip grip

---

## PLC-V8L/FLK14/OUT - System connection

2299660

<https://www.phoenixcontact.com/in/products/2299660>



V8 adapter for 8 x PLC-INTERFACE (14 mm), controller: PLC system cabling of output cards, connection 1: Screw connection 1x, connection 2: IDC/FLK pin strip 1x 14-position, connection 3: Plug-in connection (Can be snapped onto 8x PLC-INTERFACE terminals), number of channels: 8, control logic: plusschaltend

# PLC-RSC- 24DC/21HC - Relay Module

2967620

<https://www.phoenixcontact.com/in/products/2967620>



## PLC-V8L/FLK14/OUT/M - System connection

2304306

<https://www.phoenixcontact.com/in/products/2304306>



V8 adapter for 8 x PLC-INTERFACE (14 mm), controller: PLC system cabling of output cards, connection 1: Screw connection 1x, connection 2: IDC/FLK pin strip 1x 14-position, connection 3: Plug-in connection (Can be snapped onto 8x PLC-INTERFACE terminals), number of channels: 8, control logic: minusschaltend

---

## ZB 10:UNBEDRUCKT - Zack marker strip

1053001

<https://www.phoenixcontact.com/in/products/1053001>



Zack marker strip, Strip, white, unlabeled, can be labeled with: PLOTMARK, CMS-P1-PLOTTER, mounting type: snapped, for terminal block width: 10.2 mm, lettering field size: 10.5 x 10.15 mm, Number of individual labels: 10

# PLC-RSC- 24DC/21HC - Relay Module



2967620

<https://www.phoenixcontact.com/in/products/2967620>

## ZB 10 CUS - Zack marker strip

0824941

<https://www.phoenixcontact.com/in/products/0824941>



Zack marker strip, can be ordered: Strip, white, labeled according to customer specifications, mounting type: snap into tall marker groove, for terminal block width: 10.2 mm, lettering field size: 10,15 x 10,5 mm, Number of individual labels: 10

---

## ZB10,LGS:FORTL.ZAHLEN - Zack marker strip

1053014

<https://www.phoenixcontact.com/in/products/1053014>



Zack marker strip, Strip, white, labeled, can be labeled with: CMS-P1-PLOTTER, printed horizontally: consecutive numbers 1 ... 10, 11 ... 20, etc. up to 91 ... 100, mounting type: snapped, for terminal block width: 10.2 mm, lettering field size: 10,15 x 10,5 mm, Number of individual labels: 10

# PLC-RSC- 24DC/21HC - Relay Module



2967620

<https://www.phoenixcontact.com/in/products/2967620>

## ZB10,QR:FORTL.ZAHLEN - Zack marker strip

1053027

<https://www.phoenixcontact.com/in/products/1053027>

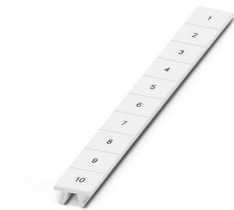

Zack marker strip, Strip, white, labeled, can be labeled with: CMS-P1-PLOTTER, Printed vertically: consecutive numbers 1 ... 10, 11 ... 20, etc. up to 91 ... 100, mounting type: snapped, for terminal block width: 10.2 mm, lettering field size: 10,15 x 10,5 mm, Number of individual labels: 10

---

## ZB10,LGS:L1-N,PE - Marker for terminal blocks

1053412

<https://www.phoenixcontact.com/in/products/1053412>



Marker for terminal blocks, Strip, white, labeled, can be labeled with: CMS-P1-PLOTTER, horizontal: L1, L2, L3, N, PE, L1, L2, L3, N, PE, mounting type: snapped, for terminal block width: 10.2 mm, lettering field size: 10,15 x 10,5 mm, Number of individual labels: 10

# PLC-RSC- 24DC/21HC - Relay Module



2967620

<https://www.phoenixcontact.com/in/products/2967620>

## ZB10,LGS:U-N - Marker for terminal blocks

1053438

<https://www.phoenixcontact.com/in/products/1053438>



Marker for terminal blocks, Strip, white, labeled, can be labeled with: CMS-P1-PLOTTER, horizontal: U, V, W, N, GND, U, V, W, N, GND, mounting type: snapped, for terminal block width: 10.2 mm, lettering field size: 10,15 x 10,5 mm, Number of individual labels: 10

---

## UC-TM 10 - Marker for terminal blocks

0818069

<https://www.phoenixcontact.com/in/products/0818069>



Marker for terminal blocks, Sheet, white, unlabeled, can be labeled with: BLUEMARK ID COLOR, BLUEMARK ID, BLUEMARK CLED, PLOTMARK, CMS-P1-PLOTTER, mounting type: snapped, for terminal block width: 10.2 mm, lettering field size: 9.6 x 10.5 mm, Number of individual labels: 48

# PLC-RSC- 24DC/21HC - Relay Module



2967620

<https://www.phoenixcontact.com/in/products/2967620>

## UC-TM 10 CUS - Marker for terminal blocks

0824605

<https://www.phoenixcontact.com/in/products/0824605>



Marker for terminal blocks, can be ordered: by sheet, white, labeled according to customer specifications, mounting type: snap into tall marker groove, for terminal block width: 10.2 mm, lettering field size: 9.6 x 10.5 mm, Number of individual labels: 48

---

## UCT-TM 10 - Marker for terminal blocks

0829142

<https://www.phoenixcontact.com/in/products/0829142>



Marker for terminal blocks, Sheet, white, unlabeled, can be labeled with: TOPMARK NEO, TOPMARK LASER, BLUEMARK ID COLOR, BLUEMARK ID, BLUEMARK CLED, THERMOMARK PRIME, THERMOMARK CARD 2.0, THERMOMARK CARD, mounting type: snapped, for terminal block width: 10.2 mm, lettering field size: 8.9 x 9.6 mm, Number of individual labels: 36

# PLC-RSC- 24DC/21HC - Relay Module



2967620

<https://www.phoenixcontact.com/in/products/2967620>

## UCT-TM 10 CUS - Marker for terminal blocks

0829623

<https://www.phoenixcontact.com/in/products/0829623>



Marker for terminal blocks, can be ordered: by sheet, white, labeled according to customer specifications, mounting type: snap into tall marker groove, for terminal block width: 10.2 mm, lettering field size: 8.9 x 9.6 mm, Number of individual labels: 36

---

## ZB 12:UNPRINTED - Zack marker strip

0812120

<https://www.phoenixcontact.com/in/products/0812120>

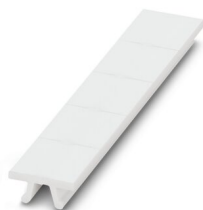

Zack marker strip, Strip, white, unlabeled, can be labeled with: PLOTMARK, CMS-P1-PLOTTER, mounting type: snapped, for terminal block width: 12.2 mm, lettering field size: 12 x 10.5 mm, Number of individual labels: 5

# PLC-RSC- 24DC/21HC - Relay Module



2967620

<https://www.phoenixcontact.com/in/products/2967620>

## ZB 12 CUS - Zack marker strip

0824942

<https://www.phoenixcontact.com/in/products/0824942>

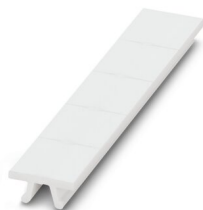

Zack marker strip, can be ordered: Strip, white, labeled according to customer specifications, mounting type: snap into tall marker groove, for terminal block width: 12.2 mm, lettering field size: 10.5 x 12.15 mm, Number of individual labels: 5

---

## ZB 12,LGS:L1-N,PE - Zack marker strip

0812146

<https://www.phoenixcontact.com/in/products/0812146>

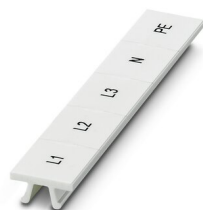

Zack marker strip, Strip, white, labeled, printed horizontally: L1, L2, L3, N, PE, mounting type: snapped, for terminal block width: 12.2 mm, lettering field size: 10.5 x 12.15 mm, Number of individual labels: 5



# PLC-RSC- 24DC/21HC - Relay Module



2967620

<https://www.phoenixcontact.com/in/products/2967620>

## UC-TM 12 - Marker for terminal blocks

0819194

<https://www.phoenixcontact.com/in/products/0819194>



Marker for terminal blocks, Sheet, white, unlabeled, can be labeled with: BLUEMARK ID COLOR, BLUEMARK ID, BLUEMARK CLED, PLOTMARK, CMS-P1-PLOTTER, mounting type: snapped, for terminal block width: 12 mm, lettering field size: 11.45 x 10.5 mm, Number of individual labels: 40

---

## UC-TM 12 CUS - Marker for terminal blocks

0824613

<https://www.phoenixcontact.com/in/products/0824613>



Marker for terminal blocks, can be ordered: by sheet, white, labeled according to customer specifications, mounting type: snap into tall marker groove, for terminal block width: 12 mm, lettering field size: 11.45 x 10.5 mm, Number of individual labels: 40

# PLC-RSC- 24DC/21HC - Relay Module



2967620

<https://www.phoenixcontact.com/in/products/2967620>

## UCT-TM 12 - Marker for terminal blocks

0829144

<https://www.phoenixcontact.com/in/products/0829144>



Marker for terminal blocks, Sheet, white, unlabeled, can be labeled with: TOPMARK NEO, TOPMARK LASER, BLUEMARK ID COLOR, BLUEMARK ID, BLUEMARK CLED, THERMOMARK PRIME, THERMOMARK CARD 2.0, THERMOMARK CARD, mounting type: snapped, for terminal block width: 12 mm, lettering field size: 10.8 x 9.6 mm, Number of individual labels: 30

---

## UCT-TM 12 CUS - Marker for terminal blocks

0829630

<https://www.phoenixcontact.com/in/products/0829630>



Marker for terminal blocks, can be ordered: by sheet, white, labeled according to customer specifications, mounting type: snap into tall marker groove, for terminal block width: 12 mm, lettering field size: 10.8 x 9.6 mm, Number of individual labels: 30

# PLC-RSC- 24DC/21HC - Relay Module



2967620

<https://www.phoenixcontact.com/in/products/2967620>

## NS 35/ 7,5 PERF 2000MM - DIN rail perforated

0801733

<https://www.phoenixcontact.com/in/products/0801733>



DIN rail perforated, acc. to EN 60715, material: Steel, galvanized, passivated with a thick layer, Standard profile, color: silver, Pack of 25 (50 m)

---

## NS 35/ 7,5 UNPERF 2000MM - DIN rail, unperforated

0801681

<https://www.phoenixcontact.com/in/products/0801681>



DIN rail, unperforated, acc. to EN 60715, material: Steel, galvanized, passivated with a thick layer, Standard profile, color: silver, Pack of 25 (50 m)

# PLC-RSC- 24DC/21HC - Relay Module



2967620

<https://www.phoenixcontact.com/in/products/2967620>

## NS 35/ 7,5 WH PERF 2000MM - DIN rail perforated

1204119

<https://www.phoenixcontact.com/in/products/1204119>



DIN rail perforated, acc. to EN 60715, material: Steel, Galvanized, white passivated, Standard profile, color: silver, Pack of 25 (50 m)

---

## NS 35/ 7,5 WH UNPERF 2000MM-VPE 10 - DIN rail, unperforated

1204122

<https://www.phoenixcontact.com/in/products/1204122>



DIN rail, unperforated, acc. to EN 60715, material: Steel, Galvanized, white passivated, Standard profile, color: silver, Pack of 10 (20 m)

# PLC-RSC- 24DC/21HC - Relay Module

2967620

<https://www.phoenixcontact.com/in/products/2967620>



## NS 35/ 7,5 AL UNPERF 2000MM - DIN rail, unperforated

0801704

<https://www.phoenixcontact.com/in/products/0801704>



DIN rail, unperforated, acc. to EN 60715, material: Aluminum, uncoated, Standard profile, color: silver, Pack of 25 (50 m)

---

## NS 35/ 7,5 ZN PERF 2000MM - DIN rail perforated

1206421

<https://www.phoenixcontact.com/in/products/1206421>



DIN rail perforated, acc. to EN 60715, material: Steel, galvanized, Standard profile, color: silver, Pack of 25 (50 m)

# PLC-RSC- 24DC/21HC - Relay Module

2967620

<https://www.phoenixcontact.com/in/products/2967620>



## NS 35/ 7,5 ZN UNPERF 2000MM - DIN rail, unperforated

1206434

<https://www.phoenixcontact.com/in/products/1206434>



DIN rail, unperforated, acc. to EN 60715, material: Steel, galvanized, Standard profile, color: silver, Pack of 25 (50 m)

---

## NS 35/ 7,5 CU UNPERF 2000MM-VPE 10 - DIN rail, unperforated

0801762

<https://www.phoenixcontact.com/in/products/0801762>



DIN rail, unperforated, acc. to EN 60715, material: Copper, uncoated, Standard profile, color: copper-colored, Pack of 10 (20 m)

# PLC-RSC- 24DC/21HC - Relay Module

2967620

<https://www.phoenixcontact.com/in/products/2967620>

## NS 35/ 7,5 CAP - End cap

1206560

<https://www.phoenixcontact.com/in/products/1206560>

DIN rail end piece, for DIN rail NS 35/7.5



---

## NS 35/15 PERF 2000MM - DIN rail perforated

1201730

<https://www.phoenixcontact.com/in/products/1201730>

DIN rail perforated, similar to EN 60715, material: Steel, galvanized, passivated with a thick layer, Standard profile, color: silver, Pack of 25 (50 m)



# PLC-RSC- 24DC/21HC - Relay Module



2967620

<https://www.phoenixcontact.com/in/products/2967620>

## NS 35/15 UNPERF 2000MM - DIN rail, unperforated

1201714

<https://www.phoenixcontact.com/in/products/1201714>



DIN rail, unperforated, similar to EN 60715, material: Steel, galvanized, passivated with a thick layer, Standard profile, color: silver, Pack of 25 (50 m)

---

## NS 35/15 WH PERF 2000MM - DIN rail perforated

0806602

<https://www.phoenixcontact.com/in/products/0806602>



DIN rail perforated, similar to EN 60715, material: Steel, Galvanized, white passivated, Standard profile, color: white, Pack of 25 (50 m)



# PLC-RSC- 24DC/21HC - Relay Module

2967620

<https://www.phoenixcontact.com/in/products/2967620>



## NS 35/15 WH UNPERF 2000MM-VPE 10 - DIN rail, unperforated

1204135

<https://www.phoenixcontact.com/in/products/1204135>



DIN rail, unperforated, similar to EN 60715, material: Steel, Galvanized, white passivated, Standard profile, color: silver, Pack of 10 (20 m)

---

## NS 35/15 AL UNPERF 2000MM - DIN rail, unperforated

1201756

<https://www.phoenixcontact.com/in/products/1201756>



DIN rail, unperforated, similar to EN 60715, material: Aluminum, uncoated, Standard profile, color: silver

# PLC-RSC- 24DC/21HC - Relay Module

2967620

<https://www.phoenixcontact.com/in/products/2967620>

## NS 35/15 ZN PERF 2000MM - DIN rail perforated

1206599

<https://www.phoenixcontact.com/in/products/1206599>



DIN rail perforated, similar to EN 60715, material: Steel, galvanized, Standard profile, color: silver, Pack of 25 (50 m)

---

## NS 35/15 ZN UNPERF 2000MM - DIN rail, unperforated

1206586

<https://www.phoenixcontact.com/in/products/1206586>



DIN rail, unperforated, similar to EN 60715, material: Steel, galvanized, Standard profile, color: silver, Pack of 25 (50 m)

# PLC-RSC- 24DC/21HC - Relay Module



2967620

<https://www.phoenixcontact.com/in/products/2967620>

## NS 35/15 CU UNPERF 2000MM-VPE 10 - DIN rail, unperforated

1201895

<https://www.phoenixcontact.com/in/products/1201895>



DIN rail, unperforated, similar to EN 60715, material: Copper, uncoated, Standard profile, color: copper-colored, Pack of 10 (20 m)

---

## NS 35/15 CAP - End cap

1206573

<https://www.phoenixcontact.com/in/products/1206573>

DIN rail end piece, for DIN rail NS 35/15



# PLC-RSC- 24DC/21HC - Relay Module

2967620

<https://www.phoenixcontact.com/in/products/2967620>



## NS 35/15-2,3 UNPERF 2000MM-VPE 10 - DIN rail, unperforated

1201798

<https://www.phoenixcontact.com/in/products/1201798>



DIN rail, unperforated, acc. to EN 60715, material: Steel, galvanized, passivated with a thick layer, Standard profile 2.3 mm, color: silver, Pack of 10 (20 m)

---

## PLC-BSC- 24DC/21HC - Relay base

2967772

<https://www.phoenixcontact.com/in/products/2967772>



14 mm PLC basic terminal block for high continuous currents with screw connection, without relay or solid-state relay, for mounting on DIN rail NS 35/7,5, 1 changeover contact, input voltage 24 V DC

# PLC-RSC- 24DC/21HC - Relay Module

2967620

<https://www.phoenixcontact.com/in/products/2967620>



## REL-MR- 24DC/21HC - Single relay

2961312

<https://www.phoenixcontact.com/in/products/2961312>

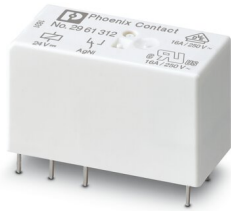

Plug-in miniature power relay, with power contact for high continuous currents, 1 changeover contact, input voltage 24 V DC

---

Phoenix Contact 2023 © - all rights reserved

<https://www.phoenixcontact.com>

PHOENIX CONTACT (I) Pvt. Ltd.

A-58/2, Okhla Industrial Area, Phase - II, New Delhi-110 020

+91.1275.71420

[info@phoenixcontact.co.in](mailto:info@phoenixcontact.co.in)