

ICV 2,5/13-G-5,08 - PCB header



1786051

<https://www.phoenixcontact.com/in/products/1786051>

Please be informed that the data shown in this PDF document is generated from our Online Catalog. Please find the complete data in the user documentation. Our General Terms of Use for Downloads are valid.

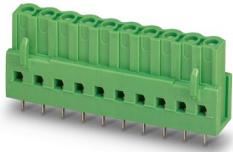

PCB headers, nominal cross section: 2.5 mm², color: green, nominal current: 12 A, rated voltage (III/2): 320 V, contact surface: Tin, type of contact: Socket, number of potentials: 13, number of rows: 1, number of positions: 13, number of connections: 13, product range: ICV 2,5/..-G, pitch: 5.08 mm, mounting: Wave soldering, pin layout: Linear pinning, solder pin [P]: 3.6 mm, number of solder pins per potential: 2, plug-in system: COMBICON MSTB 2,5, Pin connector pattern alignment: Standard, locking: without, mounting: without, type of packaging: packed in cardboard

Your advantages

- Maximum flexibility when it comes to device design – one header for connectors with different connection technologies
- Easy PCB replacement thanks to plug-in modules
- Well-known mounting principle allows worldwide use
- Inverted header with socket contacts for touch-proof device outputs or PCB/PCB connections

Commercial Data

Item number	1786051
Packing unit	50 pc
Minimum order quantity	50 pc
Sales Key	AAC
Product Key	AACSAG
Catalog Page	Page 333 (C-1-2013)
GTIN	4017918042202
Weight per Piece (including packing)	12.15 g
Weight per Piece (excluding packing)	8.992 g
Customs tariff number	85366930
Country of origin	DE

ICV 2,5/13-G-5,08 - PCB header



1786051

<https://www.phoenixcontact.com/in/products/1786051>

Technical Data

Product properties

Type	Inverted
Product line	COMBICON Connectors M
Product type	PCB headers
Product family	ICV 2,5/...G
Number of positions	13
Pitch	5.08 mm
Number of connections	13
Number of rows	1
Mounting flange	without
Number of potentials	13
Pin layout	Linear pinning
Solder pins per potential	2

Electrical properties

Nominal current I_N	12 A
Nominal voltage U_N	320 V
Degree of pollution	3
Contact resistance	1.5 m Ω
Rated voltage (III/3)	320 V
Rated surge voltage (III/3)	4 kV
Rated voltage (III/2)	320 V
Rated surge voltage (III/2)	4 kV
Rated voltage (II/2)	630 V
Rated surge voltage (II/2)	4 kV

Mounting

Mounting type	Wave soldering
Pin layout	Linear pinning

Material specifications

Material data - contact

Note	WEEE/RoHS-compliant, free of whiskers according to IEC 60068-2-82/JEDEC JESD 201
Contact material	Cu alloy
Surface characteristics	hot-dip tin-plated
Metal surface contact area (top layer)	Tin (4 - 8 μm Sn)
Metal surface soldering area (top layer)	Tin (4 - 8 μm Sn)

Material data - housing

Color (Housing)	green (6021)
Insulating material	PA

ICV 2,5/13-G-5,08 - PCB header

1786051

<https://www.phoenixcontact.com/in/products/1786051>

Insulating material group	I
CTI according to IEC 60112	600
Flammability rating according to UL 94	V0
Glow wire flammability index GWFI according to EN 60695-2-12	850
Glow wire ignition temperature GWIT according to EN 60695-2-13	775
Temperature for the ball pressure test according to EN 60695-10-2	125 °C

Material data – actuating element

Color ()	()
-----------	-----

Notes

Notes on operation	In accordance with IEC 61984, COMBICON connectors have no switching power (COC). During designated use, they must not be plugged in or disconnected when carrying voltage or under load.
--------------------	--

Dimensions

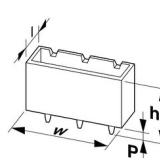
Dimensional drawing	
Pitch	5.08 mm
Width [w]	68.04 mm
Height [h]	22.4 mm
Length [l]	10.2 mm
Installed height	18.9 mm
Solder pin length [P]	3.6 mm

PCB design

Pin spacing	5.08 mm
-------------	---------

Mechanical tests

Test for conductor damage and slackening

Specification	IEC 60999-1:1999-11
Result	Test passed

Repeated connection and disconnection

Specification	IEC 60999-1:1999-11
Result	Test passed

Pull-out test

Specification	IEC 60999-1:1999-11
Conductor cross section/conductor type/tractive force setpoint/actual value	0.2 mm ² / solid / > 10 N
	0.2 mm ² / flexible / > 10 N

1786051

<https://www.phoenixcontact.com/in/products/1786051>

	2.5 mm ² / solid / > 50 N
	2.5 mm ² / flexible / > 50 N

Insertion and withdrawal forces

Result	Test passed
No. of cycles	25
Insertion strength per pos. approx.	8 N
Withdraw strength per pos. approx.	6 N

Contact holder in insert

Specification	IEC 60512-15-1:2008-05
Contact holder in insert Requirements >20 N	Test passed

Resistance of inscriptions

Specification	IEC 60068-2-70:1995-12
Result	Test passed

Polarization and coding

Specification	IEC 60512-13-5:2006-02
Result	Test passed

Visual inspection

Specification	IEC 60512-1-1:2002-02
Result	Test passed

Dimension check

Specification	IEC 60512-1-2:2002-02
Result	Test passed

Electrical tests

Thermal test | Test group C

Specification	IEC 60512-5-1:2002-02
Tested number of positions	16

Insulation resistance

Specification	IEC 60512-3-1:2002-02
Insulation resistance, neighboring positions	> 5 MΩ

Air clearances and creepage distances |

Specification	IEC 60664-1:2007-04
Insulating material group	I
Comparative tracking index (IEC 60112)	CTI 600
Rated insulation voltage (III/3)	320 V
Rated surge voltage (III/3)	4 kV
minimum clearance value - non-homogenous field (III/3)	3 mm
minimum creepage distance (III/3)	4 mm

ICV 2,5/13-G-5,08 - PCB header



1786051

<https://www.phoenixcontact.com/in/products/1786051>

Rated insulation voltage (III/2)	320 V
Rated surge voltage (III/2)	4 kV
minimum clearance value - non-homogenous field (III/2)	3 mm
minimum creepage distance (III/2)	3 mm
Rated insulation voltage (II/2)	630 V
Rated surge voltage (II/2)	4 kV
minimum clearance value - non-homogenous field (II/2)	3 mm
minimum creepage distance (II/2)	3.2 mm

Environmental and real-life conditions

Vibration test

Specification	IEC 60068-2-6:2007-12
Frequency	10 - 150 - 10 Hz
Sweep speed	1 octave/min
Amplitude	0.35 mm (10 Hz ... 60.1 Hz)
Sweep speed	5g (60.1 Hz ... 150 Hz)
Test duration per axis	2.5 h

Durability test

Specification	IEC 60512-9-1:2010-03
Impulse withstand voltage at sea level	4.8 kV
Contact resistance R_1	1.5 m Ω
Contact resistance R_2	1.5 m Ω
Insertion/withdrawal cycles	25
Insulation resistance, neighboring positions	> 5 M Ω

Climatic test

Specification	ISO 6988:1985-02
Corrosive stress	0.2 dm ³ SO ₂ on 300 dm ³ /40 °C/1 cycle
Thermal stress	100 °C/168 h
Power-frequency withstand voltage	2.21 kV

Ambient conditions

Ambient temperature (operation)	-40 °C ... 100 °C (dependent on the derating curve)
Ambient temperature (storage/transport)	-40 °C ... 70 °C
Relative humidity (storage/transport)	30 % ... 70 %
Ambient temperature (assembly)	-5 °C ... 100 °C

Packaging specifications

Type of packaging	packed in cardboard
-------------------	---------------------

Drawings

Diagram

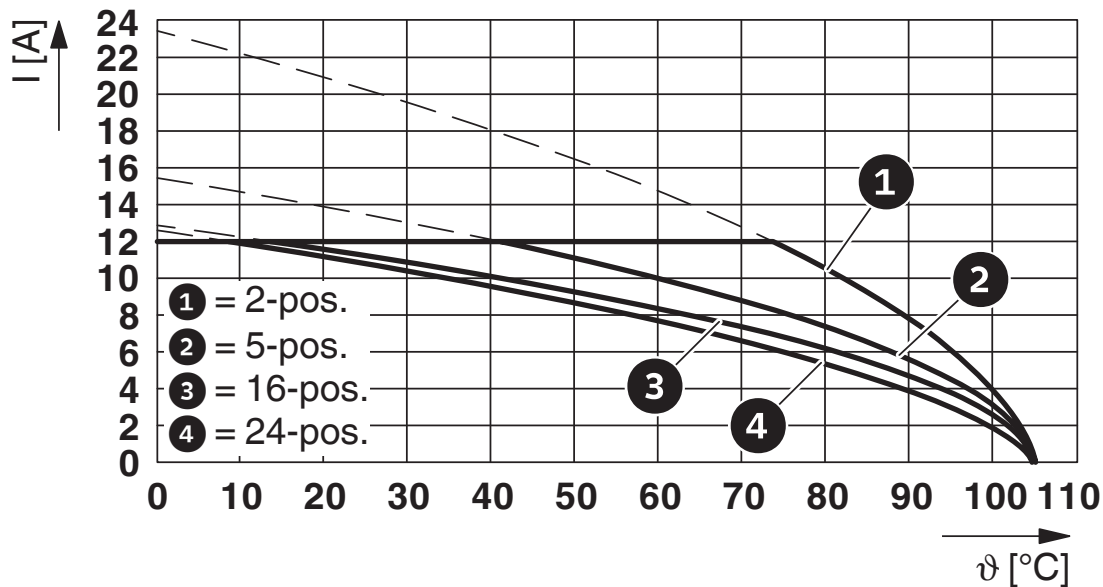

Type: ICV 2,5/...-G-5,08 with MSTBV 2,5/...-G-5,08

Diagram

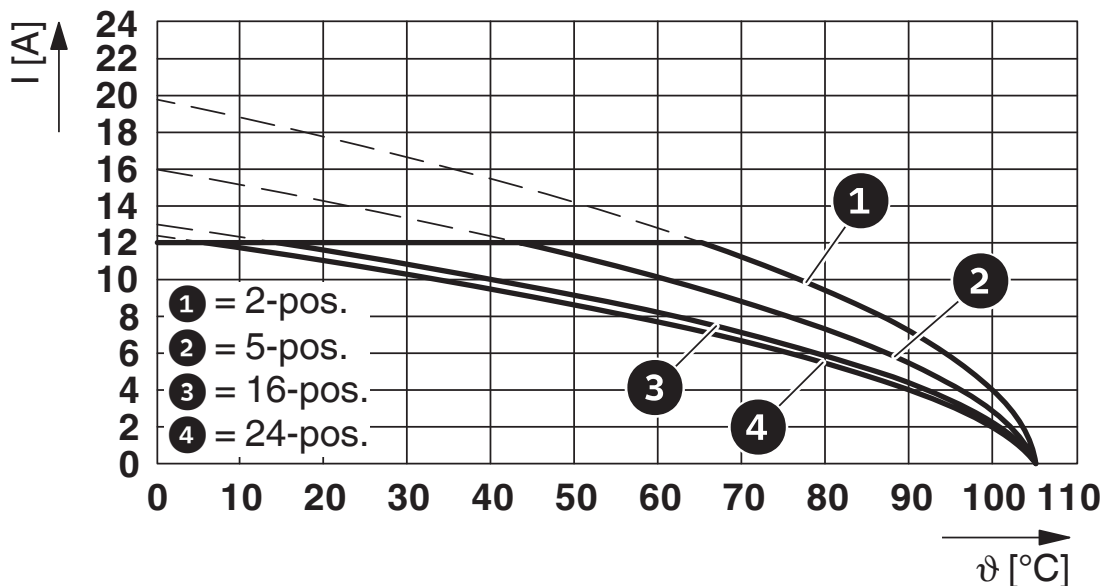

Type: ICV 2,5/...-G-5,08 with MSTBVA 2,5/...-G-5,08

ICV 2,5/13-G-5,08 - PCB header

1786051

<https://www.phoenixcontact.com/in/products/1786051>

Dimensional drawing

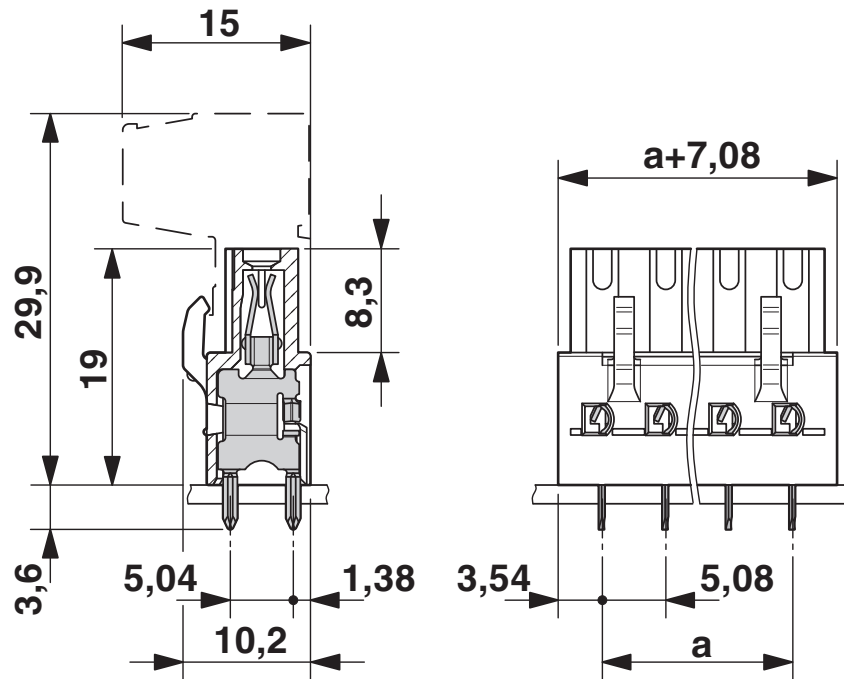

Diagram

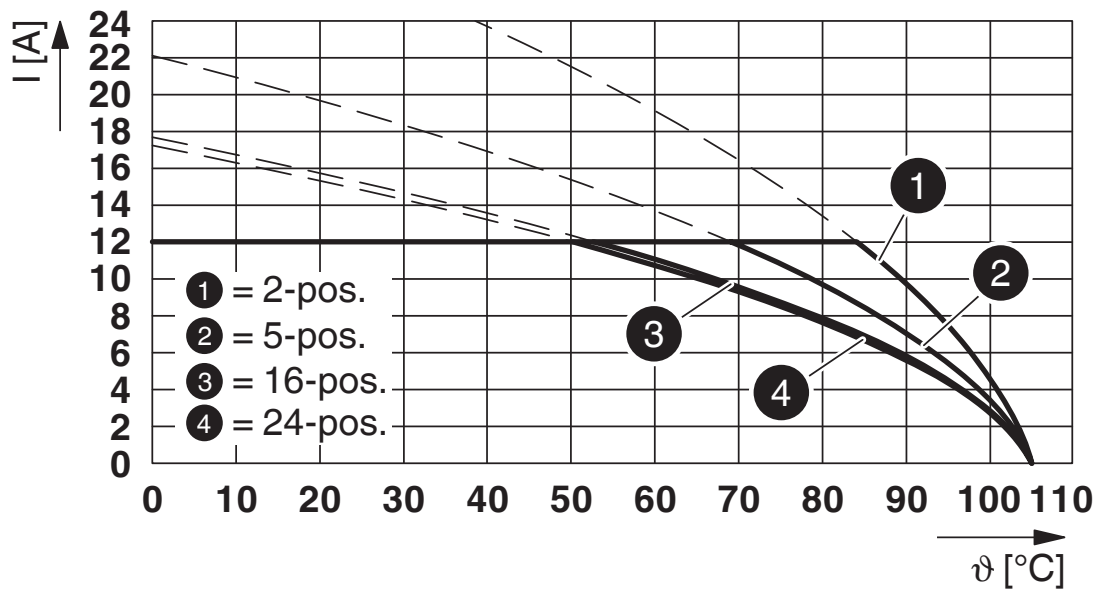

Type: ICV 2,5/...-G-5,08 with MSTB 2,5/...-G-5,08

1786051

<https://www.phoenixcontact.com/in/products/1786051>

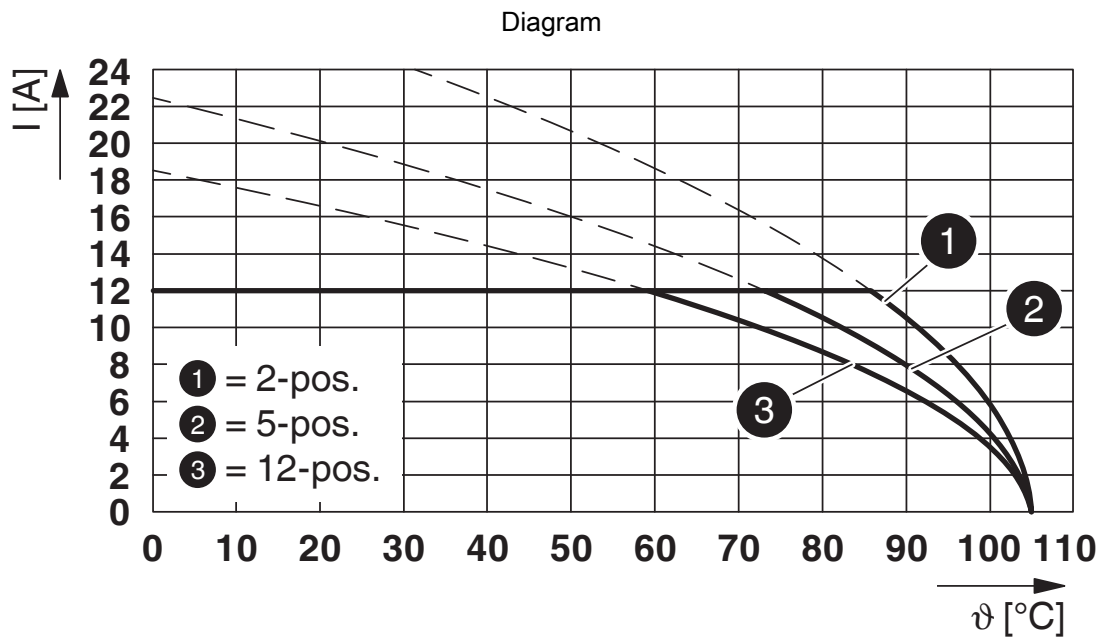

Type: ICV 2,5/...-G-5,08 with CC 2,5/...-G-5,08 P...THR

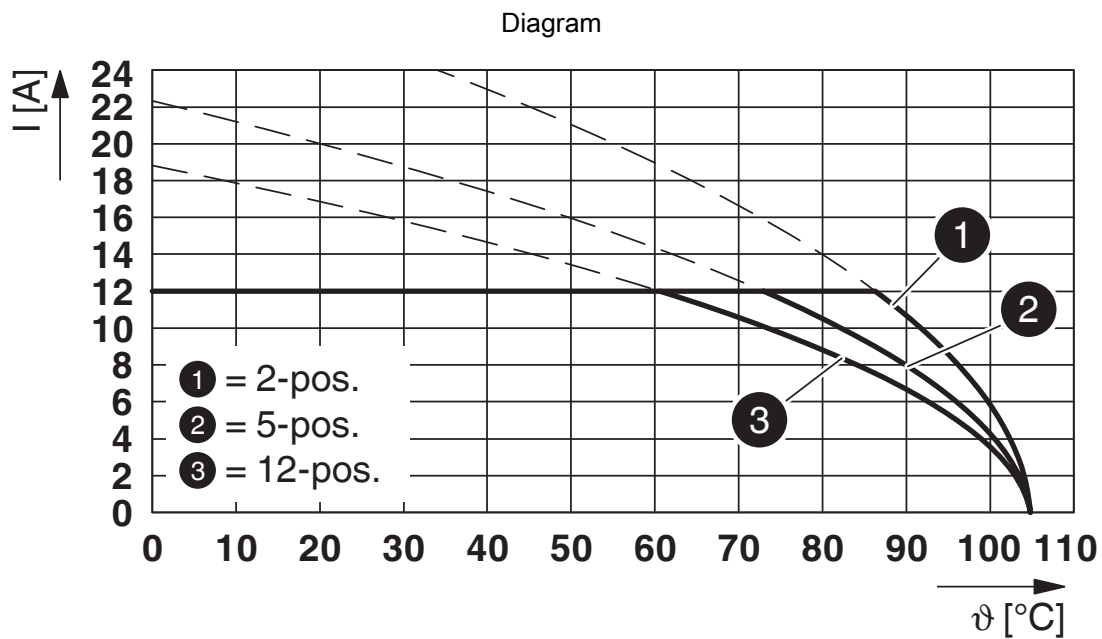

Type: ICV 2,5/...-G-5,08 with CCV 2,5/...-G-5,08 P...THR

ICV 2,5/13-G-5,08 - PCB header

1786051

<https://www.phoenixcontact.com/in/products/1786051>

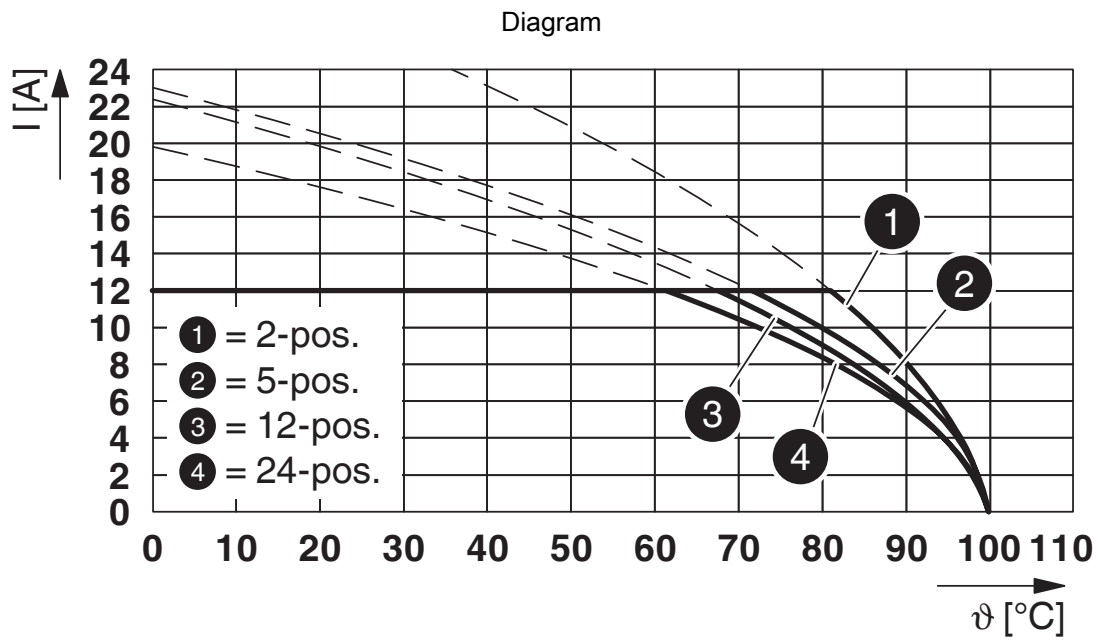

Type: IC 2,5/...-ST-5,08 with ICV 2,5/...-G-5,08

Drilling plan/solder pad geometry

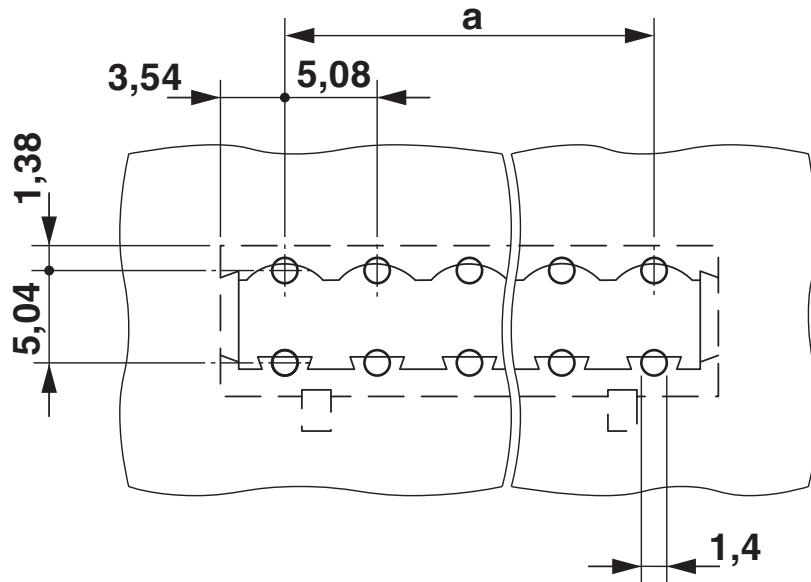

1786051

<https://www.phoenixcontact.com/in/products/1786051>

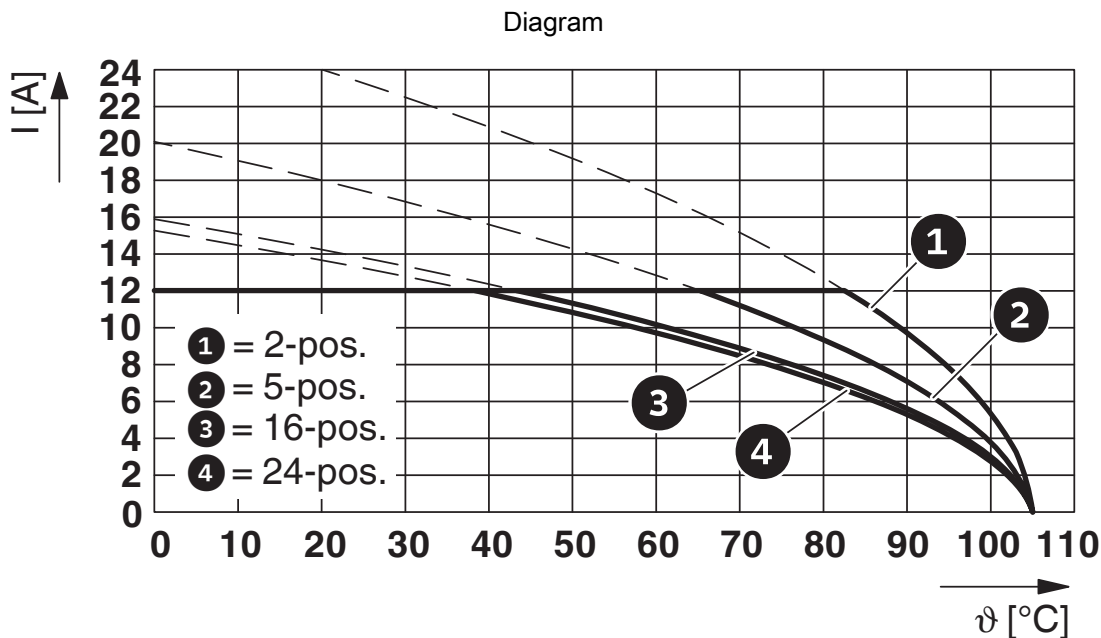

Type: ICV 2,5/...-G-5,08 with MSTBW 2,5/...-G-5,08

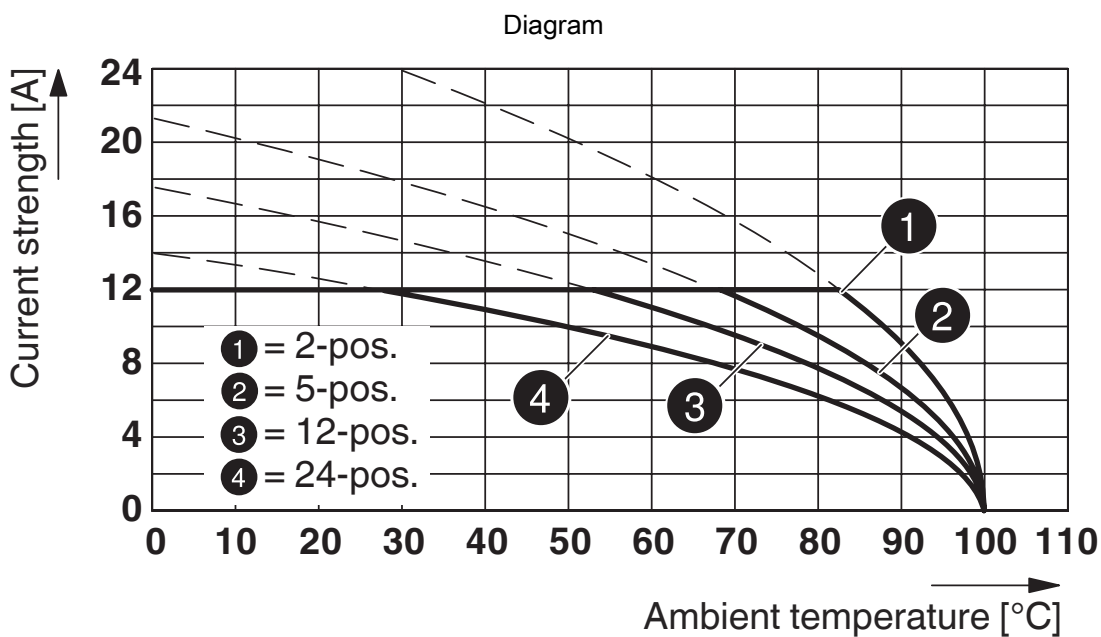

Type: ICV 2,5/...-G-5,08 with MSTBA 2,5/...-G-5,08

ICV 2,5/13-G-5,08 - PCB header

1786051

<https://www.phoenixcontact.com/in/products/1786051>

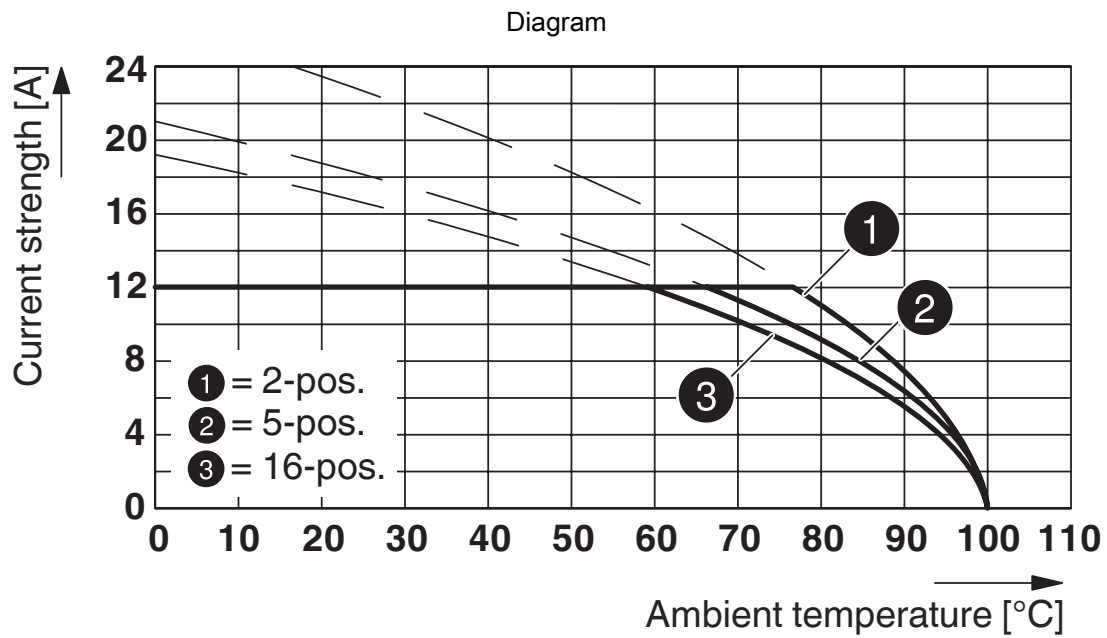

Type: FKIC 2,5/...-ST-5,08 with ICV 2,5/...-G-5,08

ICV 2,5/13-G-5,08 - PCB header



1786051

<https://www.phoenixcontact.com/in/products/1786051>

Approvals

 CSA Approval ID: 13631				
	Nominal Voltage U_N	Nominal Current I_N	Cross Section AWG	Cross Section mm^2
	300 V	10 A	-	-
	300 V	10 A	-	-

 IECEE CB Scheme Approval ID: DE1-60988-B1B2				
	Nominal Voltage U_N	Nominal Current I_N	Cross Section AWG	Cross Section mm^2
	250 V	12 A	-	-

 EAC Approval ID: B.01687				
--	--	--	--	--

 cULus Recognized Approval ID: E60425-19931014				
	Nominal Voltage U_N	Nominal Current I_N	Cross Section AWG	Cross Section mm^2
	250 V	12 A	-	-
	300 V	10 A	-	-

 VDE Zeichengenehmigung Approval ID: 40050648				
	Nominal Voltage U_N	Nominal Current I_N	Cross Section AWG	Cross Section mm^2
	250 V	12 A	-	-

ICV 2,5/13-G-5,08 - PCB header



1786051

<https://www.phoenixcontact.com/in/products/1786051>

Classifications

ECLASS

ECLASS-11.0	27460201
ECLASS-12.0	27460201
ECLASS-13.0	27460201

ETIM

ETIM 8.0	EC002637
----------	----------

UNSPSC

UNSPSC 21.0	39121400
-------------	----------

ICV 2,5/13-G-5,08 - PCB header



1786051

<https://www.phoenixcontact.com/in/products/1786051>

Environmental Product Compliance

China RoHS	Environmentally friendly use period: unlimited = EFUP-e No hazardous substances above threshold values
------------	---

ICV 2,5/13-G-5,08 - PCB header

1786051

<https://www.phoenixcontact.com/in/products/1786051>



Accessories

MPS-MT - Test plugs

0201744

<https://www.phoenixcontact.com/in/products/0201744>



Test plugs, with solder connection up to 1 mm² conductor cross section, number of positions: 1, fuse type: , mounting type: , , color: gray

RPS - Reducing plug

0201647

<https://www.phoenixcontact.com/in/products/0201647>



Reducing plug, number of positions: 1, fuse type: , mounting type: , , color: gray

ICV 2,5/13-G-5,08 - PCB header

1786051

<https://www.phoenixcontact.com/in/products/1786051>

CP-MSTB - Coding profile

1734634

<https://www.phoenixcontact.com/in/products/1734634>

Coding profile, is inserted into the slot on the plug or inverted header, red insulating material



FLRP/ICV 80 - Mounting material

1808353

<https://www.phoenixcontact.com/in/products/1808353>

Pair of guide rails, is inserted into the groove ICV/...G, height: 86 mm, hole diameter: 3.4 mm



ICV 2,5/13-G-5,08 - PCB header

1786051

<https://www.phoenixcontact.com/in/products/1786051>



IC 2,5/13-ST-5,08 - PCB connector

1786284

<https://www.phoenixcontact.com/in/products/1786284>



PCB connector, nominal cross section: 2.5 mm², color: green, nominal current: 12 A, rated voltage (III/2): 320 V, contact surface: Tin, type of contact: Pin, number of potentials: 13, number of rows: 1, number of positions: 13, number of connections: 13, product range: IC 2,5/...-ST, pitch: 5.08 mm, connection method: Screw connection with tension sleeve, screw head form: L Slotted, conductor/PCB connection direction: 0 °, locking clip: - without locking clip, plug-in system: COMBICON MSTB 2,5, locking: without, mounting: without, type of packaging: packed in cardboard

MSTBW 2,5/13-G-5,08 - PCB header

1735772

<https://www.phoenixcontact.com/in/products/1735772>

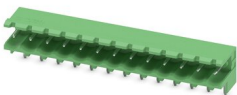

PCB headers, nominal cross section: 2.5 mm², color: green, nominal current: 12 A, rated voltage (III/2): 320 V, contact surface: Tin, type of contact: Pin, number of potentials: 13, number of rows: 1, number of positions: 13, number of connections: 13, product range: MSTBW 2,5/...-G, pitch: 5.08 mm, mounting: Wave soldering, pin layout: Linear pinning, solder pin [P]: 3.5 mm, number of solder pins per potential: 1, plug-in system: COMBICON MSTB 2,5, Pin connector pattern alignment: Standard, locking: without, mounting: without, type of packaging: packed in cardboard

ICV 2,5/13-G-5,08 - PCB header

1786051

<https://www.phoenixcontact.com/in/products/1786051>



FKIC 2,5/13-ST-5,08 - PCB connector

1873469

<https://www.phoenixcontact.com/in/products/1873469>

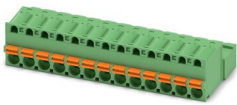

PCB connector, nominal cross section: 2.5 mm², color: green, nominal current: 12 A, rated voltage (III/2): 320 V, contact surface: Tin, type of contact: Pin, number of potentials: 13, number of rows: 1, number of positions: 13, number of connections: 13, product range: FKIC 2,5/..-ST, pitch: 5.08 mm, connection method: Push-in spring connection, conductor/PCB connection direction: 0 °, locking clip: - without locking clip, plug-in system: COMBICON MSTB 2,5, locking: without, mounting: without, type of packaging: packed in cardboard

MDSTB 2,5/13-G1-5,08 - PCB header

1762473

<https://www.phoenixcontact.com/in/products/1762473>

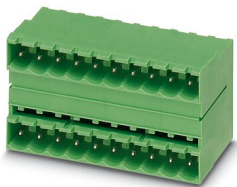

PCB headers, nominal cross section: 2.5 mm², color: green, nominal current: 10 A, rated voltage (III/2): 320 V, contact surface: Tin, type of contact: Pin, number of potentials: 26, number of rows: 2, number of positions: 13, number of connections: 26, product range: MDSTB 2,5/..-G1, pitch: 5.08 mm, mounting: Wave soldering, pin layout: Linear pinning, solder pin [P]: 3.5 mm, number of solder pins per potential: 1, plug-in system: COMBICON MSTB 2,5, Pin connector pattern alignment: Standard, locking: without, mounting: without, type of packaging: packed in cardboard, In combination with MVSTB or FKCV plug components, both an MVSTBW (or FKCVW) and an MVSTBR plug (or FKCVR) must be used. Combination with TMSTBP plug components is not possible!

ICV 2,5/13-G-5,08 - PCB header

1786051

<https://www.phoenixcontact.com/in/products/1786051>



SMSTBA 2,5/13-G-5,08 - PCB header

1767481

<https://www.phoenixcontact.com/in/products/1767481>



PCB headers, nominal cross section: 2.5 mm², color: green, nominal current: 12 A, rated voltage (III/2): 320 V, contact surface: Tin, type of contact: Pin, number of potentials: 13, number of rows: 1, number of positions: 13, number of connections: 13, product range: SMSTBA 2,5/..-G, pitch: 5.08 mm, mounting: Wave soldering, pin layout: Linear pinning, solder pin [P]: 3.5 mm, number of solder pins per potential: 1, plug-in system: COMBICON MSTB 2,5, Pin connector pattern alignment: Standard, locking: without, mounting: without, type of packaging: packed in cardboard

SMSTB 2,5/13-G-5,08 - PCB header

1769573

<https://www.phoenixcontact.com/in/products/1769573>



PCB headers, nominal cross section: 2.5 mm², color: green, nominal current: 12 A, rated voltage (III/2): 320 V, contact surface: Tin, type of contact: Pin, number of potentials: 13, number of rows: 1, number of positions: 13, number of connections: 13, product range: SMSTB 2,5/..-G, pitch: 5.08 mm, mounting: Wave soldering, pin layout: Linear pinning, solder pin [P]: 3.5 mm, number of solder pins per potential: 1, plug-in system: COMBICON MSTB 2,5, Pin connector pattern alignment: Standard, locking: without, mounting: without, type of packaging: packed in cardboard

ICV 2,5/13-G-5,08 - PCB header

1786051

<https://www.phoenixcontact.com/in/products/1786051>



ICC 2,5/13-STZ-5,08 - PCB connector

1823956

<https://www.phoenixcontact.com/in/products/1823956>



PCB connector, nominal cross section: 2.5 mm², color: green, nominal current: 12 A, rated voltage (III/2): 320 V, type of contact: Pin, number of potentials: 13, number of rows: 1, number of positions: 13, number of connections: 13, product range: ICC 2,5/...-STZ, pitch: 5.08 mm, connection method: Crimp connection, conductor/PCB connection direction: 0 °, locking clip: - without locking clip, plug-in system: COMBICON MSTB 2,5, locking: Snap-in locking, mounting: Engagement nose, type of packaging: packed in cardboard, Corresponding male crimp contacts with current [A] and conductor cross section range [mm²] data: 10A/ICC-MT 0,5-1,0 (3190577); 10A/ICC-MT 0,5-1,0 BA (3190603); 12A/ICC-MT 1,5-2,5 (3190580); 12A/ICC-MT 1,5-2,5 BA (3190593). BA = Bandkontakte

Phoenix Contact 2023 © - all rights reserved

<https://www.phoenixcontact.com>

PHOENIX CONTACT (I) Pvt. Ltd.

A-58/2, Okhla Industrial Area, Phase - II, New Delhi-110 020

+91.1275.71420

info@phoenixcontact.co.in