

REL-MR- 12DC/21-21 - Single relay



2961257

<https://www.phoenixcontact.com/in/products/2961257>

Please be informed that the data shown in this PDF document is generated from our Online Catalog. Please find the complete data in the user documentation. Our General Terms of Use for Downloads are valid.

Plug-in miniature power relay, with power contact, 2 changeover contacts, input voltage 12 V DC

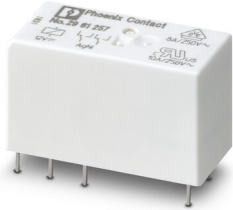

Your advantages

- RT III-proof (wash-proof)
- Switching current of up to 8 A

Commercial Data

Item number	2961257
Packing unit	10 pc
Minimum order quantity	10 pc
Sales Key	CK6
Product Key	CK6195
Catalog Page	Page 290 (C-5-2019)
GTIN	4017918163525
Weight per Piece (including packing)	16.24 g
Weight per Piece (excluding packing)	15.43 g
Customs tariff number	85364900
Country of origin	AT

Technical Data

Product properties

Product type	Single relay
Set comprises	2967235 PLC-RSC- 12DC/21-21
	2912497 PLC-RSP- 12DC/21-21
	2900329 PLC-RPT- 12DC/21-21
	2987105 PLC-RSP- 24UC/21-21/RW
	2900346 PLC-RPT- 24UC/21-21/RW
	2906223 RIF-1-RPT-LDP-12DC/2X21
	2908501 RIF-1-RSC-LDP-12DC/2X21
Operating mode	100% operating factor
Mechanical service life	3x 10 ⁷ cycles

Insulation characteristics

Insulation	Basic insulation
------------	------------------

Insulation characteristics

Insulation	Basic insulation
Overvoltage category	III
Pollution degree	3

Electrical properties

Service life electrical	see diagram
Maximum power dissipation for nominal condition	0.4 W
Test voltage (Winding/contact)	5 kV AC (50 Hz, 1 min., winding/contact)
Test voltage (Contact/contact)	2.5 kV AC (50 Hz, 1 min., contact/contact)

Input data

Coil side

Nominal input voltage U_N	12 V DC
Input voltage range	7.8 V DC ... 29.76 V DC
Input voltage range in reference to U_N	see diagram
Typical input current at U_N	33 mA
Typical response time	7 ms
Typical release time	3 ms
Coil resistance	360 Ω \pm 10 % (at 20 °C)

Output data

Switching

Contact type	2 changeover contacts
Type of switch contact	Single contact
Drive and function	monostable

REL-MR- 12DC/21-21 - Single relay

2961257

<https://www.phoenixcontact.com/in/products/2961257>

Drive (polarity)	bipolar
Contact material	AgNi
Maximum switching voltage	250 V AC/DC
Minimum switching voltage	5 V (at 10 mA)
Limiting continuous current	8 A
Maximum inrush current	25 A (20 ms)
Min. switching current	10 mA (At 5 V)
Interrupting rating (ohmic load) max.	190 W (at 24 V DC) 85 W (at 48 V DC) 60 W (at 60 V DC) 44 W (at 110 V DC) 60 W (at 220 V DC) 2000 VA (for 250 V AC)
Switching capacity	2 A (at 24 V, DC13) 0.2 A (at 250 V, DC13) 3 A (at 24 V, AC15) 3 A (at 120 V, AC15) 3 A (at 250 V, AC15)
Motor load according to UL 508	1/4 HP, 120 V AC 1/2 HP, 240 V AC

Connection data

Connection method	Plug / solder connection
-------------------	--------------------------

Dimensions

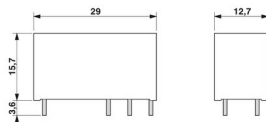
Dimensional drawing	
Width	12.7 mm
Height	29 mm
Depth	15.7 mm

Environmental and real-life conditions

Ambient conditions

Degree of protection	RT III
Ambient temperature (operation)	-40 °C ... 85 °C
Ambient temperature (storage/transport)	-40 °C ... 85 °C

Approvals

Corrosive gas test

Identification	ISA-S71.04. G3 Harsh Group
----------------	----------------------------

REL-MR- 12DC/21-21 - Single relay



2961257

<https://www.phoenixcontact.com/in/products/2961257>

	EN 60068-2-60
--	---------------

Standards and regulations

Standards/regulations	IEC 60664
	EN 50178
	EN 61810-1

Mounting

Assembly instructions	Can be aligned without spacing ($> 70\text{ °C} \geq 2.5\text{ mm}$)
Mounting position	any

Drawings

Diagram

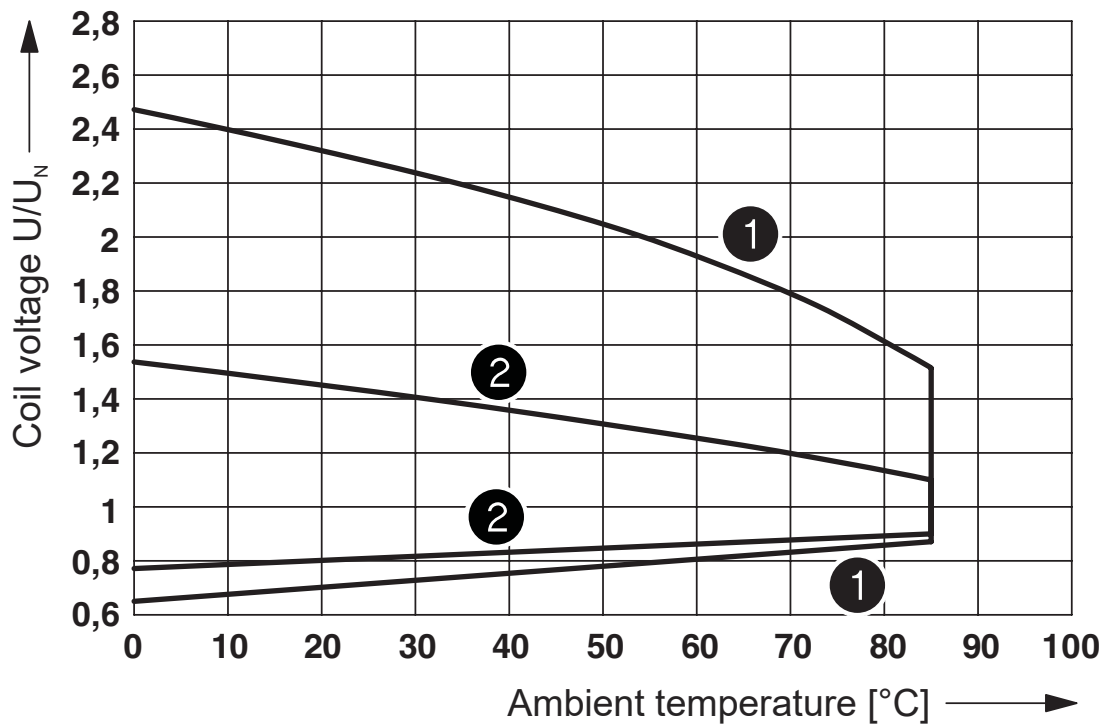

- ① DC coils
- ② AC coils

Operating voltage range

Dimensional drawing

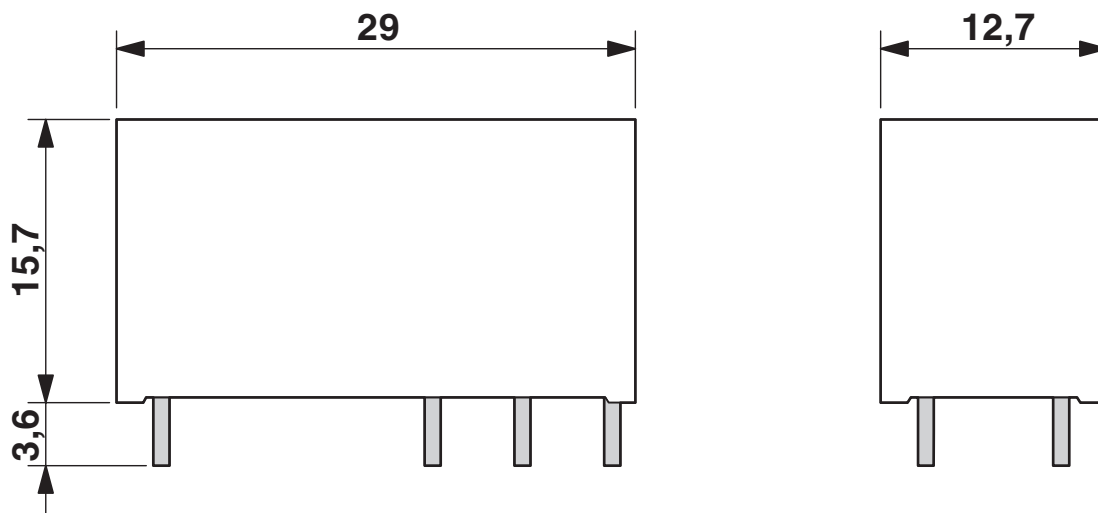

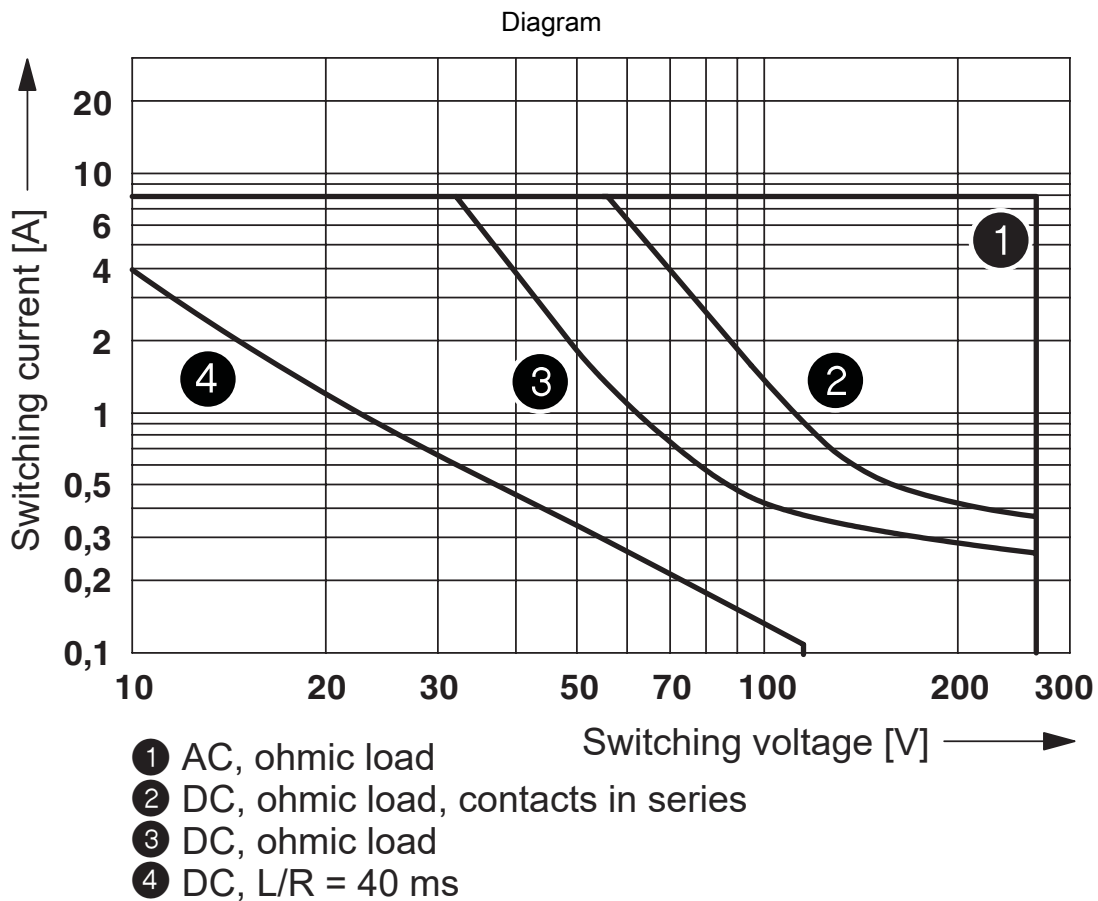

Interrupting rating

Diagram

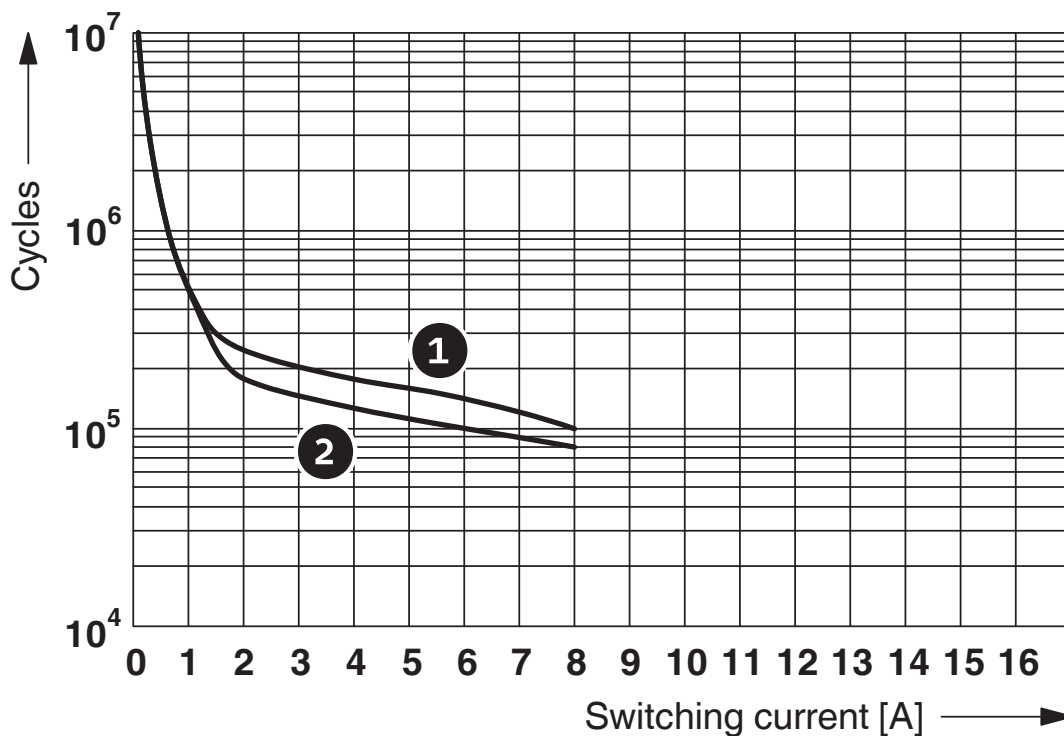

- ① 250 V AC, ohmic load (DC coils)
- ② 250 V AC, ohmic load (AC coils)

Electrical service life

Circuit diagram

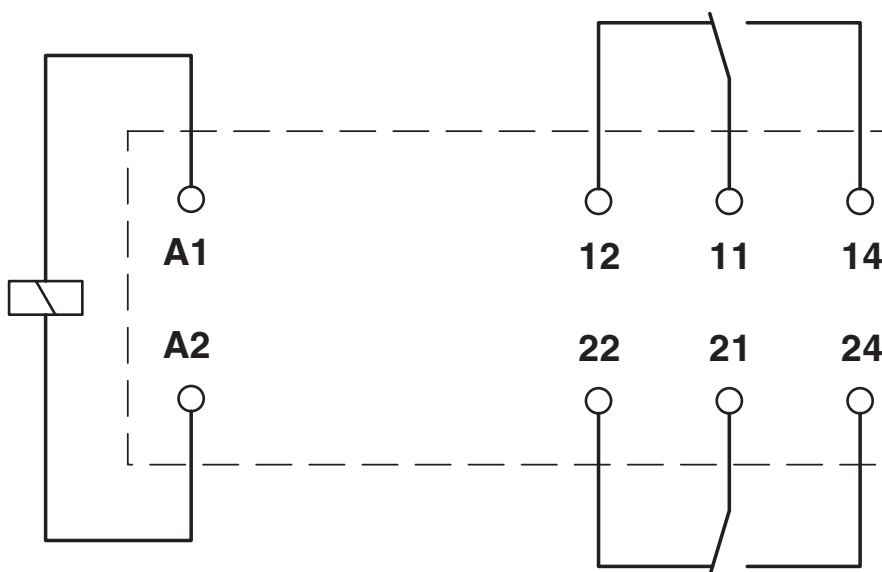

Diagram

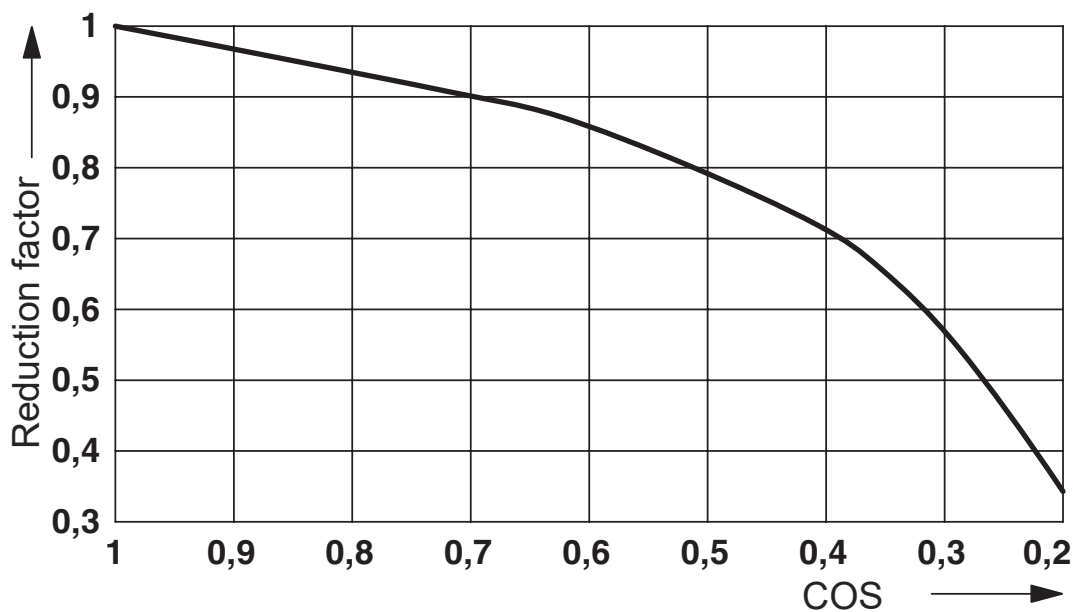

Service life reduction factor with various cos phi

Drilling plan/solder pad geometry

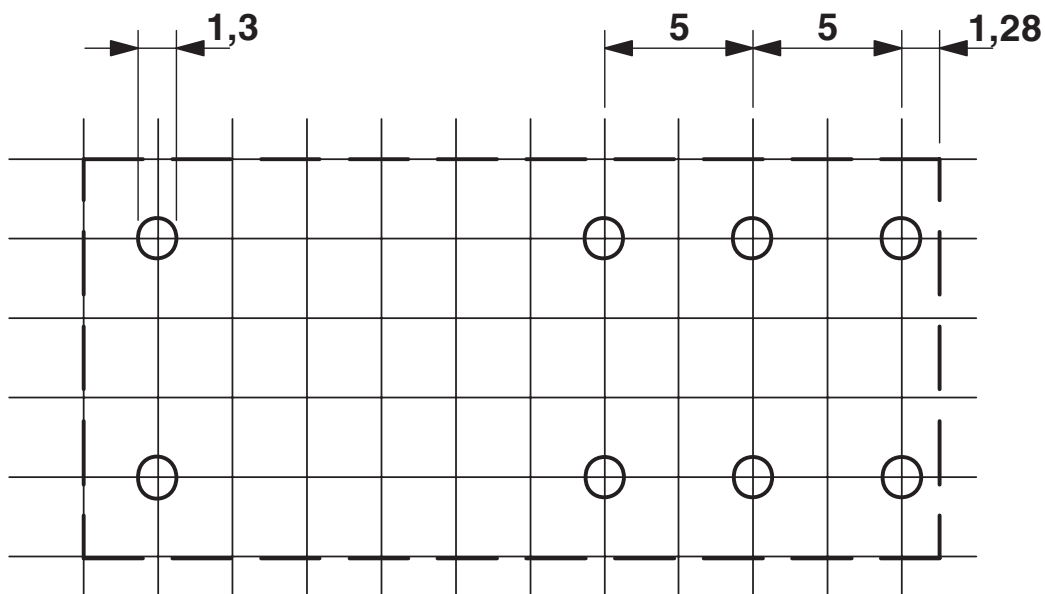

a = pitch division 2.5 mm

REL-MR- 12DC/21-21 - Single relay



2961257

<https://www.phoenixcontact.com/in/products/2961257>

Approvals



cUL Recognized
Approval ID: FILE E 228652



UL Recognized
Approval ID: FILE E 228652



EAC
Approval ID: TR_TS_D_00573_c



UL Recognized
Approval ID: FILE E 228652



EAC
Approval ID: RU*C-DE.*08.B.00010



VDE Zeichengenehmigung
Approval ID: 40007758



VDE Zeichengenehmigung
Approval ID: 40048281



PRS
Approval ID: TE/2109/880590/16



cUL Recognized
Approval ID: FILE E 228652



cUL Recognized
Approval ID: FILE E 172140



UL Recognized
Approval ID: FILE E 172140

REL-MR- 12DC/21-21 - Single relay



2961257

<https://www.phoenixcontact.com/in/products/2961257>

Classifications

ECLASS

ECLASS-11.0	27371601
ECLASS-12.0	27371601
ECLASS-13.0	27371601

ETIM

ETIM 8.0	EC001437
----------	----------

UNSPSC

UNSPSC 21.0	39122300
-------------	----------

REL-MR- 12DC/21-21 - Single relay



2961257

<https://www.phoenixcontact.com/in/products/2961257>

Environmental Product Compliance

China RoHS	Environmentally friendly use period: unlimited = EFUP-e
	No hazardous substances above threshold values

REL-MR- 12DC/21-21 - Single relay

2961257

<https://www.phoenixcontact.com/in/products/2961257>

Accessories

PLC-BPT- 12DC/21-21 - Relay base

2900282

<https://www.phoenixcontact.com/in/products/2900282>



14 mm PLC basic terminal block with Push-in connection, without relay or solid-state relay, for mounting on DIN rail NS 35/7,5, 2 changeover contacts, input voltage 12 V DC

PLC-BSC- 12DC/21-21 - Relay base

2967251

<https://www.phoenixcontact.com/in/products/2967251>



14 mm PLC basic terminal block with screw connection, without relay or solid-state relay, for mounting on DIN rail NS 35/7,5, 2 changeover contacts, input voltage 12 V DC

REL-MR- 12DC/21-21 - Single relay



2961257

<https://www.phoenixcontact.com/in/products/2961257>

RIF-1-BPT/2X21 - Relay base

2900931

<https://www.phoenixcontact.com/in/products/2900931>



Relay base RIF-1..., for miniature power relay with 1 or 2 changeover contacts or solid-state relays of the same design, Push-in connection, plug-in option for input/interference suppression modules, for mounting on NS 35/7,5

RIF-1-BSC/2X21 - Relay base

2900930

<https://www.phoenixcontact.com/in/products/2900930>



RIF-1... relay base, for miniature power relay with 1 or 2 changeover contacts or identical solid-state relays, screw connection, plug-in option for input/interference suppression modules, for mounting on NS 35/7,5

Phoenix Contact 2023 © - all rights reserved
<https://www.phoenixcontact.com>

PHOENIX CONTACT (I) Pvt. Ltd.
A-58/2, Okhla Industrial Area, Phase - II, New Delhi-110 020

+91.1275.71420
info@phoenixcontact.co.in