

MSTBO 2,5/ 5-GL-5,08 - PCB header



1850466

<https://www.phoenixcontact.com/in/products/1850466>

Please be informed that the data shown in this PDF document is generated from our Online Catalog. Please find the complete data in the user documentation. Our General Terms of Use for Downloads are valid.



PCB headers, nominal cross section: 2.5 mm², color: green, nominal current: 8 A, rated voltage (III/2): 320 V, contact surface: Tin, type of contact: Pin, number of potentials: 5, number of rows: 1, number of positions: 5, number of connections: 5, product range: MSTBO 2,5/...-GL, pitch: 5.08 mm, mounting: Wave soldering, pin layout: Linear pinning, solder pin [P]: 3.2 mm, number of solder pins per potential: 1, plug-in system: COMBICON MSTB 2,5, locking: without, mounting: without, type of packaging: packed in cardboard

Your advantages

- Well-known mounting principle allows worldwide use
- Can be combined with the MSTB 2,5 range
- Maximum flexibility when it comes to device design – one header for connectors with different connection technologies

Commercial Data

| | |
|--------------------------------------|---------------------|
| Item number | 1850466 |
| Packing unit | 50 pc |
| Minimum order quantity | 50 pc |
| Sales Key | AAC |
| Product Key | AACSKA |
| Catalog Page | Page 320 (C-1-2013) |
| GTIN | 4017918102890 |
| Weight per Piece (including packing) | 4.118 g |
| Weight per Piece (excluding packing) | 4.118 g |
| Customs tariff number | 85366930 |
| Country of origin | PL |

MSTBO 2,5/ 5-GL-5,08 - PCB header



1850466

<https://www.phoenixcontact.com/in/products/1850466>

Technical Data

Product properties

| | |
|---------------------------|---------------------------------|
| Type | Header perpendicular to the PCB |
| Product line | COMBICON Connectors M |
| Product type | PCB headers |
| Product family | MSTBO 2,5/..-GL |
| Number of positions | 5 |
| Pitch | 5.08 mm |
| Number of connections | 5 |
| Number of rows | 1 |
| Mounting flange | without |
| Number of potentials | 5 |
| Pin layout | Linear pinning |
| Solder pins per potential | 1 |

Electrical properties

| | |
|-----------------------------|-------|
| Nominal current I_N | 8 A |
| Nominal voltage U_N | 320 V |
| Degree of pollution | 3 |
| Rated voltage (III/3) | 250 V |
| Rated surge voltage (III/3) | 4 kV |
| Rated voltage (III/2) | 320 V |
| Rated surge voltage (III/2) | 4 kV |
| Rated voltage (II/2) | 630 V |
| Rated surge voltage (II/2) | 4 kV |

Mounting

| | |
|---------------|----------------|
| Mounting type | Wave soldering |
| Pin layout | Linear pinning |

Material specifications

Material data - contact

| | |
|--|--|
| Note | WEEE/RoHS-compliant, free of whiskers according to IEC 60068-2-82/JEDEC JESD 201 |
| Contact material | Cu alloy |
| Surface characteristics | hot-dip tin-plated |
| Metal surface contact area (top layer) | Tin (5 - 7 μm Sn) |
| Metal surface soldering area (top layer) | Tin (5 - 7 μm Sn) |

Material data - housing

| | |
|---------------------------|--------------|
| Color (Housing) | green (6021) |
| Insulating material | PA |
| Insulating material group | I |

MSTBO 2,5/ 5-GL-5,08 - PCB header

1850466

<https://www.phoenixcontact.com/in/products/1850466>

| | |
|---|--------|
| CTI according to IEC 60112 | 600 |
| Flammability rating according to UL 94 | V0 |
| Glow wire flammability index GWFI according to EN 60695-2-12 | 850 |
| Glow wire ignition temperature GWIT according to EN 60695-2-13 | 775 |
| Temperature for the ball pressure test according to EN 60695-10-2 | 125 °C |

Material data – actuating element

| | |
|----------|----|
| Color () | () |
|----------|----|

Notes

| | |
|--------------------|--|
| Notes on operation | In accordance with IEC 61984, COMBICON connectors have no switching power (COC). During designated use, they must not be plugged in or disconnected when carrying voltage or under load. |
|--------------------|--|

Dimensions

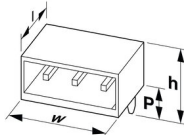
| | |
|-----------------------|--|
| Dimensional drawing |  |
| Pitch | 5.08 mm |
| Width [w] | 25.4 mm |
| Height [h] | 23.62 mm |
| Length [l] | 44.06 mm |
| Installed height | 20.42 mm |
| Solder pin length [P] | 3.2 mm |

Electrical tests

Air clearances and creepage distances |

| | |
|----------------------------------|-------|
| Insulating material group | I |
| Rated insulation voltage (III/3) | 250 V |
| Rated surge voltage (III/3) | 4 kV |
| Rated insulation voltage (III/2) | 320 V |
| Rated surge voltage (III/2) | 4 kV |
| Rated insulation voltage (II/2) | 630 V |
| Rated surge voltage (II/2) | 4 kV |

Environmental and real-life conditions

Ambient conditions

| | |
|---|---|
| Ambient temperature (operation) | -40 °C ... 100 °C (dependent on the derating curve) |
| Ambient temperature (storage/transport) | -40 °C ... 70 °C |
| Relative humidity (storage/transport) | 30 % ... 70 % |

MSTBO 2,5/ 5-GL-5,08 - PCB header



1850466

<https://www.phoenixcontact.com/in/products/1850466>

| | |
|--------------------------------|------------------|
| Ambient temperature (assembly) | -5 °C ... 100 °C |
|--------------------------------|------------------|

Packaging specifications

| | |
|-------------------|---------------------|
| Type of packaging | packed in cardboard |
|-------------------|---------------------|

MSTBO 2,5/ 5-GL-5,08 - PCB header



1850466

<https://www.phoenixcontact.com/in/products/1850466>

Drawings

Dimensional drawing

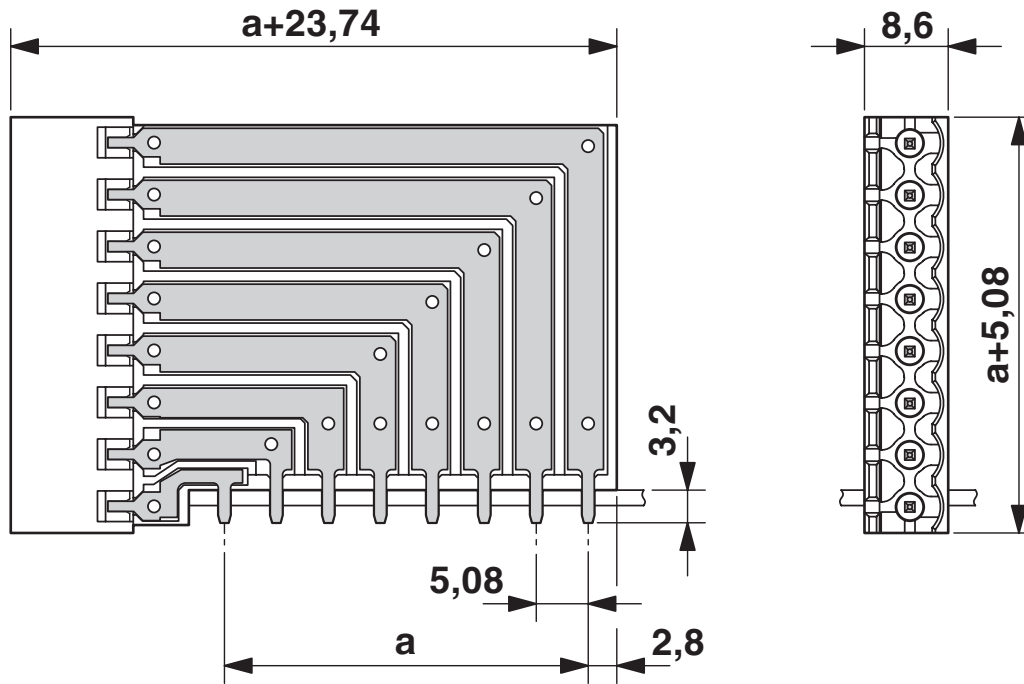

Drilling plan/solder pad geometry

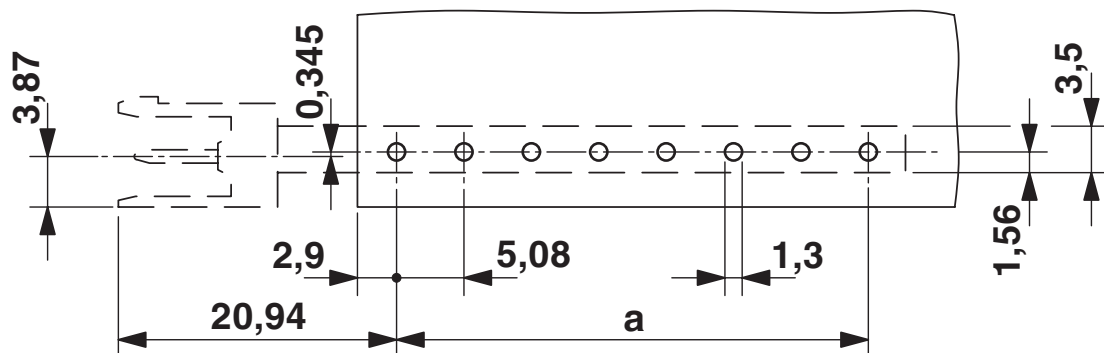

MSTBO 2,5/ 5-GL-5,08 - PCB header

1850466

<https://www.phoenixcontact.com/in/products/1850466>

Diagram

Plug: MSTB 2,5/5-ST(F)(-5,08)
Header: MSTBO 2,5/5-GR(L)(-5,08)

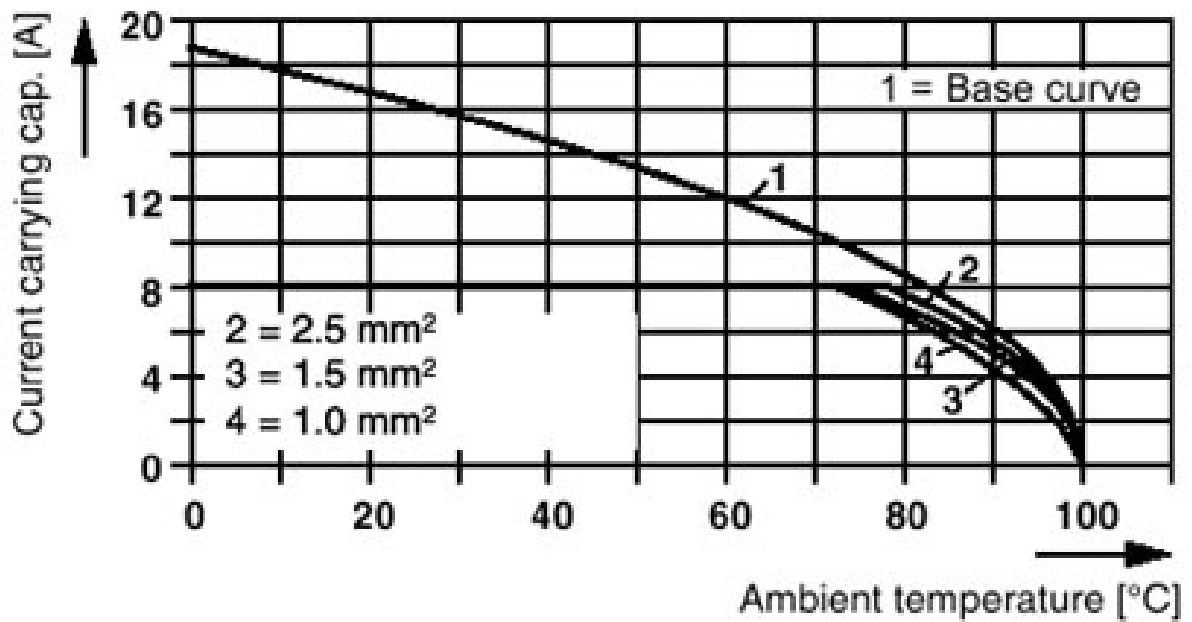

MSTBO 2,5/ 5-GL-5,08 - PCB header



1850466

<https://www.phoenixcontact.com/in/products/1850466>

Approvals

|  CSA Approval ID: 13631 | | | | |
|--|-----------------------|-----------------------|-------------------|-----------------------------|
| | Nominal Voltage U_N | Nominal Current I_N | Cross Section AWG | Cross Section mm^2 |
| | 300 V | 6.5 A | - | - |
| | 300 V | 6.5 A | - | - |

|  IECEE CB Scheme Approval ID: DE1-60988-B1B2 | | | | |
|---|-----------------------|-----------------------|-------------------|-----------------------------|
| | Nominal Voltage U_N | Nominal Current I_N | Cross Section AWG | Cross Section mm^2 |
| | 250 V | 8 A | - | - |

|  EAC Approval ID: B.01687 | | | | |
|--|--|--|--|--|
|--|--|--|--|--|

|  cULus Recognized Approval ID: E60425-20050718 | | | | |
|---|-----------------------|-----------------------|-------------------|-----------------------------|
| | Nominal Voltage U_N | Nominal Current I_N | Cross Section AWG | Cross Section mm^2 |
| | 250 V | 8 A | - | - |
| | 300 V | 8 A | - | - |

|  VDE Zeichengenehmigung Approval ID: 40050648 | | | | |
|--|-----------------------|-----------------------|-------------------|-----------------------------|
| | Nominal Voltage U_N | Nominal Current I_N | Cross Section AWG | Cross Section mm^2 |
| | 250 V | 8 A | - | - |

MSTBO 2,5/ 5-GL-5,08 - PCB header



1850466

<https://www.phoenixcontact.com/in/products/1850466>

Classifications

ECLASS

| | |
|-------------|----------|
| ECLASS-11.0 | 27460201 |
| ECLASS-12.0 | 27460201 |
| ECLASS-13.0 | 27460201 |

ETIM

| | |
|----------|----------|
| ETIM 8.0 | EC002637 |
|----------|----------|

UNSPSC

| | |
|-------------|----------|
| UNSPSC 21.0 | 39121400 |
|-------------|----------|

MSTBO 2,5/ 5-GL-5,08 - PCB header



1850466

<https://www.phoenixcontact.com/in/products/1850466>

Environmental Product Compliance

| | |
|------------|---|
| China RoHS | Environmentally friendly use period: unlimited = EFUP-e |
| | No hazardous substances above threshold values |

MSTBO 2,5/ 5-GL-5,08 - PCB header

1850466

<https://www.phoenixcontact.com/in/products/1850466>

Accessories

CR-MSTB - Coding section

1734401

<https://www.phoenixcontact.com/in/products/1734401>

Coding section, inserted into the recess in the header or the inverted plug, red insulating material



SK 5,08/3,8:FORTL.ZAHLEN - Marker card

0804293

<https://www.phoenixcontact.com/in/products/0804293>

Marker card, white, labeled, horizontal: consecutive numbers 1 ... 10, 11 ... 20, etc. up to 91 ... (99)100, mounting type: adhesive, for terminal block width: 5.08 mm, lettering field size: 5.08 x 3.8 mm



MSTBO 2,5/ 5-GL-5,08 - PCB header

1850466

<https://www.phoenixcontact.com/in/products/1850466>



SK 5,08/3,8:UNBEDRUCKT - Marker card

0805412

<https://www.phoenixcontact.com/in/products/0805412>

Marker card, white, unlabeled, can be labeled with: Marker pen, mounting type: adhesive, for terminal block width: 5.08 mm, lettering field size: 5.08 x 3.8 mm



MSTB-BL - Accessories

1755477

<https://www.phoenixcontact.com/in/products/1755477>

Keying cap, for forming sections, plugs onto header pin, green insulating material



MSTBO 2,5/ 5-GL-5,08 - PCB header

1850466

<https://www.phoenixcontact.com/in/products/1850466>



B-STIFT - Marker pen

1051993

<https://www.phoenixcontact.com/in/products/1051993>



Marker pen, for manual labeling of unprinted Zack strips, smear-proof and waterproof, line thickness 0.5 mm

TVMSTB 2,5/ 5-ST-5,08 - PCB connector

1719037

<https://www.phoenixcontact.com/in/products/1719037>



PCB connector, nominal cross section: 2.5 mm², color: green, nominal current: 12 A, rated voltage (III/2): 400 V, contact surface: Tin, type of contact: Socket, number of potentials: 5, number of rows: 1, number of positions: 5, number of connections: 10, product range: TVMSTB 2,5/..-ST, pitch: 5.08 mm, connection method: Screw connection with tension sleeve, screw head form: L Slotted, conductor/PCB connection direction: 90 °, locking clip: - Locking clip, plug-in system: COMBICON MSTB 2,5, locking: without, mounting: without, type of packaging: packed in cardboard

MSTBO 2,5/ 5-GL-5,08 - PCB header

1850466

<https://www.phoenixcontact.com/in/products/1850466>



FKCN 2,5/ 5-ST-5,08 - PCB connector

1754597

<https://www.phoenixcontact.com/in/products/1754597>

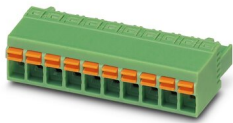

PCB connector, nominal cross section: 2.5 mm², color: green, nominal current: 12 A, rated voltage (III/2): 320 V, contact surface: Tin, type of contact: Socket, number of potentials: 5, number of rows: 1, number of positions: 5, number of connections: 5, product range: FKCN 2,5/..-ST, pitch: 5.08 mm, connection method: Push-in spring connection, conductor/PCB connection direction: 0 °, locking clip: - Locking clip, plug-in system: COMBICON MSTB 2,5, locking: without, mounting: without, type of packaging: packed in cardboard

MSTB 2,5/ 5-ST-5,08 - PCB connector

1757048

<https://www.phoenixcontact.com/in/products/1757048>

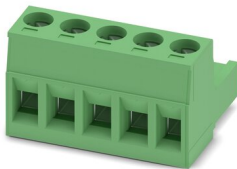

PCB connector, nominal cross section: 2.5 mm², color: green, nominal current: 12 A, rated voltage (III/2): 320 V, contact surface: Tin, type of contact: Socket, number of potentials: 5, number of rows: 1, number of positions: 5, number of connections: 5, product range: MSTB 2,5/..-ST, pitch: 5.08 mm, connection method: Screw connection with tension sleeve, screw head form: L Slotted, conductor/PCB connection direction: 0 °, locking clip: - Locking clip, plug-in system: COMBICON MSTB 2,5, locking: without, mounting: without, type of packaging: packed in cardboard

MSTBO 2,5/ 5-GL-5,08 - PCB header

1850466

<https://www.phoenixcontact.com/in/products/1850466>



FRONT-MSTB 2,5/ 5-ST-5,08 - PCB connector

1777316

<https://www.phoenixcontact.com/in/products/1777316>

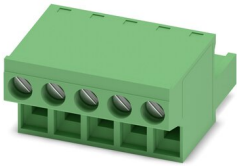

PCB connector, nominal cross section: 2.5 mm², color: green, nominal current: 12 A, rated voltage (III/2): 320 V, contact surface: Tin, type of contact: Socket, number of potentials: 5, number of rows: 1, number of positions: 5, number of connections: 5, product range: FRONT-MSTB 2,5/...-ST, pitch: 5.08 mm, connection method: Front screw connection, screw head form: L Slotted, conductor/PCB connection direction: 0 °, locking clip: - Locking clip, plug-in system: COMBICON MSTB 2,5, locking: without, mounting: without, type of packaging: packed in cardboard

MSTBT 2,5/ 5-ST-5,08 - PCB connector

1781014

<https://www.phoenixcontact.com/in/products/1781014>



PCB connector, nominal cross section: 2.5 mm², color: green, nominal current: 12 A, rated voltage (III/2): 320 V, contact surface: Tin, type of contact: Socket, number of potentials: 5, number of rows: 1, number of positions: 5, number of connections: 5, product range: MSTBT 2,5/...-ST, pitch: 5.08 mm, connection method: Screw connection with tension sleeve, screw head form: L Slotted, conductor/PCB connection direction: 0 °, locking clip: - Locking clip, plug-in system: COMBICON MSTB 2,5, locking: without, mounting: without, type of packaging: packed in cardboard

MSTBO 2,5/ 5-GL-5,08 - PCB header

1850466

<https://www.phoenixcontact.com/in/products/1850466>



MVSTBR 2,5/ 5-ST-5,08 - PCB connector

1792278

<https://www.phoenixcontact.com/in/products/1792278>

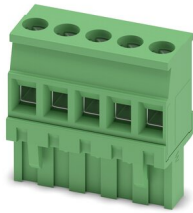

PCB connector, nominal cross section: 2.5 mm², color: green, nominal current: 12 A, rated voltage (III/2): 320 V, contact surface: Tin, type of contact: Socket, number of potentials: 5, number of rows: 1, number of positions: 5, number of connections: 5, product range: MVSTBR 2,5/..-ST, pitch: 5.08 mm, connection method: Screw connection with tension sleeve, screw head form: L Slotted, conductor/PCB connection direction: 90 °, locking clip: - Locking clip, plug-in system: COMBICON MSTB 2,5, locking: without, mounting: without, type of packaging: packed in cardboard

MVSTBW 2,5/ 5-ST-5,08 - PCB connector

1792786

<https://www.phoenixcontact.com/in/products/1792786>

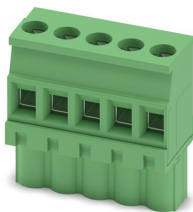

PCB connector, nominal cross section: 2.5 mm², color: green, nominal current: 12 A, rated voltage (III/2): 320 V, contact surface: Tin, type of contact: Socket, number of potentials: 5, number of rows: 1, number of positions: 5, number of connections: 5, product range: MVSTBW 2,5/..-ST, pitch: 5.08 mm, connection method: Screw connection with tension sleeve, screw head form: L Slotted, conductor/PCB connection direction: -90 °, locking clip: - Locking clip, plug-in system: COMBICON MSTB 2,5, locking: without, mounting: without, type of packaging: packed in cardboard

MSTBO 2,5/ 5-GL-5,08 - PCB header

1850466

<https://www.phoenixcontact.com/in/products/1850466>

MSTBC 2,5/ 5-ST-5,08 - PCB connector

1808845

<https://www.phoenixcontact.com/in/products/1808845>



PCB connector, nominal cross section: 2.5 mm², color: green, nominal current: 12 A, rated voltage (III/2): 320 V, type of contact: Socket, number of potentials: 5, number of rows: 1, number of positions: 5, number of connections: 5, product range: MSTBC 2,5/..-ST, pitch: 5.08 mm, connection method: Crimp connection, conductor/PCB connection direction: 0 °, locking clip: - Locking clip, plug-in system: COMBICON MSTB 2,5, locking: without, mounting: without, type of packaging: packed in cardboard, Corresponding female crimp contacts with current [A] and conductor cross section range [mm²] data: 10A/MSTBC-MT 0,5-1,0 (3190564); 10A/MSTBC-MT 0,5-1,0 BA (3190645); 12A/MSTBC-MT 1,5-2,5 (3190551); 12A/MSTBC-MT 1,5-2,5 BA (3190658). BA = Bandkontakte

MSTBC 2,5/ 5-STZ-5,08 - PCB connector

1809530

<https://www.phoenixcontact.com/in/products/1809530>



PCB connector, nominal cross section: 2.5 mm², color: green, nominal current: 12 A, rated voltage (III/2): 320 V, type of contact: Socket, number of potentials: 5, number of rows: 1, number of positions: 5, number of connections: 5, product range: MSTBC 2,5/..-STZ, pitch: 5.08 mm, connection method: Crimp connection, conductor/PCB connection direction: 0 °, locking clip: - Locking clip, plug-in system: COMBICON MSTB 2,5, locking: without, mounting: without, type of packaging: packed in cardboard, Corresponding female crimp contacts with current [A] and conductor cross section range [mm²] data: 10A/MSTBC-MT 0,5-1,0 (3190564); 10A/MSTBC-MT 0,5-1,0 BA (3190645); 12A/MSTBC-MT 1,5-2,5 (3190551); 12A/MSTBC-MT 1,5-2,5 BA (3190658). BA = Bandkontakte

MSTBO 2,5/ 5-GL-5,08 - PCB header

1850466

<https://www.phoenixcontact.com/in/products/1850466>

MSTBU 2,5/ 5-STD-5,08 - Printed-circuit board connector

1824159

<https://www.phoenixcontact.com/in/products/1824159>

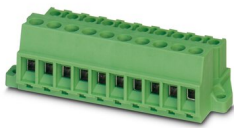

Direct plug-in block, nominal cross section: 2.5 mm², color: green, nominal current: 12 A, rated voltage (III/2): 320 V, contact surface: Tin, type of contact: Socket, number of potentials: 5, number of rows: 1, number of positions: 5, number of connections: 5, product range: MSTBU 2,5/...-STD, pitch: 5.08 mm, connection method: Screw connection with tension sleeve, screw head form: L Slotted, mounting: Direct mounting, conductor/PCB connection direction: 0 °, plug-in system: COMBICON MSTB 2,5, locking: without, mounting: without, type of packaging: packed in cardboard

MSTBVK 2,5/ 5-ST-5,08 - DIN rail connector

1831346

<https://www.phoenixcontact.com/in/products/1831346>



DIN rail connector, nominal cross section: 2.5 mm², color: green, nominal current: 12 A, rated voltage (III/2): 320 V, contact surface: Tin, type of contact: Socket, number of potentials: 5, number of rows: 1, number of positions: 5, number of connections: 5, product range: MSTBVK 2,5/...-ST, pitch: 5.08 mm, connection method: Screw connection with tension sleeve, screw head form: L Slotted, mounting: DIN rail, conductor/PCB connection direction: 0 °, plug-in system: COMBICON MSTB 2,5, locking: without, mounting: without, type of packaging: packed in cardboard

MSTBO 2,5/ 5-GL-5,08 - PCB header

1850466

<https://www.phoenixcontact.com/in/products/1850466>

UMSTBVK 2,5/ 5-ST-5,08 - DIN rail connector

1833849

<https://www.phoenixcontact.com/in/products/1833849>



DIN rail connector, nominal cross section: 2.5 mm², color: green, nominal current: 12 A, rated voltage (III/2): 320 V, contact surface: Tin, type of contact: Socket, number of potentials: 5, number of rows: 1, number of positions: 5, number of connections: 5, product range: UMSTBVK 2,5/..-ST, pitch: 5.08 mm, connection method: Screw connection with tension sleeve, screw head form: L Slotted, mounting: DIN rail, conductor/PCB connection direction: 0 °, plug-in system: COMBICON MSTB 2,5, locking: without, mounting: without, type of packaging: packed in cardboard

TMSTBP 2,5/ 5-ST-5,08 - PCB connector

1853049

<https://www.phoenixcontact.com/in/products/1853049>

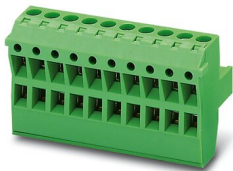

PCB connector, nominal cross section: 2.5 mm², color: green, nominal current: 12 A, rated voltage (III/2): 320 V, contact surface: Tin, type of contact: Socket, number of potentials: 5, number of rows: 1, number of positions: 5, number of connections: 10, product range: TMSTBP 2,5/..-ST, pitch: 5.08 mm, connection method: Screw connection with tension sleeve, screw head form: L Slotted, conductor/PCB connection direction: 0 °, locking clip: - Locking clip, plug-in system: COMBICON MSTB 2,5, locking: without, mounting: without, type of packaging: packed in cardboard, The plug allows conductors to be looped through from module to module.

MSTBO 2,5/ 5-GL-5,08 - PCB header

1850466

<https://www.phoenixcontact.com/in/products/1850466>



FKC 2,5/ 5-ST-5,08 - PCB connector

1873087

<https://www.phoenixcontact.com/in/products/1873087>

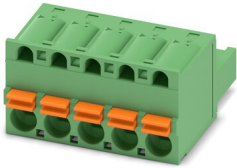

PCB connector, nominal cross section: 2.5 mm², color: green, nominal current: 12 A, rated voltage (III/2): 320 V, contact surface: Tin, type of contact: Socket, number of potentials: 5, number of rows: 1, number of positions: 5, number of connections: 5, product range: FKC 2,5/..-ST, pitch: 5.08 mm, connection method: Push-in spring connection, conductor/PCB connection direction: 0 °, locking clip: - Locking clip, plug-in system: COMBICON MSTB 2,5, locking: without, mounting: without, type of packaging: packed in cardboard

FKCVW 2,5/ 5-ST-5,08 - PCB connector

1873689

<https://www.phoenixcontact.com/in/products/1873689>



PCB connector, nominal cross section: 2.5 mm², color: green, nominal current: 12 A, rated voltage (III/2): 320 V, contact surface: Tin, type of contact: Socket, number of potentials: 5, number of rows: 1, number of positions: 5, number of connections: 5, product range: FKCVW 2,5/..-ST, pitch: 5.08 mm, connection method: Push-in spring connection, conductor/PCB connection direction: -90 °, locking clip: - Locking clip, plug-in system: COMBICON MSTB 2,5, locking: without, mounting: without, type of packaging: packed in cardboard

MSTBO 2,5/ 5-GL-5,08 - PCB header

1850466

<https://www.phoenixcontact.com/in/products/1850466>



FKCVR 2,5/ 5-ST-5,08 - PCB connector

1873980

<https://www.phoenixcontact.com/in/products/1873980>

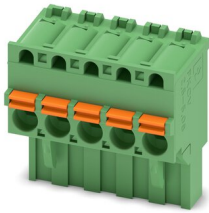

PCB connector, nominal cross section: 2.5 mm², color: green, nominal current: 12 A, rated voltage (III/2): 320 V, contact surface: Tin, type of contact: Socket, number of potentials: 5, number of rows: 1, number of positions: 5, number of connections: 5, product range: FKCVR 2,5/...-ST, pitch: 5.08 mm, connection method: Push-in spring connection, conductor/PCB connection direction: 90 °, locking clip: - Locking clip, plug-in system: COMBICON MSTB 2,5, locking: without, mounting: without, type of packaging: packed in cardboard

QC 1/ 5-ST-5,08 - PCB connector

1883284

<https://www.phoenixcontact.com/in/products/1883284>

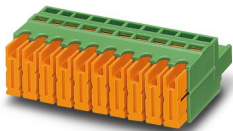

PCB connector, nominal cross section: 1 mm², color: green, nominal current: 10 A, rated voltage (III/2): 630 V, contact surface: Tin, type of contact: Socket, number of potentials: 5, number of rows: 1, number of positions: 5, number of connections: 5, product range: QC 1/...-ST, pitch: 5.08 mm, connection method: Displacement connection, conductor/PCB connection direction: 0 °, locking clip: - Locking clip, plug-in system: COMBICON MSTB 2,5, locking: without, mounting: without, type of packaging: packed in cardboard

MSTBO 2,5/ 5-GL-5,08 - PCB header

1850466

<https://www.phoenixcontact.com/in/products/1850466>



FKCT 2,5/ 5-ST-5,08 - PCB connector

1902149

<https://www.phoenixcontact.com/in/products/1902149>

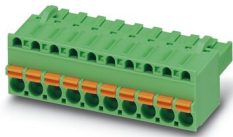

PCB connector, nominal cross section: 2.5 mm², color: green, nominal current: 12 A, rated voltage (III/2): 320 V, contact surface: Tin, type of contact: Socket, number of potentials: 5, number of rows: 1, number of positions: 5, number of connections: 5, product range: FKCT 2,5/..-ST, pitch: 5.08 mm, connection method: Push-in spring connection, conductor/PCB connection direction: 0 °, locking clip: - Locking clip, plug-in system: COMBICON MSTB 2,5, locking: without, mounting: without, type of packaging: packed in cardboard

TFKC 2,5/ 5-ST-5,08 - PCB connector

1962639

<https://www.phoenixcontact.com/in/products/1962639>

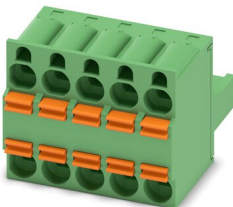

PCB connector, nominal cross section: 2.5 mm², color: green, nominal current: 12 A, rated voltage (III/2): 320 V, contact surface: Tin, type of contact: Socket, number of potentials: 5, number of rows: 1, number of positions: 5, number of connections: 10, product range: TFKC 2,5/..-ST, pitch: 5.08 mm, connection method: Push-in spring connection, conductor/PCB connection direction: 0 °, locking clip: - Locking clip, plug-in system: COMBICON MSTB 2,5, locking: without, mounting: without, type of packaging: packed in cardboard

MSTBO 2,5/ 5-GL-5,08 - PCB header

1850466

<https://www.phoenixcontact.com/in/products/1850466>



FKCS 2,5/ 5-ST-5,08 - PCB connector

1975105

<https://www.phoenixcontact.com/in/products/1975105>



PCB connector, nominal cross section: 2.5 mm², color: green, nominal current: 12 A, rated voltage (III/2): 320 V, contact surface: Tin, type of contact: Socket, number of potentials: 5, number of rows: 1, number of positions: 5, number of connections: 5, product range: FKCS 2,5/..-ST, pitch: 5.08 mm, connection method: Push-in spring connection, conductor/PCB connection direction: 0 °, locking clip: - Locking clip, plug-in system: COMBICON MSTB 2,5, locking: without, mounting: without, type of packaging: packed in cardboard

Phoenix Contact 2023 © - all rights reserved

<https://www.phoenixcontact.com>

PHOENIX CONTACT (I) Pvt. Ltd.

A-58/2, Okhla Industrial Area, Phase - II, New Delhi-110 020

+91.1275.71420

info@phoenixcontact.co.in