

Amphenol

MS AND 97B - SERIES

ACR 11 0601



Amphenol

Introduction

Amphenol MS and 97B series are two series of thread & Bayonet-coupled connectors designed to meet the operating requirements of **MIL-C-5015**. Available in a variety of styles and classes, these connectors are primarily used in a range of military and industrial applications where specific degrees of environmental protection are required.

Although MS series have identical insert arrangements and other similar component parts, the two series differ in that Amphenol MS series of connectors are also qualified to meet the operating requirements of Defence Standard Joint Services Specification **JSS50812**, issued by the Electronics Components Standardization Organisation (LCSO).

Amphenol 97B connectors feature a quick mating bayonet coupling with an audible full mating feature. This series uses the same **MIL-C-5015** insert patterns and are used in high shock and vibration environments encountered in commercial, geophysical, aerospace, ground support and shipboard applications.

Page Contents

1	Introduction
2-3	Connector styles
4	General description
5	Electrical data
6	Insert orientations
7-18	Insert arrangements
19-25	Shell types
26-28	Back accessories
29-33	Other accessories
34	MS/97B Series
35	Ordering MS/97B series connectors

Connector Styles - MS

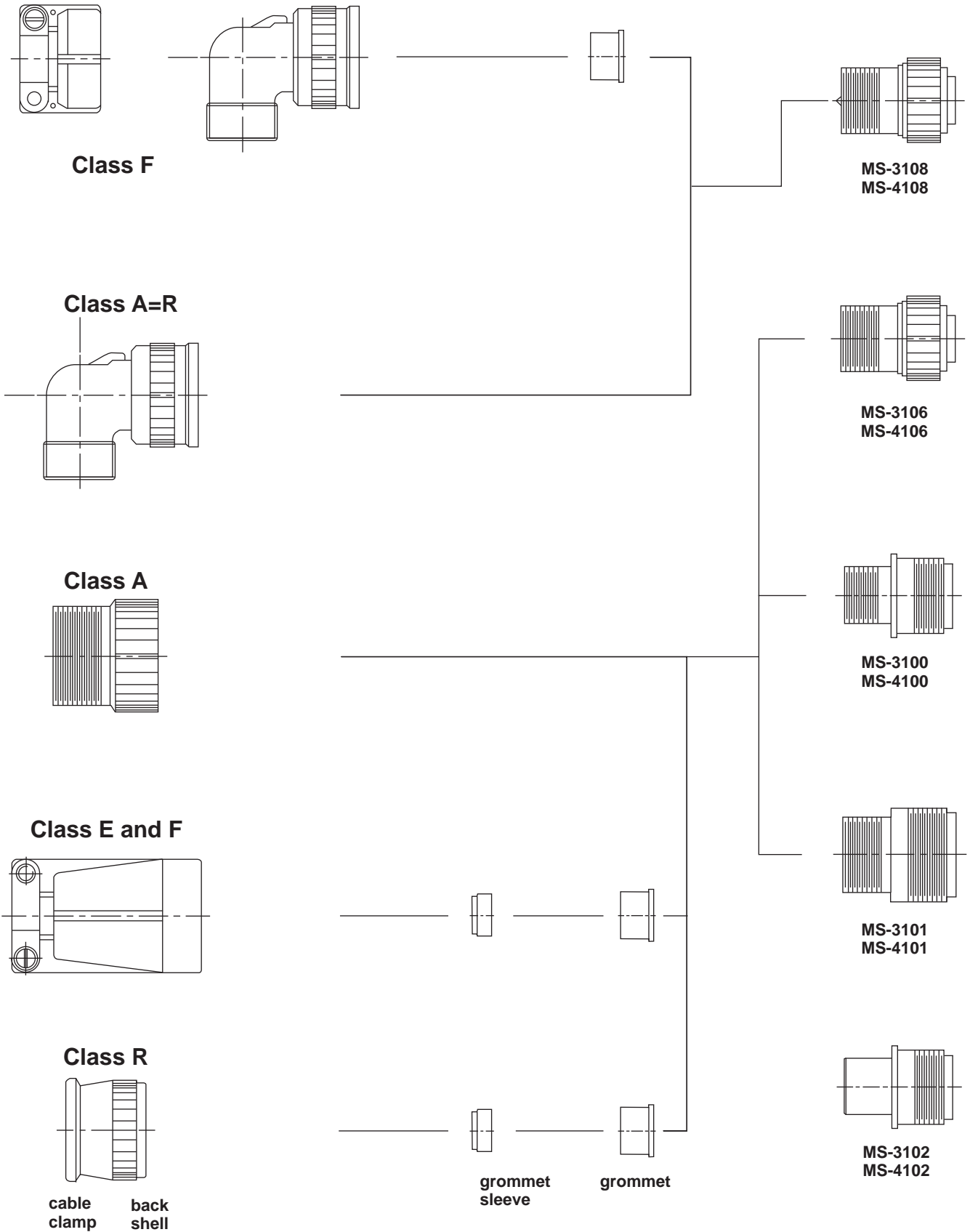

Connector Styles - 97B

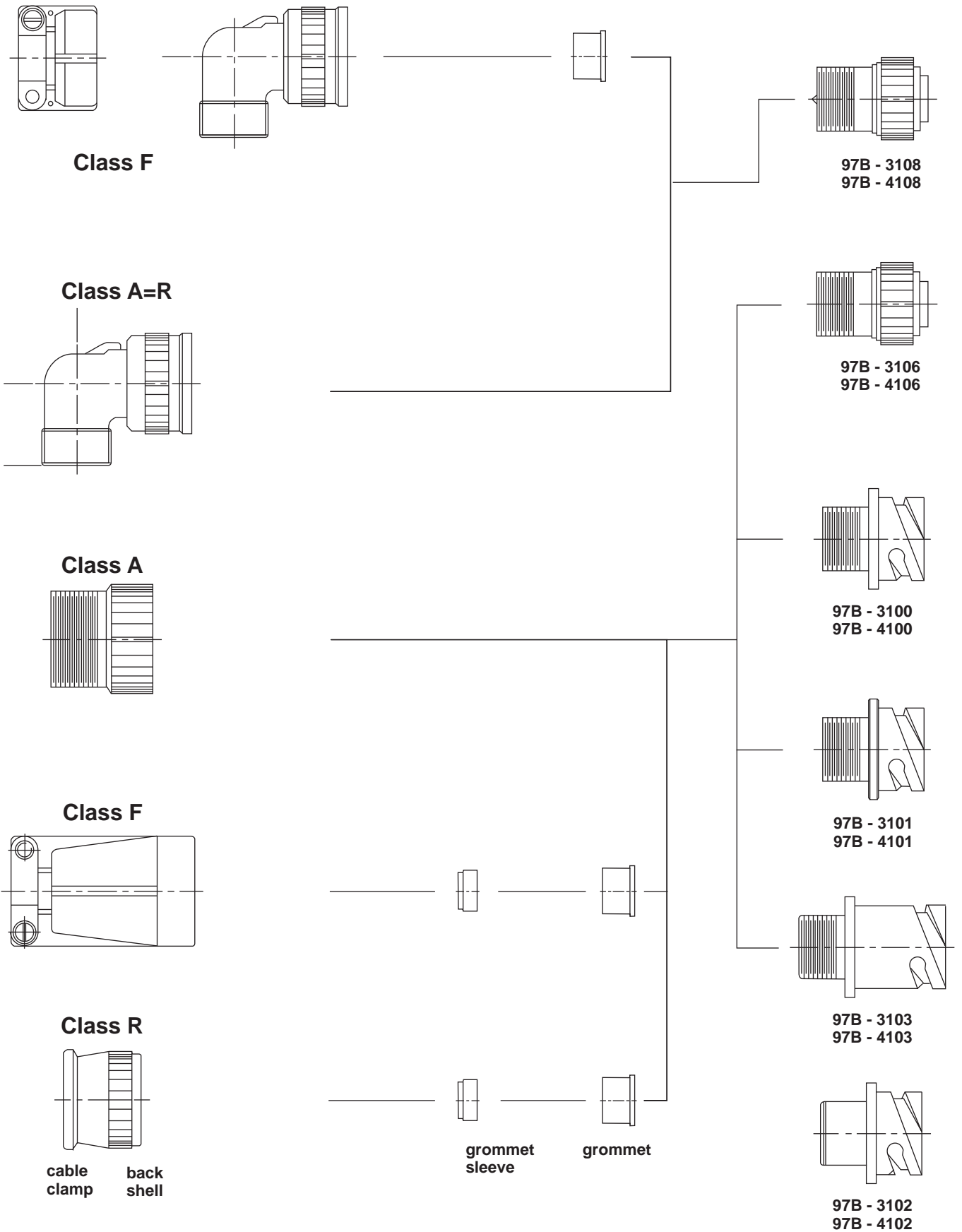

General Description

These electrical connectors are designated MS because the interchangeability and operating characteristics are determined by U.S. Military Specifications. These specifications are revised from time to time to incorporate performance requirements dictated by design advances and more stringent requirements of allied equipment. The several designations of MS and 97B connectors meet different requirements of MIL-C-5015. These designations and general descriptions are as follows :

Shell

Shell constructions include solid back shell (A) and environmental resistant (E, F & R). Environmental resistant connectors provide a moisture barrier and assure a positive seal. Shell styles consist of wall type receptacles (3100), cable receptacles (3101), box receptacles (3102), straight plugs (3106) and angle plugs (3108). Shell hardware is manufactured from aluminium alloy and cadmium plated with olive drab chromate finish. This finish has excellent conductivity; it is non-reflecting and corrosion resistant. Black anodised finish and cadmium-free zinc plating with olive drab chromate finish are also available. For details, contact factory.

Contacts

Pin and socket contacts are of brass and generally silver plated. Gold plating is also available. For details contact factory. These contacts are available for solder or crimp termination. Special arrangements of contacts for pre-mating and pre-earth are also available.

Inserts and grommet

Synthetic inserts and grommet manufactured according to MIL-R-3065, offer high dielectric strength and are resistant to oils, gasoline and low temperature. DAP is dimensionally stable, has high arc resistance and high insulation resistance under both humidity and thermal stress.

General description

Plugs are available in A, F and R types. Receptacles are available in A, E, F and R types.

A Solid back shell

Intended for general service usage to provide convenient means of connecting and disconnecting electrical circuits in industrial and military applications.

Environmental resisting

Intended for use where the connector will be subject to heavy condensation and rapid changes in temperature or pressure and/or where the connector is subjected to high vibratory conditions.

E Environmental resisting with grommet seal and strain relief backshell except for 3102 type.

F Environmental resisting with grommet seal, strain relief backshell and front gasket seal for plug type.

R Environmental resisting with grommet seal, shorter and lightweight.

Features for 97B reverse bayonet coupling connectors with Mil-C-5015 insert patterns:

- Quick positive coupling
- Audible and tactile indication of full coupling
- Waterproof
- No lockwiring required
- High shock and vibration capabilities
- Insert available in Neoprene material (alternate inserts materials available upon request)
- Operating temperature range with Neoprene inserts: -55°C to +125°C
- Available in both crimp and solder terminations
- Contacts available in gold and silver plating
- Numerous finishes available
- Zinc alloy plating (cadmium free) available
- Rugged construction; aluminum or stainless steel components
- Intermateable with existing VG95234 connectors
- 500 couplings minimum

Electrical Data

Dielectric strength

Service rating	Test Voltage Vac rms
Inst.	1000V
A	2000V
D	2800V
E	3500V
B	4500V
C	7000V

Contact rating

Contact Size	Rated Current	Contact Resistance miliohms
16	13A	3.46
12	23A	1.83
8	46A	0.52
4	80A	0.26
0	150A	0.14

Service rating

Service rating	Operating Voltage DC at Sea Level	Operating Voltage AC at Sea Level
Inst.	250V	200V
A	700V	500V
D	1250V	900V
E	1750V	1250V
B	2450V	1750V
C	4200V	3000V

Insert Arrangements

Insert Arrangement	Service Rating	Total Contacts	Contact Size				
			0	4	8	12	16
10S-2	A	1					1
10SL-3	A	3					3
10SL-4	A	2					2
12S-3	A	2					2
12S-4	D	1					1
12-5	D	1					1
14S-1	A	3					3
14S-2	Inst	4					4
14S-4	D	1					1
14S-5	Inst	5					5
14S-6	Inst	6					6
14S-7	A	3					3
14S-9	A	2					2
14S-10	Inst	4					4
14S-12	A	3					3
14-3	A	1			1		
14S-A7	A	7					7
16S-1	A	7					7
16S-3	B	1					1
16S-4	D	2					2
16S-5	A	3					3
16S-6	A	3					3
16S-8	A	5					5
16-2	E	1				1	
16-7	A	3			1	2	
16-9	A	4				2	2
16-10	A	3				3	
16-11	A	2				2	
16-12	A	1		1			
16-13	A	2				2	
18-1	A/Inst	10					10
18-3	D	2				2	
18-4	D	4					4
18-5	D	3				2	1
18-06		6				4	2
18-6	D	1		1			
18-7	B	1			1		
18-8	A	8				1	7
18-9	Inst	7				2	5
18-10	A	4				4	
18-11	A	5				5	
18-12	A	6					6
18-13	A	4			1	3	
18-14	A	2		1			1
18-15	A	4				4	
18-16	C	1				1	
18-17	Inst	7				2	5
18-19	A	10					10
18-20	A	5					5
18-22	D	3					3
18-24	A/Inst	10					10
18-29	A	5					5
18-30	A	5					5
18-31	A	5					5
20-2		1	1				
20-3	D	3				3	
20-4	D	4				4	
20-6	D	3					3
20-7	D/A	8					8

Insert Arrangement	Service Rating	Total Contacts	Contact Size				
			0	4	8	12	16
20-8	Inst	6			2		4
20-9	D/A	8				1	7
20-11	Inst	13					13
20-12	A	2		1			1
20-14	A	5			2	3	
20-15	A	7				7	
20-16	A	9				2	7
20-17	A	6				5	1
20-18	A	9				3	6
20-19	A	3			3		
20-20	A	4		1		3	
20-21	A	9				1	8
20-22	A	6			3		3
20-23	A	2			2		
20-24	A	4			2		2
20-25	Inst	13					13
20-27	A	14					14
20-29	A	17					17
20-30	Inst	13					13
20-33	A	11					11
20-A48	A	19					
20-A9	A	9					
22-1	D	2			2		
22-2	D	3			3		
22-4	A	4			2	2	
22-5	D	6				2	4
22-6	D	3			2		1
22-7	E	1	1				
22-8	E	2				2	
22-9	E	3				3	
22-10	E	4					4
22-11	B	2					2
22-12	D	5			2		3
22-13	D/A	5				4	1
22-14	A	19					19
22-15	E/A	6				5	1
22-16	A	9				3	6
22-17	D/A	9				1	8
22-18	D/A	8					8
22-19	A	14					14
22-20	A	9					9
22-21	A	3	1				2
22-22	A	4			4		
22-23	D/A	8				8	
22-24	D/A	6				2	4
22-27	D/A	9			1		8
22-28	A	7				7	
22-33	D/A	7					7
22-34	D	5				3	2
24-2	D	7				7	
24-3	D	7				2	5
24-4		1					3
24-5	A	16					16
24-6	D/A	8				8	
24-06	A	6		4			2
24-7	A	16				2	14
24-9	A	2		2			
24-10	A	7			7		

Insert Arrangement	Service Rating	Total Contacts	Contact Size						
			0	4	8	12	16		
24-11	A	9				3	6		
24-12	A	5			2		3		
24-16	D/A	7			1	3	3		
24-17	D	5				2	3		
24-20	D	11					2	9	
24-21	D	10				1		9	
24-22	D	4			4				
24-27	E	7						7	
24-28	Inst	24						24	
28-1	D/A	9			3	6			
28-2	D	14					2	12	
28-3	E	3				3			
28-4	E/D	9					2	7	
28-5	D	5		2			1	2	
28-6	D	3		3					
28-7	D	2		2					
28-8	E/D/A	12					2	10	
28-9	D	12					6	6	
28-09	A	9		4				5	
28A-9	D	9			3	2	4		
28-10	D/A	7		2	2	3			
28-11	A	22				4	18		
28-12	A	26						26	
28-13	A	26						26	
28-15	A	35						35	
28-16	A	20						20	
28-17	B/D/A	15						15	
28-18	C/D/A/Inst	12						12	
28-19	B/D/A	10					4	6	
28-20	A	14					10	4	
28-21	A	37						37	
28-22	D	6		3				3	
28-51	D	12						12	
32-1	D/A	5	2				3		
32-3	D	9	1	2			2	4	
32-4	A/D	14						2	12
32-5	D	2	2						
32-6	A	23		2	3	2	16		
32-7	INST,A	35					7	28	
32-8	A	30					6	24	
32B-13	D	13				13			
32-17	D	4		4					
32-22	A	54							54
36-1	D	22					4	18	
36-3	D	6	3				3		
36-4	D/A	3	3						
36-5	A	4	4						
36-6	A	6	2	4					
36-7	A	47					7	40	
36-8	A	47					1	46	
36-9	A	31		1	2	14	14		
36-10	A	48						48	
36-11	A	48						48	
36-12	A	48						48	
36-13	E/A	17				2	15		
36-14	D	16			5	5	6		
36-15	D/A	35						35	
36-16	A	47				7	40		
36-17	A	47				7	40		
38-18	A	31		1	2	14	14		
36-20	A	34			2	2	30		
36-46	A	27						27	
36-52	A	52						52	
40-56	A	85						85	
40-63	A	61							

Insert Arrangements

Front face of pin insert or rear of socket insert illustrated

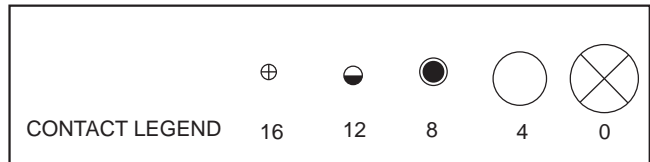

		Front of socket insert	Front of socket insert			
Insert arrangement	10S-2	10SL-3	10SL-4	12S-3	12S-4	12-5
Service rating	A	A	A	A	A	D
Number of contacts	1	3	2	2	1	1
Contact size	16	16	16	16	16	12
Premating contact	-	C	-	-	-	-
Insert arrangement	14S-A7	14S-1	14S-2	14S-4	14S-5	14S-6
Service rating	A	A	Inst.	D	Inst.	Inst.
Number of contacts	7	3	4	1	5	6
Contact size	16	16	16	16	16	16
Premating contact	-	-	-	-	-	-
			100° rotation of 14S-2	100° rotation of 14S-7		
Insert arrangement	14S-7	14S-9	*14S-10	*14S-12	*14-3	16S-1
Service rating	A	A	Inst.	A	A	A
Number of contacts	3	2	4	3	1	7
Contact size	16	16	16	16	8	16
Premating contact	B	-	-	B	-	G
Insert arrangement	*16S-3	16S-4	16S-5	16S-6	16S-8	*16-2
Service rating	B	D	A	A	A	E
Number of contacts	1	2	3	3	5	1
Contact size	16	16	16	16	16	12
Premating contact	-	-	A	B	E	-

*Not tooled up, can be tooled up on request. Contact Factory.

Insert Arrangements

Front face of pin insert or rear of socket insert illustrated

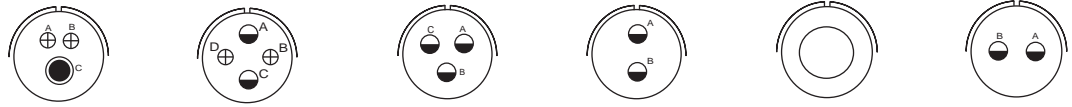
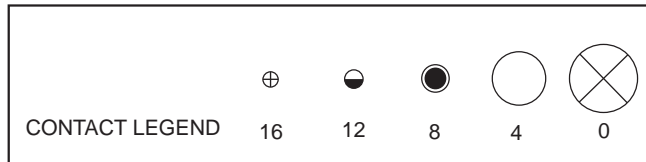

Insert arrangement	16-7	16-9	16-10	16-11	16-12	*16-13
Service rating	A	A	A	A	A	A
Number of contacts	1 2	2 2	3	2	1	2
Contact size	8 16	12 16	12	12	4	12
Premating contact	C	-	B	-	-	-

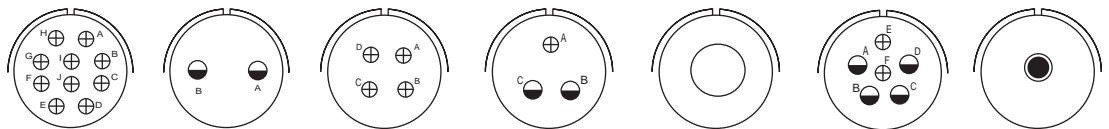

Insert arrangement	18-1	18-3	18-4	18-5	*18-6	18-06	18-7
Service rating	B,C,F,G=A; Bal.=Inst.	D	D	D	D	A	B
Number of contacts	10	2	4	2 1	1	2 4	1
Contact size	16	12	16	12 16	4	16 12	8
Premating contact	-	-	A	C	-	-	-



Insert arrangement	18-8	18-9	18-10	18-11	18-12	*18-13
Service rating	A	Inst.	A	A	A	A
Number of contacts	1 7	2 5	4	5	6	1 3
Contact size	12 16	12 16	12	12	16	8 12
Premating contact	H	-	D	E	C or D	A

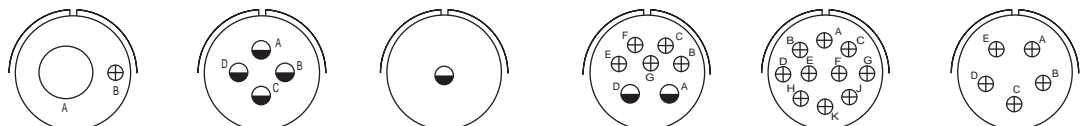

Insert arrangement	*18-14	18-15	18-16	*18-17	18-19	18-20
Service rating	A	A	C	Inst.	A	A
Number of contacts	1 1	4	1	2 5	10	5
Contact size	4 16	12	12	12 16	16	16
Premating contact	-	-	-	-	K	D

100° rotation of 18-9

*Not tooled up, can be tooled up on request. Contact Factory.

Insert Arrangements

Front face of pin insert or rear of socket insert illustrated

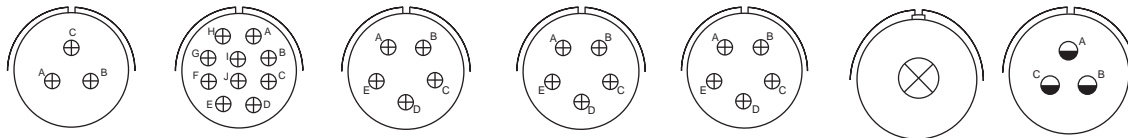
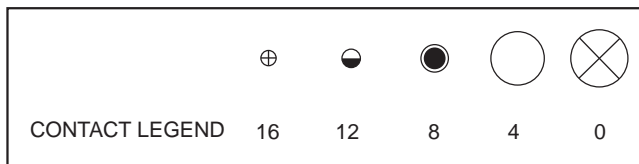

		250° rotation of 18-1		110° rotation of 18-20	260° rotation of 18-20		
Insert arrangement	18-22	*18-24	*18-29	*18-30	*18-31	20-2	20-3
Service rating	D	B,C,F,G=A; Bal.=Inst.	A	A	A	D	D
Number of contacts	3	10	5	5	5	1	4
Contact size	16	16	16	16	16	0	12
Premating contact	C	-	D	C	C	-	A

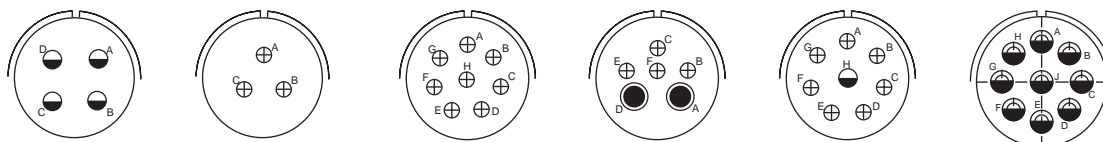

Insert arrangement	20-4	*20-6	20-7	20-8	20-9	20A-9
Service rating	D	D	A,B,H,G=D; C,D,E,F=A	Inst.	H=D; Bal.=A	A
Number of contacts	4	3	8	2 4	1 7	9
Contact size	12	16	16	8 16	12 16	12
Premating contact	C or D	A	A	-	H	-



Insert arrangement	20-11	*20-12	20-14	20-15	20-16	20-17
Service rating	Inst.	A	A	A	A	A
Number of contacts	13	1 1	2 3	7	2 7	5 1
Contact size	16	4 16	8 12	12	12 16	12 16
Premating contact	-	-	D	A or D	E	E or F

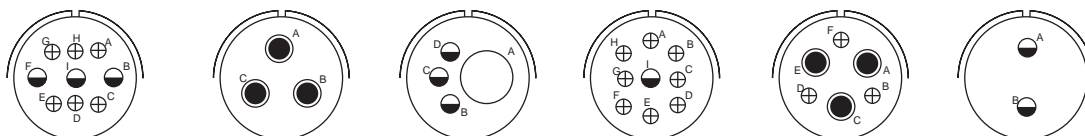

Insert arrangement	20-18	20-19	20-20	*20-21	20-22	20-23
Service rating	A	A	A	A	A	A
Number of contacts	3 6	3	1 3	1 8	3 3	2
Contact size	12 16	8	4 12	12 16	8 16	8
Premating contact	D	C	A	1	-	-

*Not tooled up, can be tooled up on request. Contact Factory.

Insert Arrangements

Front face of pin insert or rear of socket insert illustrated

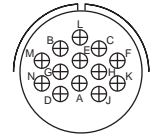
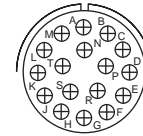
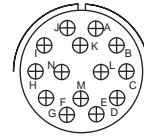
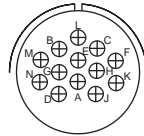
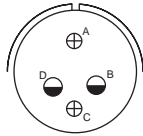
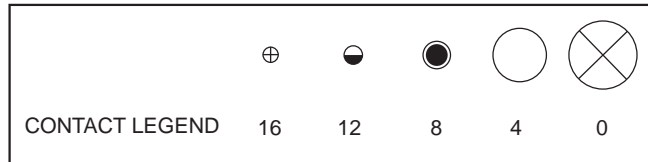

Insert arrangement
Service rating
Number of contacts
Contact size
Premating contact

20-24
A
2 2
8 16
-

100° rotation
of 20-11

*20-25
Inst.
13
16
-

20-27
A
14
16
M

20-29
A
17
16
G

250° rotation
of 20-11

*20-30
Inst.
13
16
-

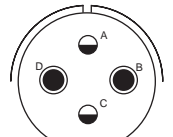
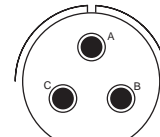
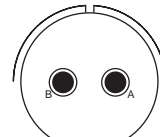
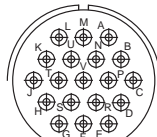
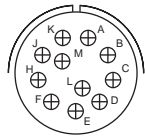

Insert arrangement
Service rating
Number of contacts
Contact size
Premating contact

20-33
A
11
16
E

20 A - 48
A
19
16
-

22-1
D
2
8
-

22-2
D
3
8
A

*22-4
A
2 2
8 12
C

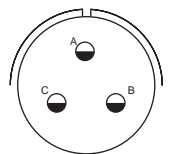
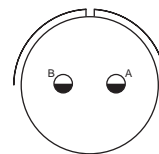
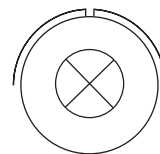
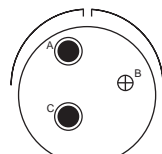
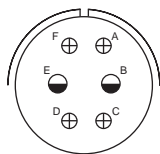

Insert arrangement
Service rating
Number of contacts
Contact size
Premating contact

22-5
D
2 4
12 16
D

*22-6
D
2 1
8 16
B

22-7
E
1
0
-

*22-8
E
2
12
-

22-9
E
3
12
A

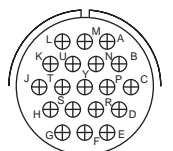
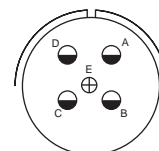
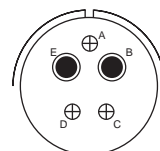
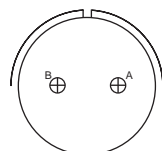
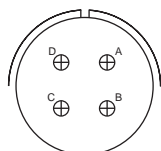

Insert arrangement
Service rating
Number of contacts
Contact size
Premating contact

22-10
E
4
16
C

22-11
B
2
16
-

22-12
D
2 3
8 16
A

22-13
E=D; A, B, C, D=A
4 1
12 16
E

22-14
A
19
16
A

*Not tooled up, can be tooled up on request. Contact Factory.

Insert Arrangements

Front face of pin insert or rear of socket insert illustrated

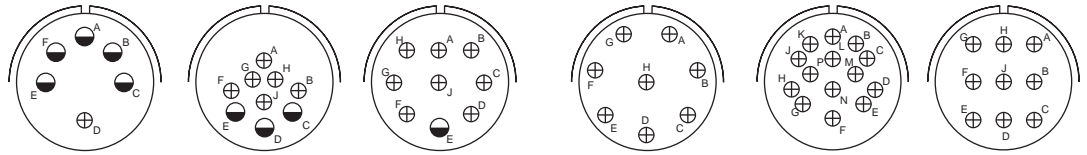
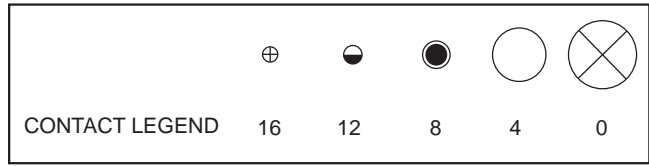

Insert arrangement	22-15	22-16	*22-17	22-18	22-19	22-20
Service rating	D=E;A,B,C,E,F=A	A	A=D;Bal.=A	A,B,F,G,H=D;C,D,E=A	A	A
Number of contacts	5 1	3 6	1 8	8	14	9
Contact size	12 16	12 16	12 16	16	16	16
Premating contact	D	D	E	D	F	D

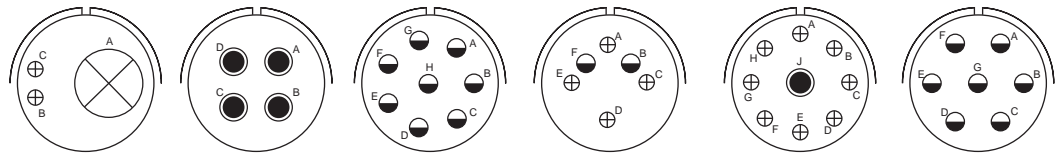

Insert arrangement	*22-21	22-22	22-23	22-24	22-27	22-28
Service rating	A	A	H=D;Bal.=A	C,D,E=D;A,B,F=A	J=D;Bal.=A	A
Number of contacts	1 2	4	8	2 4	1 8	7
Contact size	0 16	8	12	12 16	8 16	12
Premating contact	-	C or D	A or D	D	-	G

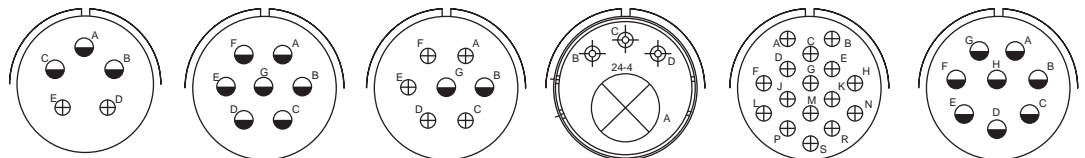

Insert arrangement	*22-34	24-2	*24-3	24-4	24-5	24-6
Service rating	D	D	D	A	A	A,G,H=D;Bal.=A
Number of contacts	3 2	7	2 5	3 1	16	8
Contact size	12 16	12	12 16	16 0	16	12
Premating contact	E	A	D	-	S	D

*Not tooled up, can be tooled up on request. Contact Factory.

Insert Arrangements

Front face of pin insert or rear of socket insert illustrated

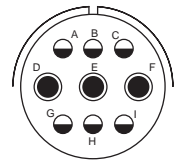
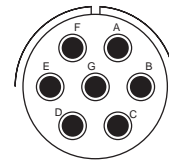
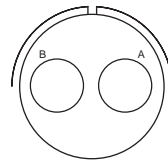
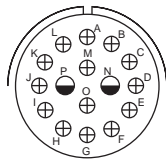
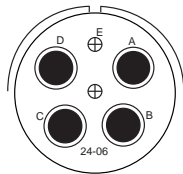
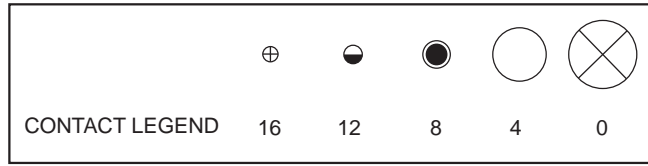

Insert arrangement
Service rating
Number of contacts
Contact size
Premating contact

24-06
A
2 4
16 8
-

24-7
A
2 14
12 16
G

24-9
A
2
4
-

24-10
A
7
8
D or E or G

24-11
A
3 6
8 12
E

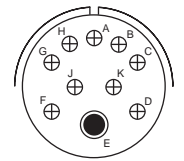
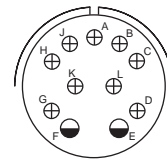
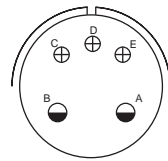
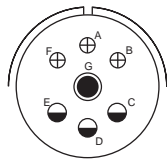
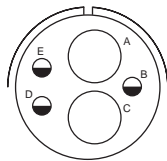

Insert arrangement
Service rating
Number of contacts
Contact size
Premating contact

24-12
A
2 3
4 12
-

*24-16
A,B,F,G=D; C,D,E=A
1 3 3
8 12 16
G

*24-17
D
2 3
12 16
D

24-20
D
2 9
12 16
A

24-21
D
1 9
8 16
E

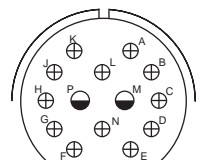
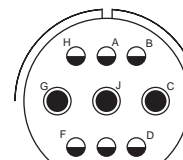
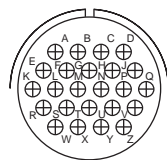
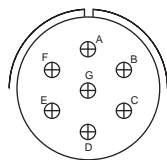
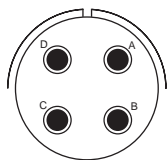

Insert arrangement
Service rating
Number of contacts
Contact size
Premating contact

24-22
D
4
8
D

*24-27
E
7
16
D

24-28
Inst.
24
16
-

28-1
A,J,E=D; Bal.=A
3 6
8 12
E

*28-2
D
2 12
12 16
E

*Not tooled up, can be tooled up on request. Contact Factory.

Insert Arrangements

Front face of pin insert or rear of socket insert illustrated

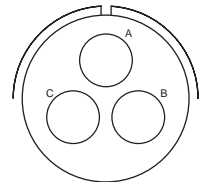
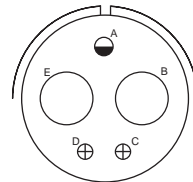
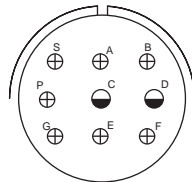
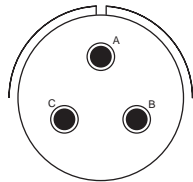
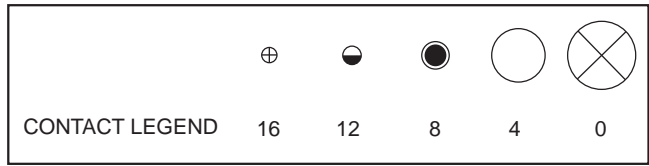

Insert arrangement
Service rating
Number of contacts
Contact size
Premating contact

28-3
E
3
8
A

*28-4
G,S,P=E;Bal.=D
2 7
12 16
E

*28-5
D
2 1 2
4 12 16
-

28-6
D
3
4
A

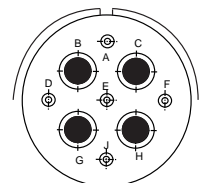
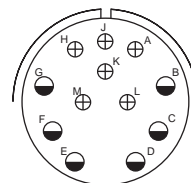
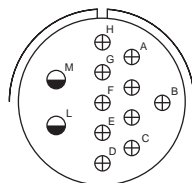
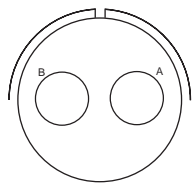

Insert arrangement
Service rating
Number of contacts
Contact size
Premating contact

28-7
D
2
4
-

28-8
L,M=E;B=D;Bal.=A
2 10
12 16
D

28-9
D
6 6
12 16
E

28-09
A
5 4
16 8
-

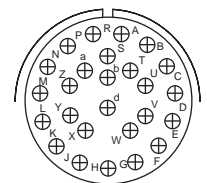
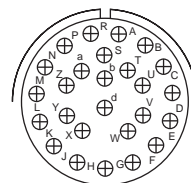
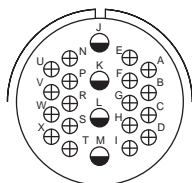
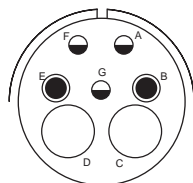

Insert arrangement
Service rating
Number of contacts
Contact size
Premating contact

28-10
G=D;Bal.=A
2 2 3
4 8 12
G

28-11
A
4 18
12 16
M

28-12
A
26
16
H

100° rotation
of 28-12
*28-13
A
26
16
H

*Not tooled up, can be tooled up on request. Contact Factory.

Insert Arrangements

Front face of pin insert or rear of socket insert illustrated

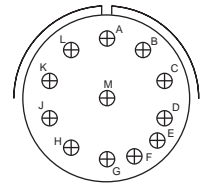
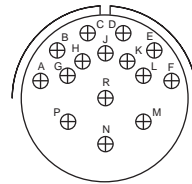
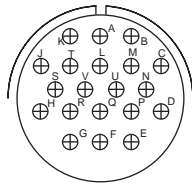
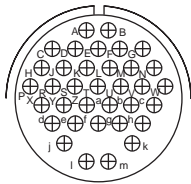
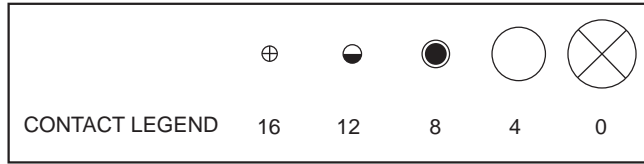

Insert arrangement	28-15	28-16	*28-17	28-18
Service rating	A	A	R=B;M,N,P=D;A to L=A	M=C;G,H,J,K,L=D;A,B=ABal.=Inst.
Number of contacts	35	20	15	12
Contact size	16	16	16	16
Premating contact	M	F	N	-

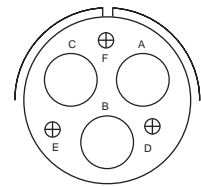
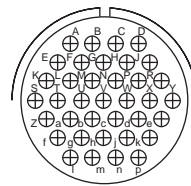
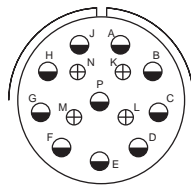
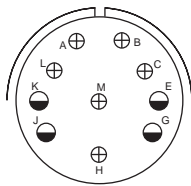

Insert arrangement	28-19	28-20	28-21	28-22
Service rating	H,M=B;A,B=D;Bal.=A	A	A	D
Number of contacts	4 6	10 4	37	3 3
Contact size	12 16	12 16	16	4 16
Premating contact	H	E	A	-

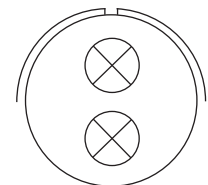
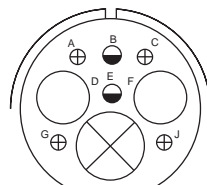
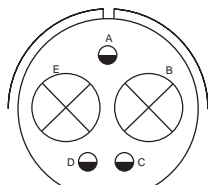
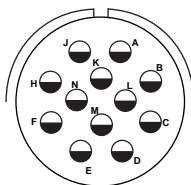

Insert arrangement	28-51	32-1	*32-3	32-5
Service rating	D	A=E;B,C,D,E=A	D	D
Number of contacts	12	2 3	1 2 2 4	2
Contact size	12	0 12	0 4 12 16	0
Premating contact	-	-	-	-

*Not tooled up, can be tooled up on request. Contact Factory.

Insert Arrangements

Front face of pin insert or rear of socket insert illustrated

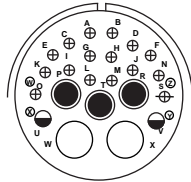
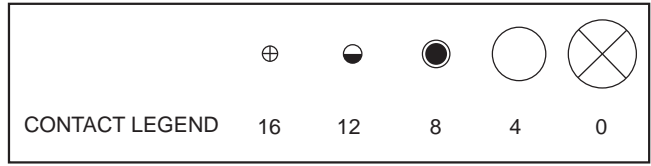

Insert arrangement
Service rating
Number of contacts
Contact size
Premating contact

32-6
A
16 2 3 2
16 12 8 4
-

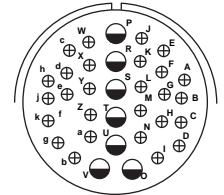

32-7
INST, A
4 24 7
16 12
-

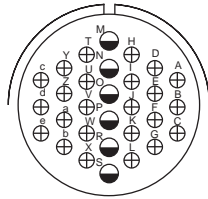

Insert arrangement
Service rating
Number of contacts
Contact size
Premating contact

32-8
A
6 24
12 16
S

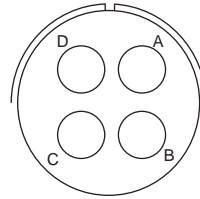

32-17
D
4
4
-

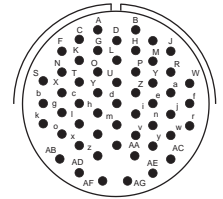

32-22
A
54
16
-

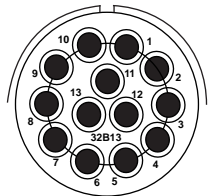

Insert arrangement
Service rating
Number of contacts
Contact size
Premating contact

32B-13
D
13
8
-

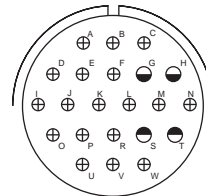

*36-1
D
4 18
12 16
-

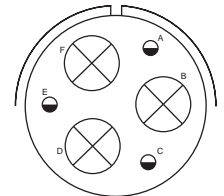

36-3
D
3 3
0 12
-

*Not tooled up, can be tooled up on request. Contact Factory.

Insert Arrangements

Front face of pin insert or rear of socket insert illustrated

CONTACT LEGEND	16	12	8	4	0

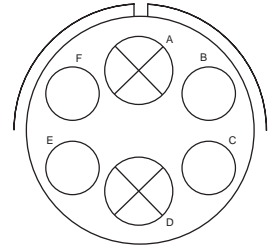
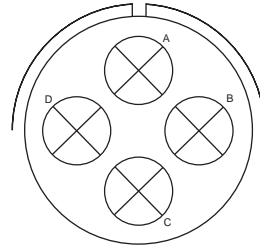
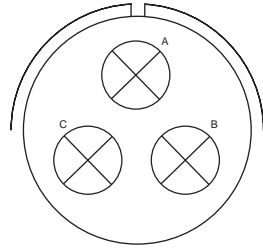

Insert arrangement
Service rating
Number of contacts
Contact size
Premating contact

36-4
A=D; B, C=A
3
0
-

36-5
A
4
0
-

36-6
A
2 4
0 4
-

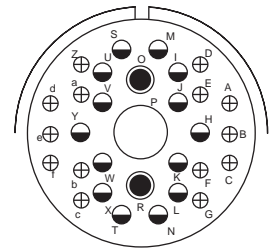
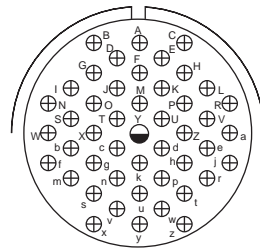
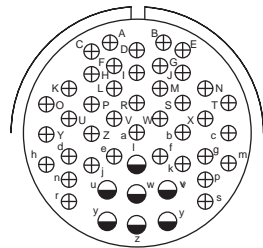

Insert arrangement
Service rating
Number of contacts
Contact size
Premating contact

***36-7**
A
7 40
12 16
x or y

***36-8**
A
1 46
12 16
Y

***36-9**
A
1 2 14 14
4 8 12 16
P

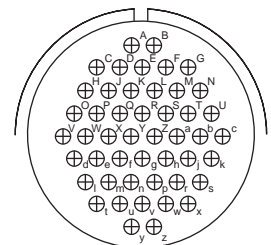
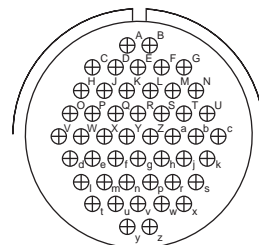
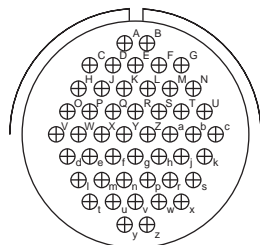

Insert arrangement
Service rating
Number of contacts
Contact size
Premating contact

36-10
A
48
16
A

100° rotation
of 36-10
***36-11**
A
48
16
A

250° rotation
of 36-10
***36-12**
A
48
16
A

*Not tooled up, can be tooled up on request. Contact Factory.

Insert Arrangements

Front face of pin insert or rear of socket insert illustrated

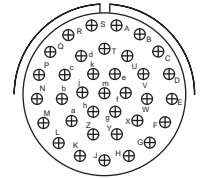
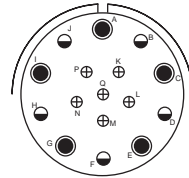
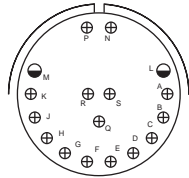
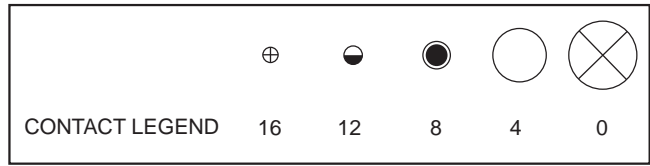

Insert arrangement
Service rating
Number of contacts
Contact size
Premating contact

***36-13**
N,P,Q=E;Bal.=A
2 15
12 16
-

***36-14**
D
5 5 6
8 12 16
-

***36-15**
M=D;Bal=A
35
16
J

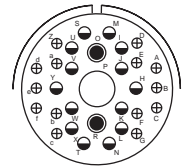
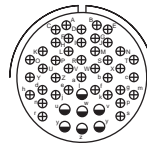
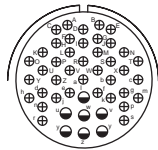

Insert arrangement
Service rating
Number of contacts
Contact size
Premating contact

100° rotation
of 36-7

250° rotation
of 36-7

100° rotation
of 36-9

***36-16**
A
7 40
12 16
x or y

***36-17**
A
7 40
12 16
x or y

***36-18**
A
1 2 14 16
4 8 12 16
-

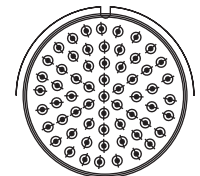
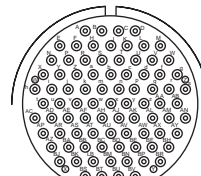
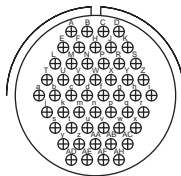
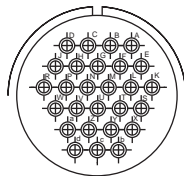
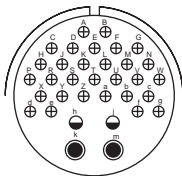

Insert arrangement
Service rating
Number of contacts
Contact size
Premating contact

***36-20**
A
2 2 30
8 12 16
k

36-46
A
27
16
-

36-52
A
52
16
-

40-56
A
85
16
-

40-63
A
61
16
-

*Not tooled up, can be tooled up on request. Contact Factory.

Shell Types
Wall mounting receptacle
MS-3100 MS-4100

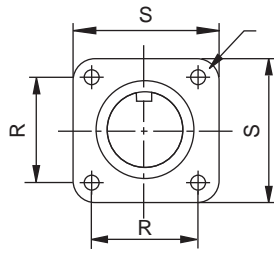
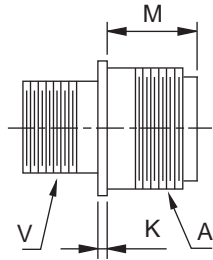

MOUNTING HOLES
 4.39 DIA. FOR SIZE 32 AND 36
 3.73 DIA. FOR SIZE 24 AND 28
 3.05 DIA. FOR ALL OTHER SIZES
 4.55 DIA. FOR 40 SIZE

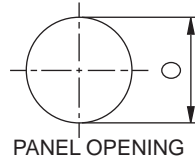

All dimensions are in mm

Connector Size	A Thread in inches	K	M	O	R	S	V Thread in inches
10SL	5/8-24 UNEF	1.98	14.29	20.62	18.25	25.68	5/8-24 NEF
12S	3/4-20 UNEF	1.98	14.29	20.62	20.64	27.76	11/16-24NEF
12	3/4-20 UNEF	1.98	19.05	20.62	20.64	27.76	11/16-24NEF
14S	7/8-20 UNEF	1.98	14.29	23.82	23.02	30.43	3/4-20 UNEF
14	7/8-20 UNEF	1.98	19.05	23.82	23.02	30.43	3/4-20 UNEF
16S	1-20 UNEF	1.98	14.29	26.97	24.61	32.82	7/8-20 UNEF
16	1-20 UNEF	3.17	19.05	26.97	24.61	32.82	7/8-20 UNEF
18	1 1/8-18 UNEF	3.17	19.05	30.17	26.99	35.07	1-20 UNEF
20	1 1/4-18 UNEF	3.17	19.05	33.32	29.37	38.38	1 1/8-18 NS
22	1 3/8-18 UNEF	3.17	19.05	36.52	31.75	41.55	1 1/4-18 NEF
24	1 1/2-18 UNEF	3.17	20.64	39.67	34.92	44.70	1 3/8-18 NEF
28	1 3/4-18 UNS	3.17	20.64	46.02	39.69	51.08	1 5/8-18 NEF
32	2.00-18 UNS	3.17	22.25	53.0	44.45	57.15	1 7/8-16UN
36	2 1/4-16 UN	3.17	22.22	58.72	49.21	63.78	2 1/16-16UN
40	2 1/2-16 UN	3.45	22.22	62.00	55.58	69.85	2 5/16-16 UN

Cable Connecting Receptacle
MS-3101 MS-4101

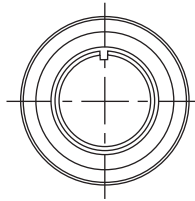
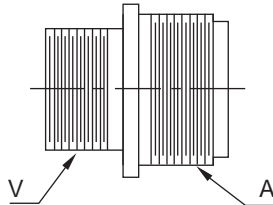

All dimensions are in mm

Connector Size	A Thread in inches	V Thread in inches
10SL	5/8-24 UNEF	5/8-24 NEF
12S	3/4-20 UNEF	11/16-24 NEF
12	3/4-20 UNEF	11/16-24 NEF
14S	7/8-20 UNEF	3/4-20 UNEF
14	7/8-20 UNEF	3/4-20 UNEF
16S	1-20 UNEF	7/8-20 UNEF
16	1-20 UNEF	7/8-20 UNEF
18	1 1/8-18 UNEF	1-20 UNEF
20	1 1/4-18 UNEF	1 1/8-18 NS
22	1 3/8-18 UNEF	1 1/4-18 NEF
24	1 1/2-18 UNEF	1 3/8-18 NEF
28	1 3/4-18 UNS	1 5/8-18 NEF
32	2-18 UNS	1 7/8-16UN
36	2 1/4-16 UN	2 1/16-16UN
40	2 1/2-16 UN	2 5/16-16 UN

Shell Types
Box mounting receptacle
MS-3102 MS-4102

MOUNTING HOLES
 4.39 DIA. FOR SIZE 32 AND 36
 3.73 DIA. FOR SIZE 24 AND 28
 3.05 DIA. FOR ALL OTHER SIZES
 4.55 FOR 40 SIZE

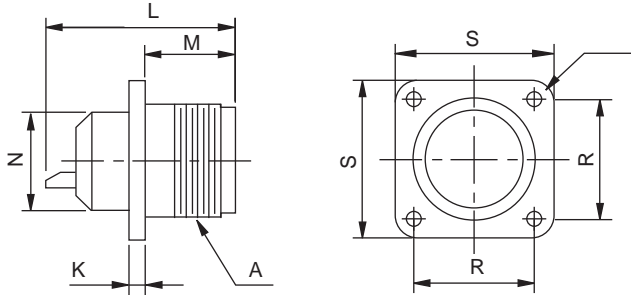

All dimensions are in mm

Connector Size	A Thread in inches	K	L	M	N	R	S
10SL	5/8-24 UNEF	1.98	30.18	13.89	15.87	18.25	25.68
12S	3/4-20 UNEF	1.98	30.18	14.28	17.46	20.64	28.04
12	3/4-20 UNEF	1.98	41.28	19.05	17.46	20.64	28.04
14S	7/8-20 UNEF	1.98	30.18	14.28	19.05	23.02	30.43
14	7/8-20 UNEF	1.98	41.28	19.05	19.05	23.02	30.43
16S	1-20 UNEF	1.98	30.18	14.28	22.22	24.61	32.82
16	1-20 UNEF	3.17	41.28	19.05	22.22	24.61	32.82
18	1 1/8-18 UNEF	3.17	49.28	19.05	25.40	26.99	35.08
20	1 1/4-18 UNEF	3.17	49.28	19.05	28.57	29.37	38.38
22	1 3/8-18 UNEF	3.17	49.28	19.05	31.75	31.75	41.55
24	1 1/2-18 UNEF	3.17	49.28	20.64	34.92	34.92	44.73
28	1 3/4-18 UNS	3.17	49.28	20.64	41.27	39.69	51.08
32	2-18 UNS	3.17	49.28	22.22	48.26	44.45	57.15
36	2 1/4-16 UN	3.17	49.28	22.22	53.97	49.21	63.78
40	2 1/2-16 UN	3.45	49.28	22.22	58.25	55.58	69.85

Straight Plug
MS-3106 MS-4106

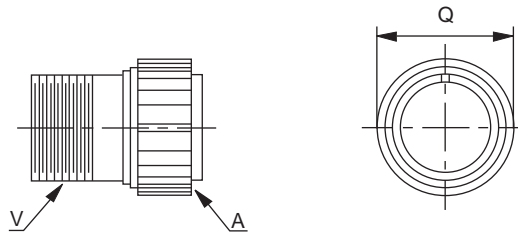

All dimensions are in mm

Connector Size	A Thread in inches	Q max	V Thread in inches
10SL	5/8-24 UNEF	19.05	5/8-24 NEF
12S	3/4-20 UNEF	19.84	11/16-24NEF
12	3/4-20 UNEF	19.84	11/16-24NEF
14S	7/8-20 UNEF	22.22	3/4-20 UNEF
14	7/8-20 UNEF	22.22	3/4-20 UNEF
16S	1-20 UNEF	25.40	7/8-20 UNEF
16	1-20 UNEF	25.40	7/8-20 UNEF
18	1 1/8-18 UNEF	28.57	1-20 UNEF
20	1 1/4-18 UNEF	31.75	1 1/8-18 NS
22	1 3/8-18 UNEF	34.92	1 1/4-18 NEF
24	1 1/2-18 UNEF	38.10	1 3/8-18 NEF
28	1 3/4-18 UNS	44.45	1 5/8-18 NEF
32	2-18 UNS	51.75	1 7/8-16UN
36	2 1/4-16 UN	57.15	2 1/16-16UN
40	2 1/2-16 UN	63.50	2 5/16-20 UN

Note - Both versions, straight and diamond knurling available on coupling ring. For details, contact factory.

Shell Types
Right angle plug
MS-3108 MS-4108

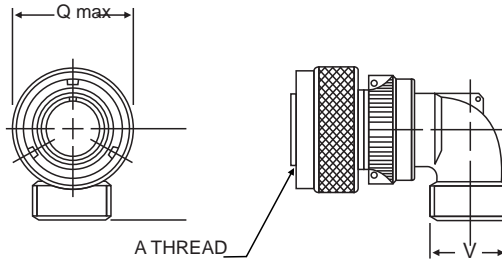

All dimensions are in mm

Connector Size	A Thread in inches	Q max	V Thread in inches
10SL	5/8-24 UNEF	19.05	5/8-24 NEF
12S	3/4-20 UNEF	19.84	11/16-24 NEF
12	3/4-20 UNEF	19.84	11/16-24 NEF
14S	7/8-20 UNEF	22.22	3/4-20 UNEF
14	7/8-20 UNEF	22.22	3/4-20 UNEF
16S	1-20 UNEF	25.40	7/8-20 UNEF
16	1-20 UNEF	25.40	7/8-20 UNEF
18	1 1/8-18 UNEF	28.57	1-20 UNEF
20	1 1/4-18 UNEF	31.75	1 1/8-18 NS
22	1 3/8-18 UNEF	34.92	1 1/4-18 NEF
24	1 1/2-18 UNEF	38.10	1 3/8-18 NEF
28	1 3/4-18 UNS	44.45	1 5/8-18 NEF
32	2-18 UNS	51.75	1 29/32-18 NS
36	2 1/4-16 NS	57.15	2 1/16-20 UNS
40	2 1/2-16 UN	63.50	2 5/16-16 UN

Note - Both versions, straight and diamond knurling available on coupling ring. For details, contact factory.

Shell Types
Box mounting receptacle
97B-3100 97B-4100

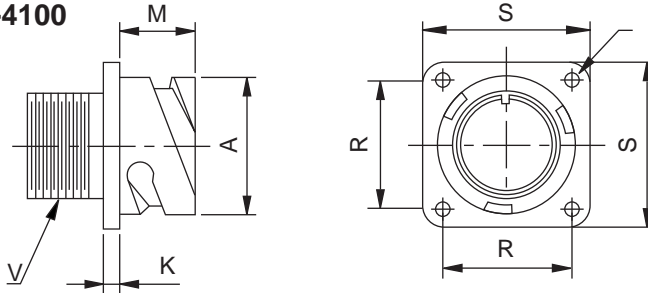

MOUNTING HOLES
 4.39 DIA. FOR SIZE 32 , 36 AND 40
 3.73 DIA. FOR SIZE 24 AND 28
 3.05 DIA. FOR ALL OTHER SIZES

All dimensions are in mm

Connector Size	A	K	M	R	S	V Thread in inches
10SL	18.2	2.8	14.2	18.2	25.4	5/8-24 NEF
14S	24.6	3.2	14.2	23.0	30.0	3/4-20 UNEF
16S	27.4	3.2	14.2	24.6	32.5	7/8-20 UNEF
16	27.4	3.2	19.0	24.6	32.5	7/8-20 UNEF
18	30.8	4.0	19.0	27.0	35.0	1-20 UNEF
20	34.2	4.0	19.0	29.4	38.0	1 1/8-24 NS
22	37.4	4.0	19.0	31.8	41.0	1 1/4-18 NEF
24	40.9	4.0	20.6	34.9	44.5	1 3/8-18 NEF
28	46.7	4.0	20.6	39.7	50.8	1 5/8-18 NEF
32	53.4	4.0	22.2	44.5	57.0	1 7/8-16UN
36	59.6	4.0	22.2	49.2	63.5	2 1/16-16UN
40	65.5	4.0	22.2	55.5	69.85	2 5/16-16 UN

Cable Connecting Receptacle
97B-3101 97B-4101

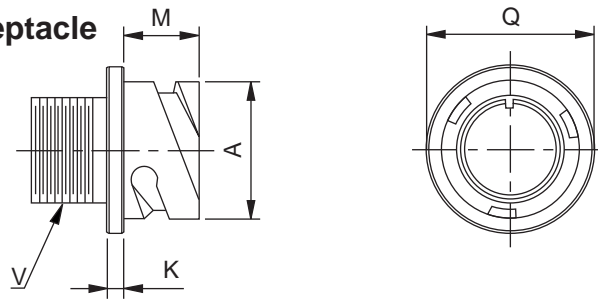

All dimensions are in mm

Connector Size	A	K	M	V Thread in inches
10SL	18.2	2.8	14.2	5/8-24 NEF
14S	24.6	3.2	14.2	3/4-20 UNEF
16S	27.4	3.2	14.2	7/8-20 UNEF
16	27.4	3.2	19.0	7/8-20 UNEF
18	30.8	4.0	19.0	1-20 UNEF
20	34.2	4.0	19.0	1 1/8-24 NS
22	37.4	4.0	19.0	1 1/4-18 NEF
24	40.9	4.0	20.6	1 3/8-18 NEF
28	46.7	4.0	20.6	1 5/8-18 NEF
32	53.4	4.0	22.2	1 7/8-16UN
36	59.6	4.0	22.2	2 1/16-16UN
40	65.5	4.0	22.2	2 5/16-16 UNS

Shell Types

Front box mounting receptacle
97B-3102 97B-4102

MOUNTING HOLES
4.39 DIA. FOR SIZE 32 ,36 AND 40
3.73 DIA. FOR SIZE 24 AND 28
3.05 DIA. FOR ALL OTHER SIZES

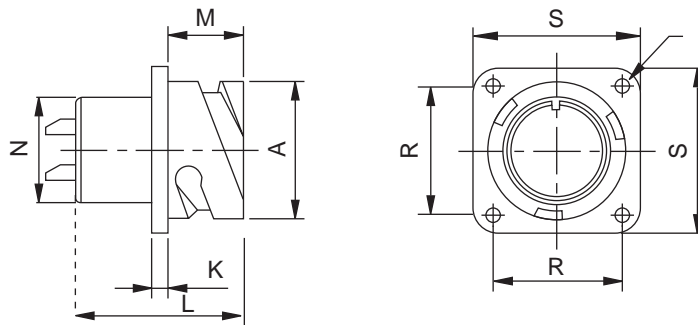

All dimensions are in mm

Connector Size	A	K	M	R	S	N max	L max
10SL	18.2	2.8	14.2	18.2	25.4	15.9	24.7
14S	24.6	3.2	14.2	23.0	30.0	19.2	24.7
16S	27.4	3.2	14.2	24.6	32.5	22.4	24.7
16	27.4	3.2	19.0	24.6	32.5	22.4	33.8
18	30.8	4.0	19.0	27.0	35.0	25.6	34.5
20	34.2	4.0	19.0	29.4	38.0	29.0	34.5
22	37.4	4.0	19.0	31.8	41.0	32.2	34.5
24	40.9	4.0	20.6	34.9	44.5	35.3	35.7
28	46.7	4.0	20.6	39.7	50.8	41.4	35.7
32	53.4	4.0	22.2	44.5	57.0	47.8	37.3
36	59.6	4.0	22.2	49.2	63.5	52.4	37.3
40	65.5	4.0	22.2	55.5	69.85	58.70	37.3

Back Box Mounting Receptacle
97B-3103 97B-4103

MOUNTING HOLES
 4.39 DIA. FOR SIZE 32 , 36 AND 40
 3.73 DIA. FOR SIZE 24 AND 28
 3.05 DIA. FOR ALL OTHER SIZES

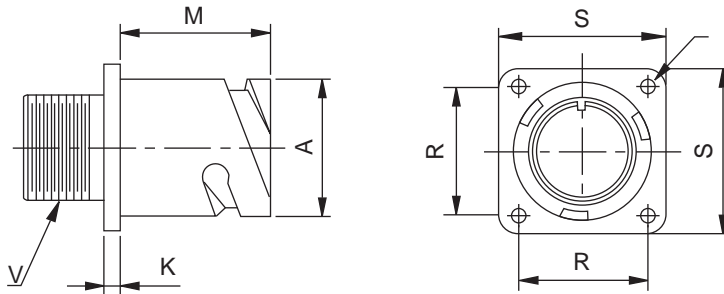

All dimensions are in mm

Connector Size	A	K	M	R	S	V Thread in inches
10SL	18.2	2.8	18.2	18.2	25.4	5/8-24 NEF
14S	24.6	3.2	18.2	23.0	30.0	3/4-20 UNEF
16S	27.4	3.2	18.2	24.6	32.5	7/8-20 UNEF
16	27.4	3.2	21.5	24.6	32.5	7/8-20 UNEF
18	30.8	4.0	23.05	27.0	35.0	1-20 UNEF
20	34.2	4.0	23.05	29.4	38.0	1 1/8-24 NS
22	37.4	4.0	23.05	31.8	41.0	1 1/4-18 NEF
24	40.9	4.0	23.05	34.9	44.5	1 3/8-18 NEF
28	46.7	4.0	24.05	39.7	50.8	1 5/8-18 NEF
32	53.4	4.0	24.05	44.5	57.0	1 7/8-16UN
36	59.6	4.0	24.05	49.2	63.5	2 1/16-16UN
40	65.5	4.0	24.05	55.5	69.85	2 5/16-16 UN-2A

Shell Types

Straight plug

97B-3106 97B-4106

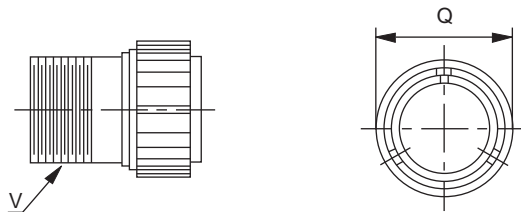

All dimensions are in mm

Connector Size	Q max	V Thread in inches
10SL	22.8	5/8-24 NEF
14S	29.2	3/4-20 UNEF
16S	32.0	7/8-20 UNEF
16	32.0	7/8-20 UNEF
18	36.5	1-20 UNEF
20	39.9	1 1/8-18 NS
22	43.1	1 1/4-18 NEF
24	46.6	1 3/8-18 NEF
28	53.4	1 5/8-18 NEF
32	60.1	1 7/8-16UN
36	66.3	2 1/16-16UN
40	69.10	2 5/16-16 UN

Right Angle Plug
97B-3108 97B-4108

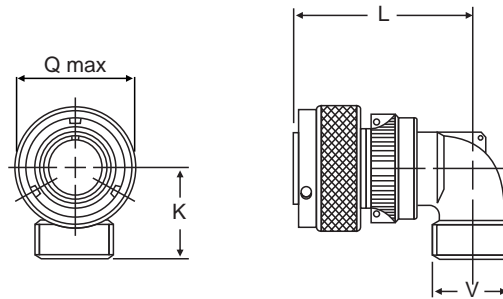

All dimensions are in mm

Connector Size	Q max	V Thread in inches	L max	K max
10SL	22.8	5/8-24 NEF	45	30
14S	29.2	3/4-20 UNEF	47	30
16S	32.0	7/8-20 UNEF	48	30
16	32.0	7/8-20 UNEF	57	35
18	36.5	1-20 UNEF	58	35
20	39.9	1 1/8-18 NS	61	35
22	43.1	1 1/4-18 NEF	61	35
24	46.6	1 3/8-18 NEF	66	40
28	53.4	1 5/8-18 NEF	66	40
32	60.1	1 29/32-18 NS	72	45
36	66.3	2 1/16-20 UNS	75	50
40	69.10	2 5/16-16 UN	78	55

Note - Both versions, straight and diamond knurling available on coupling ring. For details, contact factory.

Shell Types
Jam nut receptacle
97B - 3107R 97B-4107R

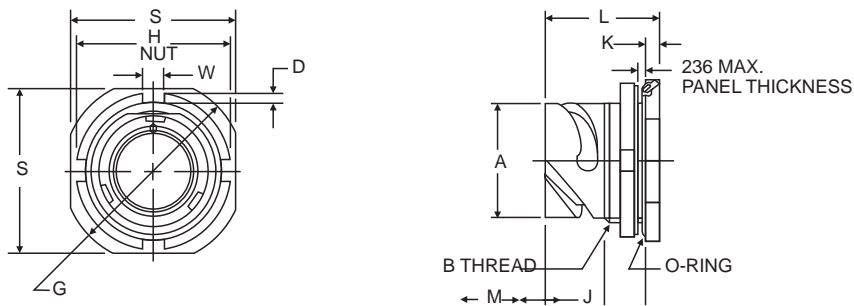

All dimensions are in mm

Shell Size	A Ref.	D Ref.	G Ref.	H Ref.	J Ref.	K Ref.	L Ref.	M Ref.	S ± 0.3	W Ref.
10SL	18.2	2.5	35.0	31.5	13.5	3.2	29.2	12.5	31.8	5.0
14S	24.6	2.5	41.3	37.9	13.5	3.2	29.2	12.5	38.1	6.0
16S	27.4	2.5	44.4	41.0	13.5	3.2	29.2	12.5	41.2	6.0
16	27.4	2.5	44.4	41.0	13.5	3.2	37.7	21.0	41.2	6.0
18	30.8	3.0	48.2	44.8	15.0	4.0	40.0	21.0	45.0	7.0
20	34.1	3.0	52.4	49.0	15.0	4.0	40.0	21.0	49.2	7.0
22	37.3	3.0	55.5	52.2	15.0	4.0	40.0	21.0	52.4	7.0
24	40.8	3.0	59.0	55.0	15.0	4.0	40.0	21.0	55.2	7.0
28	46.7	3.0	66.0	62.0	15.0	4.0	40.0	21.0	62.2	7.0
32	53.3	3.0	72.0	68.0	15.0	4.0	40.0	21.0	68.2	7.0
36	59.6	3.0	80.0	75.0	15.0	4.0	40.0	21.0	75.2	8.0

Shell Types
Jam nut receptacle
97B - 3107 97B-4107

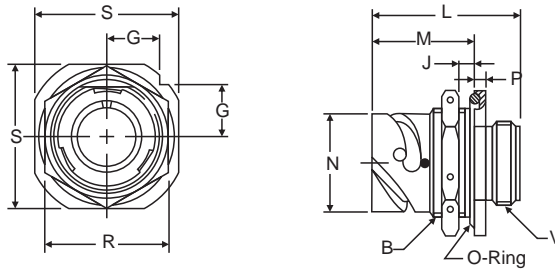

All dimensions are in mm

Shell Size	G ± 0.3	J Wall Thickness		L ±0.3	M ±0.3	N +0.00 -0.15	P ±0.2	R ±0.4	S ±0.3	Thread in inches
		Min.	Max.							
10SL	11.2	2.4	5.2	36.2	24.5	18.2	4.0	27	31.8	5/8-24 NEF
14S	14.6	2.4	7.5	38.9	26.8	24.6	4.8	33	41.3	3/4-20 UNEF
16S	15.7	2.4	7.5	38.9	26.8	27.4	4.8	38	44.4	7/8-20 UNEF
16	15.7	2.4	7.5	48.5	32.1	27.4	4.8	38	44.4	7/8-20 UNEF
18	16.8	2.4	9.0	49.3	33.7	30.8	4.8	40	47.6	1-20 UNEF
20	18.0	2.4	9.1	49.3	33.7	34.2	4.8	44	50.8	1 1/8-18 NS
22	20.0	2.4	9.1	49.3	33.7	37.4	4.8	51	57.2	1 1/4-18 NEF
24	20.2	2.4	9.1	49.6	33.7	40.9	4.8	51	57.2	1 3/8-18 NEF
28	22.5	2.4	10.0	51.9	35.2	46.7	5.6	56	63.5	1 5/8-18 NEF
32	24.7	2.4	10.0	51.9	35.2	53.4	5.6	62	69.8	1 7/8-16UN
36	26.9	2.4	8.3	51.9	35.2	59.6	5.6	71	76.2	2 1/16-20 UNS
40	29.6	2.4	8.3	51.9	35.2	65.5	5.6	76	82.5	2 5/16-16 UN

Shell Types
Panel mounting plug connector
97B - 3110A 97B-4110A

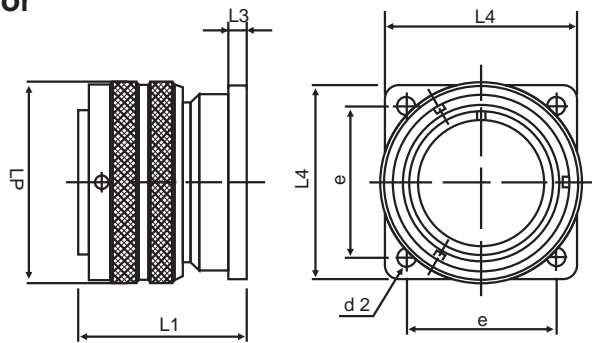

All dimensions are in mm

Shell Size	d ₁ Max	d ₂ H13	e ±0.1	l ₁ ~	l ₃ ±0.2	l ₄ ±0.3
10SL	22.8	3.2	18.2	28.1	2.8	25.4
14S	29.2	3.2	23	28.1	3.2	30
16S	32	3.2	24.6	28.1	3.2	32.5
16	32	3.2	24.6	37.6	3.2	32.5
18	36.5	3.2	27	38.6	4	35
20	39.9	3.2	29.4	38.6	4	38
22	43.1	3.2	31.8	38.6	4	41
24	46.6	3.7	34.9	41	4	44.5
28	53.4	3.7	39.7	41.8	4	50.8
32	60.1	4.3	44.5	45	4	57
36	66.3	4.3	49.2	45	4	63.5
40	72.5	4.3	55.5	45	4	69.9

Back Accessories

Solid backshell without grommet and sleeve

Class A

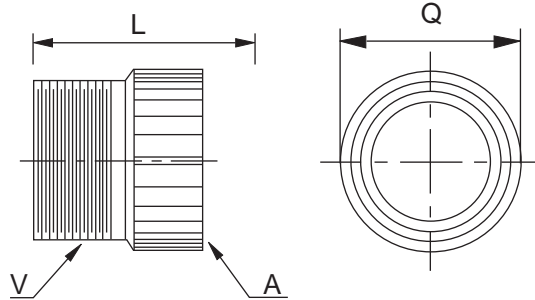

All dimensions are in mm

Connector Size	A Thread in inches	L max for MS	L max for 97B	Q max	V Thread in inches
10SL	5/8-24 NEF	32.54	37.60	19.05	5/8-24 UNEF
12S	11/16-24 NEF	37.31	---	19.84	5/8-24 UNEF
12	11/16-24 NEF	46.83	---	19.84	5/8-24 UNEF
14S	3/4-20 UNEF	36.51	37.64	22.22	3/4-20 UNEF
14	3/4-20 UNEF	46.83	---	22.22	3/4-20 UNEF
16S	7/8-20 UNEF	37.70	38.83	25.40	7/8-20 UNEF
16	7/8-20 UNEF	48.02	48.00	25.40	7/8-20 UNEF
18	1-20 UNEF	50.80	51.58	28.57	1-20 UNEF
20	1 1/8-18 NS	53.97	54.75	31.75	1 3/16-18 UNEF
22	1 1/4-18 NEF	53.97	54.75	34.92	1 3/16-18 UNEF
24	1 3/8-18 NEF	57.15	57.94	38.10	1 7/16-18 UNEF
28	1 5/8-18 NEF	57.15	57.94	44.45	1 7/16-18 UNEF
32	1 7/8-16UN	59.0	59.78	51.75	1 3/4-18 UNS
36	2 1/16-16UN	60.32	61.13	57.15	2-18 UNS
40	2 5/16-16 UN	71.80	80.00	63.50	2 1/4 - 16 UN

Solid Backshell With Grommet & Sleeve

Class R

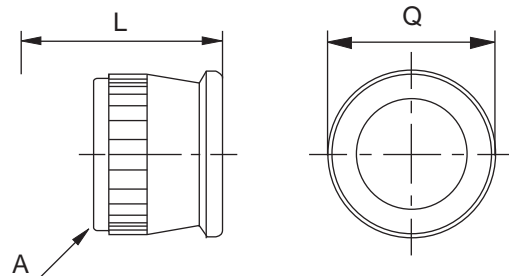

All dimensions are in mm

Connector Size	A Thread class 2B in inches	For Plug type L max for MS	For Receptacle L max for 97B	Q max
10SL	5/8-24 NEF	47	48	21.50
12S	11/16-24 NEF	47	---	20.35
12	11/16-24 NEF	55	---	20.35
14S	3/4-20 UNEF	47	48	23.40
14	3/4-20 UNEF	55	---	23.40
16S	7/8-20 UNEF	47	48	26.71
16	7/8-20 UNEF	55	56	26.71
18	1-20 UNEF	57	57	29.50
20	1 1/8-18 NS	57	57	35.70
22	1 1/4-18 NEF	57	57	35.85
24	1 3/8-18 NEF	57	57	44.40
28	1 5/8-18 NEF	57	57	45.08
32	1 7/8-16UN	58.25	60	52.36
36	2 1/16-16UN	58.25	60	56.81
40	2 5/16-16 UN	58.25	60	64.50

Note - Both versions, straight and diamond knurling available on back accessories. For details, contact factory.

Back Accessories
Strain relief backshell with grommet and sleeve
Class E and F

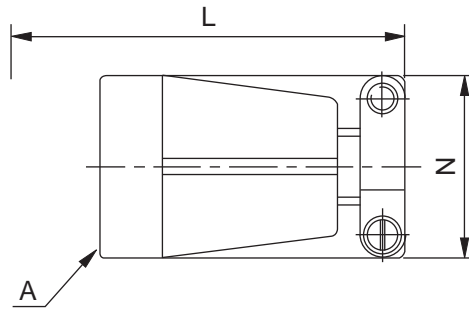

All dimensions are in mm

Connector Size	A Thread class 2B in inches	L max for MS	L max for 97B	N max
10SL	5/8-24 NEF	54.07	59.10	21.97
12S	11/16-24 NEF	54.07	---	21.97
14S	3/4-20 UNEF	55.90	61.34	25.15
16S	7/8-20 UNEF	55.90	62.86	28.45
16	7/8-20 UNEF	64.41		28.45
18	1-20 UNEF	65.94	71.10	30.76
20	1 1/8-18 NS	67.41	72.55	37.29
22	1 1/4-18 NEF	67.41	72.55	37.29
24	1 3/8-18 NEF	73.28	76.82	44.45
28	1 5/8-18 NEF	73.28	77.82	44.45
32	1 7/8-16UN	74.75		52.22
36	2 1/16-16UN	74.75	77.64	57.15
40	2 5/16-16 UN	86.0	125.0	67.10

Right Angle Backshell With Or Without Grommet
Class A, F & R

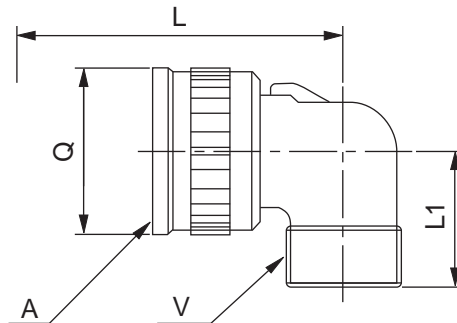

All dimensions are in mm

Connector Size	A Thread class 2B in inches	L max for MS	L max for 97B	L1 max	Q max	V Thread in inches
10SL	5/8-24 NEF	37.60	45.00	25.00	22.22	5/8-24 UNEF
12S	11/16-24 NEF	37.80	---	25.00	25.40	5/8-24 UNEF
12	11/16-24 NEF	47.30	---	25.00	25.40	5/8-24 UNEF
14S	3/4-20 UNEF	39.40	47.00	27.00	28.57	3/4-20 UNEF
14	3/4-20 UNEF	48.90	---	27.00	28.57	3/4-20 UNEF
16S	7/8-20 UNEF	42.60	48.00	28.00	31.75	7/8-20 UNEF
16	7/8-20 UNEF	52.10	57.00	28.00	31.75	7/8-20 UNEF
18	1-20 UNEF	53.70	58.00	31.00	34.13	1-20 UNEF
20	1 1/8-18 NS	58.80	61.00	34.00	37.30	1 3/16-18 UNEF
22	1 1/4-18 NEF	58.80	61.00	34.00	40.48	1 3/16-18 UNEF
24	1 3/8-18 NEF	63.60	66.00	37.00	43.66	1 7/16-18 UNEF
28	1 5/8-18 NEF	63.60	66.00	39.00	50.00	1 7/16-18 UNEF
32	1 7/8-16UN	69.60	72.00	45.00	56.50	1 3/4-18 UNS
36	2 1/16-16UN	72.80	75.00	48.00	62.71	2-18 UNS
40	2 5/16-26 UN	76.00	78.00	55.00	62.71	2 1/4 -16 UN

Note - Both versions, straight and diamond knurling available on back accessories. For details, contact factory.

PG Adaptor

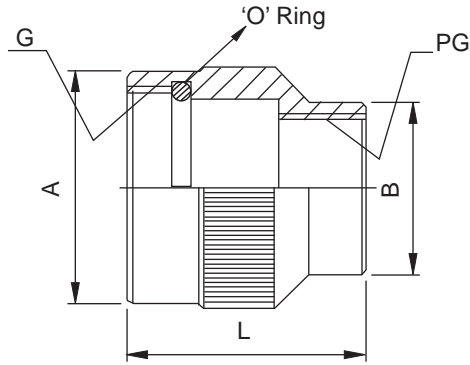

Shell size	G Thread in inches	PG 9			PG 11			PG 13			PG 16			PG 21			PG 29			PG 36			
		A	B	L	A	B	L	A	B	L	A	B	L	A	B	L	A	B	L	A	B	L	
10SL	5/8-24																						
12S	11/16-24																						
14	3/4-20				23	23	30	23	23	30													
16	7/8-20				25	25	30				25	25	30										
18	1-20	30	21	26	30	26	37				30	28	37										
20	1 1/8-18				35	26	40				35	28	40	35	35	40							
22	1 1/4-18										35	28	40	35	35	40							
24	1 3/8-18													38	35	40	40	40	40				
28	1 5/8-18													45	37	45	45	45	45				
36	2 1/8-18																57	44	55	57	57	55	

Ordering Information
 MS - XX-PGYY
 Where XX- Shell Size
 YY-PG-Thread Size

EGM/PHM Backshell Accessories

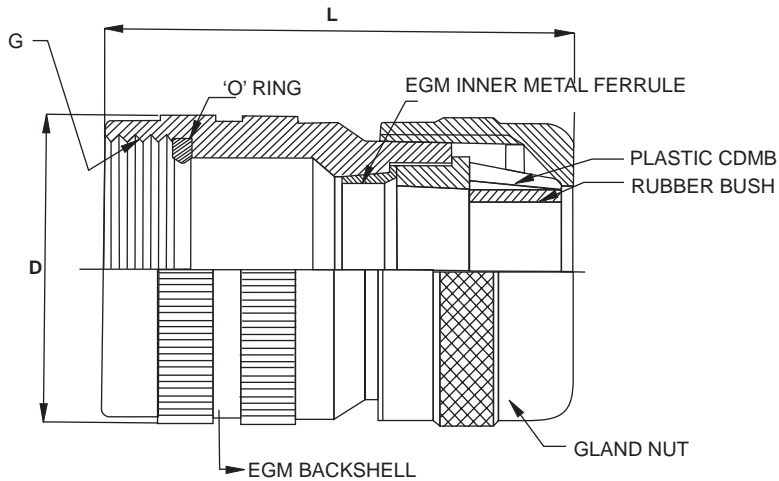

Shell size	G Thread in inches	EGM/PHM 11		EGM/PHM 21	
		D	L	D	L
10SL	5/8"-24	25.00	37.00	27.00	41.00
12SL	16/16"-24	25.00	37.00	27.00	41.00
14	3/4"-20	25.00	37.00	27.00	41.00
16	7/8"-20	25.00	40.00	27.00	43.00
18	1"-20	29.00	40.00	31.00	43.00
20	1.1/8"-18	31.50	52.00	33.50	55.00
22	1.1/4"-18	35.00	60.00	35.00	60.00
24	1.3/8"-18	35.00	60.00	35.00	60.00
32	1.29/32"-18	52.00	70.00	52.00	70.00
36	2.1/6"-18	52.00	70.00	52.00	70.00

Note:- Rubber Bush supplied in Packing
 In case of PHM inner metal Furrele is not required/supplied

**Heat Shrink
Boot adaptor (G)**

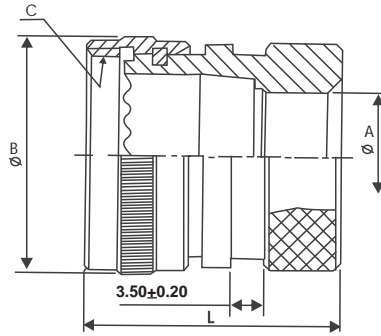

Shell size	A Min.	B	L Max.	C- THD
10SL	7.70	20.30	30.00	5/8-24 NEF
12S	8.20			
14S	10.60	22.30	27.00	3/4-20 UNEF
16S	13.50	24.80	29.50	7/8-20 UNEF
16				
18	14.60	28.50	33.50	1-20 UNEF
20	18.70	34.50		1 1/8-18 NEF
22	20.80	35.10	35.70	1 1/4-18 UNEF
24	24.60	41.00	34.00	1 3/8-18 NEF
28	27.00	44.80	34.10	1 5/8-18 NEF
32	33.30	51.50	34.20	1 7/8-16 UN
36	38.50	56.00	34.20	2 1/16-16 UN
40	48.20	62.00	36.60	2 5/16-16 UN

Back Accessories

Cable clamp

MS-3057

Use MS-3420 sleeves

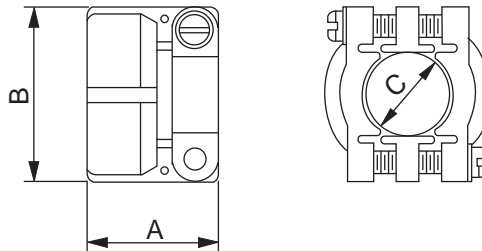

All dimensions are in mm

Part number	Shell size	Max OD of cable	A	B	C	Thread in inches
MS-3057-4A	10SL, 12S	5.59	20.90	21.39	7.94	5/8-24
MS-3057-6A	14, 14S	7.92	21.59	25.27	11.11	3/4-20
MS-3057-8A	16, 16S	11.10	23.37	28.45	14.29	7/8-20
MS-3057-10A	18	14.27	23.37	30.89	15.87	1-20
MS-3057-12A	20,22	15.87	23.07	35.03	19.50	1 3/16-18
MS-3057-16A	24,28	19.05	25.78	42.75	23.81	1 7/16-18
MS-3057-20A	32	23.80	28.00	51.00	31.70	1 3/4-18
MS-3057-24A	36	31.75	29.36	57.02	34.92	2-18

**Neoprene Sleeve
MS-3420**

Rubber bushing. Protects wire bundles and unjacketed cables from possible damage by cable clamp.

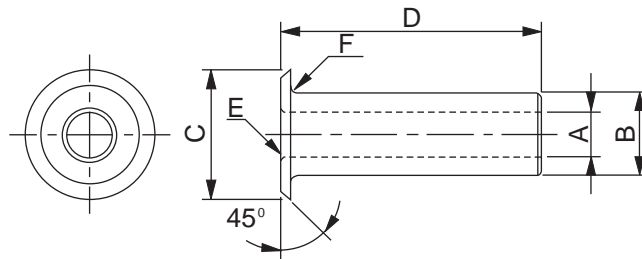

All dimensions are in mm

Part number	A	B	C	D	E Rad in inches	F Rad in inches
MS-3420-3	3.30	5.33	9.50	73.02	0.79	0.79
MS-3420-4	5.59	7.67	12.70	69.85	0.79	0.79
MS-3420-6	7.92	10.84	15.59	66.67	0.79	1.59
MS-3420-8	11.10	14.02	18.77	63.50	1.59	1.59
MS-3420-10	14.27	15.62	21.94	60.32	1.59	1.59
MS-3420-12	15.87	18.80	26.23	56.20	1.59	1.59
MS-3420-16	19.05	23.54	26.39	53.97	1.59	1.59
MS-3420-20	23.80	31.50	40.41	50.80	1.59	1.59
MS-3420-24	31.75	34.67	46.79	47.62	1.59	1.59

Other Accessories

Plain flat gasket

For MS and 97B flange mounted receptacles

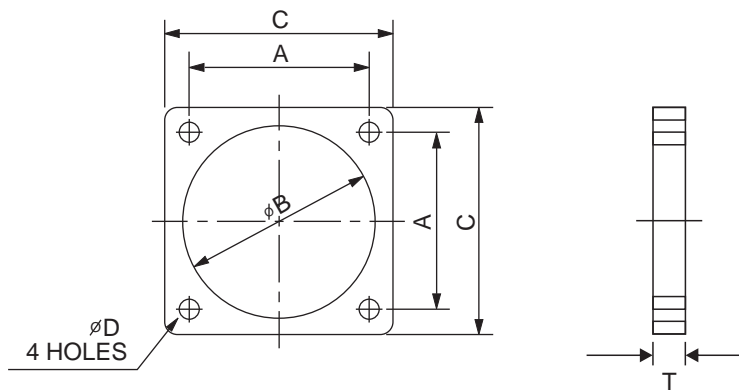

All dimensions are in mm

Part number	Shell size	A max	B	C	D	T
MS-101000	10SL	18.26	15.90	25.40	4.35	1.5
MS-108686	12S & 12	20.62	19.05	27.80	4.35	1.5
MS-101001	14S & 14	23.01	22.20	30.15	4.35	1.5
MS-101002	16S & 16	24.61	25.40	32.50	4.35	1.5
MS-101003	18	27.00	28.57	34.90	5.15	1.5
MS-101004	20	29.36	31.75	38.10	5.15	1.5
MS-101005	22	31.75	34.90	41.20	5.15	1.5
MS-108687	24	34.90	38.10	44.45	5.15	1.5
MS-101006	28	39.70	44.45	50.80	5.15	1.5
MS-108688	32	44.45	50.80	57.15	5.55	1.5
MS-101007	36	49.22	55.57	63.50	5.55	1.5
MS-110831	40	55.77	61.92	69.85	5.55	1.5

**Protective Cap For MS Series
MS-25043**

For receptacles Has internal threads and is used on all receptacles. Gasket is provided in the dust cap forming a watertight seal.

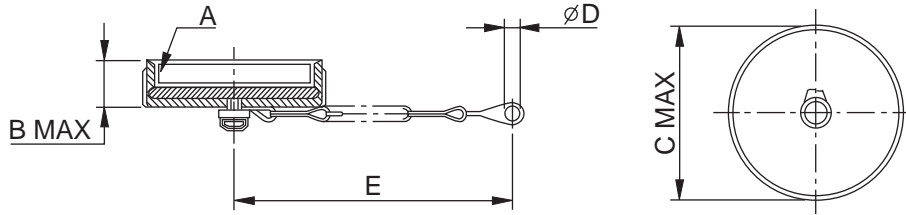

All dimensions are in mm

MS Part number	Shell size	A Thread in inches	B	C	D	E
MS 25043-10D	MS 10S-1-SL	5/8-24	11.11	20.7	3.6	102
MS 25043-12D	MS 12-12S	3/4- 20	11.11	25.4	3.6	115
MS 25043-14D	MS 14-14S	7/8-20	11.11	28.6	3.6	115
MS 25043-16D	MS 16-16S	1-20	11.11	30.2	3.6	115
MS 25043-18D	MS 18	1 1/8-18	11.11	34.1	3.6	115
MS 25043-20D	MS 20	1 1/4-18	11.11	37.3	4.4	127
MS 25043-22D	MS 22	1 3/8-18	11.11	40.4	4.4	127
MS 25043-24D	MS 24	1 1/2-18	11.11	43.6	4.4	140
MS 25043-28D	MS 28	1 3/4-18	12.7	50	4.4	197
MS 25043-32D	MS 32	2-18	12.7	56.3	4.8	197
MS 25043-36D	MS 36	2 1/4-18	12.7	62.7	4.8	197
MS 25043-40D	MS 40	2 1/2-16	12.7	69	4.8	197

- Notes :**
1. For protective caps with nylon cord, contact factory.
 2. Standard - Plating is Cad. For alternative finishes, contact factory.
 3. Standard - straight knurling. For diamond knurling on caps, contact factory.

**Other Accessories
Protective cap for MS series
MS-25042**

For plugs Has external threads and is used on all plugs where a coupling ring is provided.

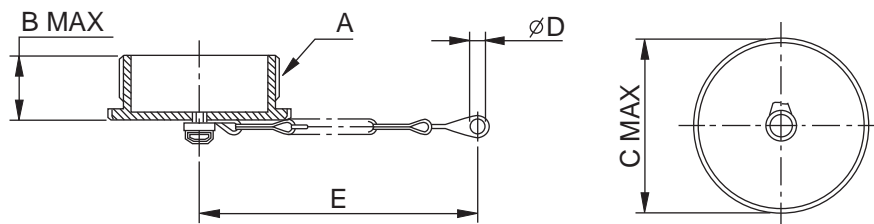

All dimensions are in mm

MS Part number	Shell size	A Thread in inches	B	C	D	E
MS 25042-10D	MS 10S-1-SL	5/8-24	16.67	17.4	4	102
MS 25042-12D	MS 12-12S	3/4- 20	21.4	20.6	4	115
MS 25042-14D	MS 14-14S	7/8-20	21.4	23.7	4	115
MS 25042-16D	MS 16-16S	1-20	21.4	26.9	4	115
MS 25042-18D	MS 18	1 1/8-18	21.4	30	4	115
MS 25042-20D	MS 20	1 1/4-18	21.4	33	4.8	127
MS 25042-22D	MS 22	1 3/8-18	21.4	36.4	4.8	127
MS 25042-24D	MS 24	1 1/2-18	21.4	39.6	4.8	140
MS 25042-28D	MS 28	1 3/4-18	21.4	46	4.8	197
MS 25042-32D	MS 32	2-18	21.4	52	5.6	197
MS 25042-36D	MS 36	2 1/4-18	21.4	58.7	5.6	197
MS 25042-40D	MS 40	2 1/2-16	21.4	65	5.6	197

Other Accessories
Protective cap for 97B series
97B-25042
For Plugs

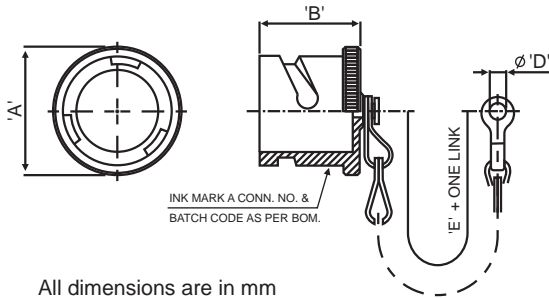

All dimensions are in mm

SHELL SIZE	'A' MAX.	'B' MAX.	'D' + 0.60/-0	'E' MIN.
10 SL	21.0	23.50	4.30	90.0
14 S	27.50			100.0
16 S	30.0			115.0
16	30.0	31.50	4.70	130.0
18	33.50			190.0
20	37.0			
22	40.0			
24	43.0			
28	49.50			
32	56.0			
36	62.50	5.50	190.0	
40	73.0			

Protective cap For 97B series
97B-25043
For Receptacle

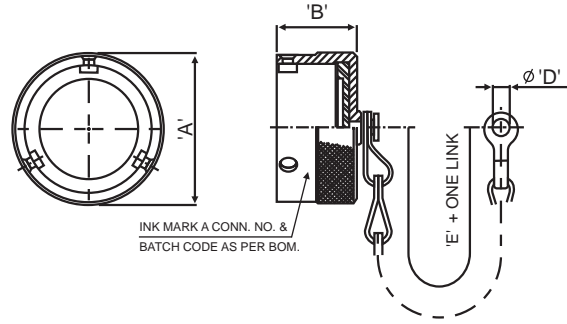

All dimensions are in mm

SHELL SIZE	'A' MAX.	'B' ± 0.20	'D' + 0.60/-0	'E' MIN.	
10 SL	23.0	16.0	4.30	90.0	
14 S	30.0				
16 S	32.50				
16	32.50	20.70	4.30	100.0	
18	37.0				115.0
20	40.50				
22	43.50			160.0	
24	47.0				
28	54.0				
32	60.50				
36	67.0	5.50	160.0		
40	73.0				

97BSS-25042-20-622-LXX-G

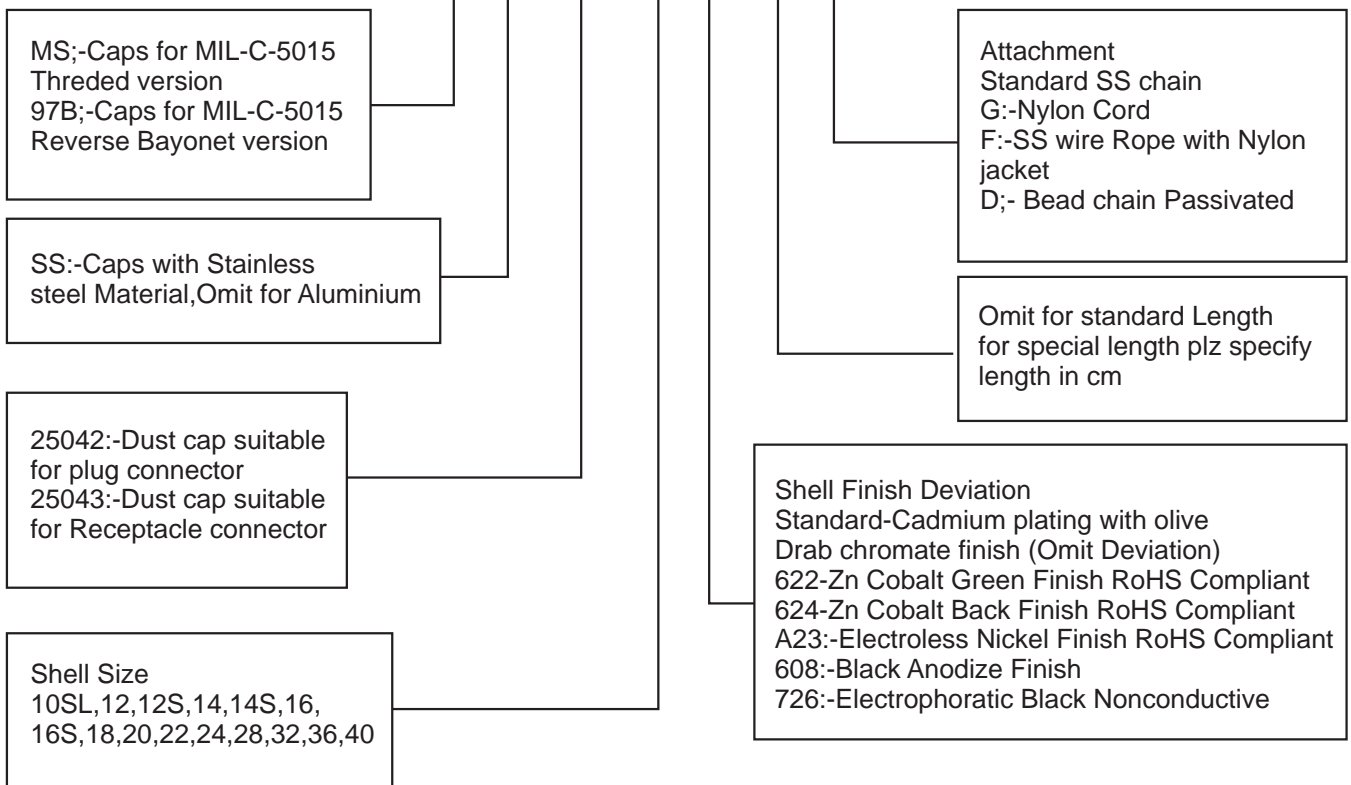

Other Accessories

Dummy receptacle

MS-3105

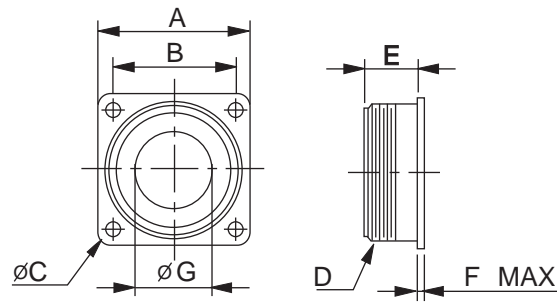

All dimensions are in mm

Part number (see note)	A	B	C	D Thread in inches	E	F max.	G
MS-3105-10S	25.4	18.26	3.05	5/8-24	14.27	3.96	8.20
MS-3105-12S	27.79	20.62	3.05	3/4-20	14.27	3.96	11.43
MS-3105-12	27.79	20.62	3.05	3/4-20	19.05	3.96	11.43
MS-3105-14S	30.17	23.01	3.05	7/8-20	14.27	3.96	13.36
MS-3105-14	30.17	23.01	3.05	7/8-20	19.05	3.96	13.36
MS-3105-16S	32.54	24.61	3.05	1-20	14.27	3.96	16.41
MS-3105-16	32.54	24.61	3.05	1-20	19.05	3.96	16.41
MS-3105-18	34.92	26.97	3.05	1 1/8-18	19.05	5.16	18.03
MS-3105-20	38.10	29.36	3.05	1 1/4-18	19.05	5.16	23.54
MS-3105-22	41.27	31.75	3.05	1 3/8-18	19.05	5.16	25.93
MS-3105-24	44.45	34.92	3.73	1 1/2-18	20.62	5.16	29.21
MS-3105-28	50.8	39.67	3.73	1 3/4-18	20.62	5.16	34.67
MS-3105-36	63.5	49.22	4.39	2 1/4-16	22.2	9.11	46.56

Note: The dash number also indicates shell size.

Special Accessories

For special accessories, please contact factory with specifications and drawings. Amphenol has in-house capability to meet and custom build your special accessories requirements for its range of MIL-C5015 MS and 97B series connectors.

For 97B - Connector Modification

- F 42 - Less grommet & backshell
- F0/LC - Less contacts
- 563 - Gold plated contacts
- T 00 - Metric threads in flange holes
- 97 BS - Bayonet Version with Steel wear pin (for receptacle connector)
- RFI - Plug connector with grounding finger
- HD - Heavy duty coupling ring

MS/97B Connector- Accessories

Crimp contact

Contacts for MS/97B connectors are machined from copper alloys and silver plated for maximum corrosion resistance, with a minimum millivolt drop and a maximum current carrying capacity; the size 16 and 12 socket contacts are of the closed entry design. Gold plated contacts are also available.

Part Number For Crimp Contacts only*	Pin/ Socket	Mating End Size	Wire Barrel Size	Allowable Wire size	Test Current*** Amps
MS-106433	Pin	16 Short†	16	16	13
MS-108456	Socket			18	10
MS-108295	Pin	16 Long	16	60	7.5
MS-110262	Socket			22**	5
MS-108388	Pin	12	12	16	13
MS-108389	Socket			18	10
				20	7.5
				22**	5
MS-108386	Pin	8	8	12	23
MS-108387	Socket			14	17
				8	46
				10**	33
MS-108384	Pin	4	4	4	80
MS-111878	Socket			6**	60
MS-112067	Pin	0	0	0	150
				1	125
MS-112068	Socket			2**	

* Solder contacts are not sold as separate items. Part numbers shown here are for crimp contacts only.

** When using wire adapter sleeve shown.

*** Contact rating as stated are test ratings only. The connector may not withstand full rated current through all contacts continuously. Please note that the electrical data given is not an establishment of electrical safety factors. This is left entirely in the designer's hands as he can best determine which peak voltage, switching surges, transients, etc. can be expected in a particular circuit.

MS/97B Connectors

Application tools

When proprietary crimp contacts are employed rather than the standard MS approved solder contacts, the following application tools are recommended for use. There is a possibility of additional crimping tools other than those included being available at present or in the future for this specific application.

TOOLING CHART

Crimping Tool	Positioner/ Turret	Insertion Tool	Removal Tool
M22520/1-01	*	11-7345	11-8250 Kit
M22520/1-01	*	11-7082	11-8250 Kit
**	**	11-8220	11-8250 Kit
**	**	11-7365-4 †	Pin 11-7370-4 † Socket 11-7674-2 †
**	**	11-7365-5 †	Pin 11-7370-5 † Socket 11-7674-3 †

* Use Daniels Turret TH29-1 or Astro Tool Co. Turret 616266

** For appropriate crimp tool and positioner refer to Pico Crimping Tool Co.

† Tools used with Arbor Press 11-7364

MS/97B Series Connectors

To obtain the specific connector required, write down the connector number from the typical example below. Only inserts shown in the availability chart shown on page 7 can be specified. Connectors are delivered with protective plastic dust covers. Include premating contact designation only if premating contact is required. The second letter in the premating contact designation stands for the actual contact position. **B** at the end of the connector number indicates telescopic bushing provided.

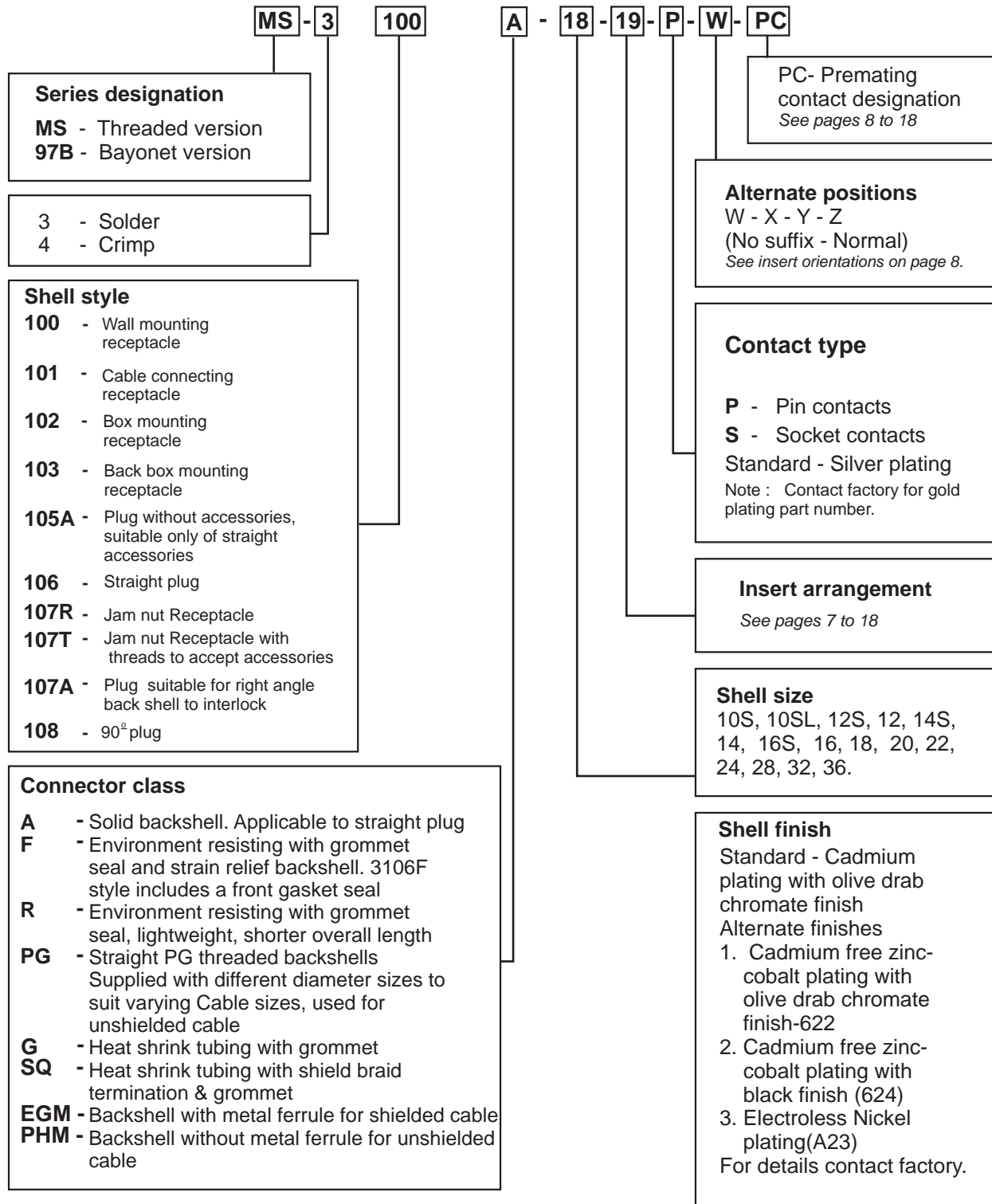

Notice : All information, including illustrations given herein is believed to be accurate at the time of printing. In lieu of design advances, Amphenol reserves the right to change specifications without notice. This publication ACR11 01-11-08 MS AND 97B Series Connectors supercedes all existing Amphenol literature on MS AND 97 B Series Connectors.

S.NO	MODIFICATION	DESCRIPTION
1	-9	No Solder Filling To Contact
2	-1	Vg Parts With Metric Contacts Crimp, Insert.shell
3	563	0.5 Micron Gold Plated Contacts
4	97BS	If added to receptacle part number connector supplied with SS wear pin
	97BS	If added to Plug part number connector supplied with Roller Stud
5	AG	A TYPE BACKSHELL ACCOMMODATE GROMMET
6	B	BUSHING MS3420-X
7	CXX	CRIMP CONTACT SUITABLE XX AWG size
8	F0/LC	LESS CONTACTS
9	F42	LESS GROMMET & BACKSHELL
10	HD	HEAVY DUTY COUPLING RING
11	LSZH	INSERT WITH LOW SMOKE ZEROMHALOGEN MATERIAL
12	PGG	PG ADAPTER WITH GLAND
13	PTC/319/320	PC TAIL CONTACT
14	RFI	PLUG CONN WITH GROUNDING FIGURE
15	SQG	SQUARE FLANGE GASKET APPLICALE TO RECEPTACLE (3100/4100/3102/4102/3103/4103)
16	SR	MS3057- XXA CABLE CLAMP
17	SRC	MS3057-XXC CABLE CLAMP
18	T 00	METRIC THD HOLES IN FLANGE
19	TBH	THRU BULKHEAD
20	M	METRIC ADAPTER
21	G	GROUNGING WIRE S/A
22	IB	INTEGRATED BACKSHELL
23	VI	VITON INSERT
24	MGXX	METRIC ADAPTER WITH GLAND
25	PME	ADAPTER WITH METRIC EXTERNAL THD
26	PGG	PG Adaptor with Gland
27	HD	Heavy duty cring
28	PCX	Premating contact X
29	F42	Connector w/o B/S

Amphenol

A Global Company



Pune Operations



Bangalore Operations

Amphenol

Interconnect India Pvt. Ltd.

Our offices in India:

MARKETING HEAD QUARTERS

105, Bhosari Industrial Area,
Pune - 411 026.
Tel.: 91- 020 - 30688303, 30688304
Fax : 91 - 020 - 30688321
Email : kmurali@amphenol-in.com
sales@amphenol-in.com

Southern Region

4931, 11th Floor, High Point IV
45, Palace Road, Bangalore 560 001.
Tel.: 91-80-22281392, 22281002
Fax : 91-80-22253859
Email : shrikantgramopadhye
@amphenol-in.com

Northern and Eastern Region

1414, 14th Floor, Chiranjiv Tower,
43, Nehru Place, New Delhi - 110 019.
Tel. : 91-11-26449177
Telefax : 91-11-26449176
Email : vbhavsar@amphenol-in.com

Export

105, Bhosari Industrial Area,
Pune - 411 026, India.
Tel.: 91- 20 - 30688305, 30688353
Fax : 91- 20 - 27129158
Email : svpatil@amphenol-in.com

Western Region

105, Bhosari Industrial Area,
Pune - 411 026.
Tel.: 91- 20 - 27119735, 30688334
Fax: 91- 20 - 27120581, 27119735
Email : sunilp@amphenol-in.com

Central Region

107, 1st Floor, 'Am Sri Classic',
Sarojinidevi Road, Secunderabad-500 003.
Telefax : 91- 40-66332906
Email : pprasad@amphenol-in.com

www.amphenol-in.com