

DFK-MC 1,5/ 5-GF-3,81 - Feed-through header



1829374

<https://www.phoenixcontact.com/in/products/1829374>

Please be informed that the data shown in this PDF document is generated from our Online Catalog. Please find the complete data in the user documentation. Our General Terms of Use for Downloads are valid.



Feed-through header, nominal cross section: 1.5 mm², color: green, nominal current: 8 A, rated voltage (III/2): 160 V, contact surface: Tin, type of contact: Pin, number of potentials: 5, number of rows: 1, number of positions: 5, number of connections: 5, product range: DFK-MC 1,5/...-GF, pitch: 3.81 mm, connection method: Solder/Slip-on connection, mounting: Direct mounting, pin layout: Linear pinning, solder pin [P]: 9.4 mm, number of solder pins per potential: 1, plug-in system: COMBICON MC 1,5, Pin connector pattern alignment: Standard, locking: Screw locking, mounting: Threaded flange, type of packaging: packed in cardboard

Your advantages

- Free choice – permanent solder connection or standardized slip-on connection
- Cable connection on the inside of the device enables flexible positioning of the panel feed-through

Commercial Data

Item number	1829374
Packing unit	50 pc
Minimum order quantity	50 pc
Sales Key	AAB
Product Key	AABWAA
Catalog Page	Page 240 (C-1-2013)
GTIN	4017918051051
Weight per Piece (including packing)	4.22 g
Weight per Piece (excluding packing)	3.959 g
Customs tariff number	85366990
Country of origin	PL

DFK-MC 1,5/ 5-GF-3,81 - Feed-through header



1829374

<https://www.phoenixcontact.com/in/products/1829374>

Technical Data

Product properties

Type	Feed-through header
Product line	COMBICON Connectors S
Product type	Feed-through header
Product family	DFK-MC 1,5/...GF
Number of positions	5
Pitch	3.81 mm
Number of connections	5
Number of rows	1
Mounting flange	Threaded flange
Number of potentials	5
Pin layout	Linear pinning
Solder pins per potential	1

Electrical properties

Nominal current I_N	8 A
Nominal voltage U_N	160 V
Degree of pollution	3
Contact resistance	2.2 mΩ
Rated voltage (III/3)	160 V
Rated surge voltage (III/3)	2.5 kV
Rated voltage (III/2)	160 V
Rated surge voltage (III/2)	2.5 kV
Rated voltage (II/2)	320 V
Rated surge voltage (II/2)	2.5 kV

Mounting

Mounting type	Direct mounting
Pin layout	Linear pinning

Flange

Tightening torque	0.3 Nm
-------------------	--------

Material specifications

Material data - contact

Note	WEEE/RoHS-compliant, free of whiskers according to IEC 60068-2-82/JEDEC JESD 201
Contact material	Cu alloy
Surface characteristics	Tin-plated
Metal surface contact area (top layer)	Tin (5 - 7 μm Sn)
Metal surface contact area (middle layer)	Nickel (2 - 3 μm Ni)
Metal surface soldering area (top layer)	Tin (5 - 7 μm Sn)

DFK-MC 1,5/ 5-GF-3,81 - Feed-through header

1829374

<https://www.phoenixcontact.com/in/products/1829374>

Metal surface soldering area (middle layer)	Nickel (2 - 3 µm Ni)
---	----------------------

Material data - housing

Color (Housing)	green (6021)
Insulating material	PA
Insulating material group	I
CTI according to IEC 60112	600
Flammability rating according to UL 94	V0

Material data – actuating element

Color ()	()
----------	----

Notes

Notes on operation	In accordance with IEC 61984, COMBICON connectors have no switching power (COC). During designated use, they must not be plugged in or disconnected when carrying voltage or under load.
--------------------	--

Dimensions

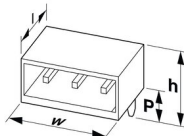
Dimensional drawing	
Pitch	3.81 mm
Width [w]	33.44 mm
Height [h]	20.4 mm
Length [l]	16.2 mm
Installed height	11 mm
Solder pin length [P]	9.4 mm

Mechanical tests

Test for conductor damage and slackening

Specification	IEC 60999-1:1999-11
Result	Test passed

Pull-out test

Specification	IEC 60999-1:1999-11
Conductor cross section/conductor type/tractive force setpoint/actual value	0.14 mm ² / solid / > 7 N
	0.14 mm ² / flexible / > 7 N
	1.5 mm ² / solid / > 40 N
	1.5 mm ² / flexible / > 40 N

Insertion and withdrawal forces

Result	Test passed
No. of cycles	25

DFK-MC 1,5/ 5-GF-3,81 - Feed-through header



1829374

<https://www.phoenixcontact.com/in/products/1829374>

Insertion strength per pos. approx.	7 N
Withdraw strength per pos. approx.	4 N

Torque test

Specification	IEC 60999-1:1999-11
---------------	---------------------

Contact holder in insert

Specification	IEC 60512-15-1:2008-05
Contact holder in insert Requirements >20 N	Test passed

Resistance of inscriptions

Specification	IEC 60068-2-70:1995-12
Result	Test passed

Polarization and coding

Specification	IEC 60512-13-5:2006-02
Result	Test passed

Visual inspection

Specification	IEC 60512-1-1:2002-02
Result	Test passed

Dimension check

Specification	IEC 60512-1-2:2002-02
Result	Test passed

Electrical tests

Thermal test | Test group C

Specification	IEC 60512-5-1:2002-02
Tested number of positions	16

Insulation resistance

Specification	IEC 60512-3-1:2002-02
Insulation resistance, neighboring positions	> 5 MΩ

Air clearances and creepage distances |

Specification	IEC 60664-1:2007-04
Insulating material group	I
Comparative tracking index (IEC 60112)	CTI 600
Rated insulation voltage (III/3)	160 V
Rated surge voltage (III/3)	2.5 kV
minimum clearance value - non-homogenous field (III/3)	1.5 mm
minimum creepage distance (III/3)	2 mm
Rated insulation voltage (III/2)	160 V
Rated surge voltage (III/2)	2.5 kV
minimum clearance value - non-homogenous field (III/2)	1.5 mm

DFK-MC 1,5/ 5-GF-3,81 - Feed-through header



1829374

<https://www.phoenixcontact.com/in/products/1829374>

minimum creepage distance (III/2)	1.5 mm
Rated insulation voltage (II/2)	320 V
Rated surge voltage (II/2)	2.5 kV
minimum clearance value - non-homogenous field (II/2)	1.5 mm
minimum creepage distance (II/2)	1.6 mm

Environmental and real-life conditions

Vibration test

Specification	IEC 60068-2-6:2007-12
Frequency	10 - 150 - 10 Hz
Sweep speed	1 octave/min
Amplitude	0.35 mm (10 Hz ... 60.1 Hz)
Sweep speed	5g (60.1 Hz ... 150 Hz)
Test duration per axis	2.5 h

Durability test

Specification	IEC 60512-9-1:2010-03
Impulse withstand voltage at sea level	2.95 kV
Contact resistance R_1	2.2 m Ω
Contact resistance R_2	2.2 m Ω
Insertion/withdrawal cycles	25
Insulation resistance, neighboring positions	> 5 M Ω

Climatic test

Specification	ISO 6988:1985-02
Corrosive stress	0.2 dm ³ SO ₂ on 300 dm ³ /40 °C/1 cycle
Thermal stress	100 °C/168 h
Power-frequency withstand voltage	1.39 kV

Shocks

Specification	IEC 60068-2-27:2008-02
Pulse shape	Semi-sinusoidal
Acceleration	30g
Shock duration	18 ms
Test directions	X-, Y- and Z-axis (pos. and neg.)

Ambient conditions

Ambient temperature (operation)	-40 °C ... 100 °C (dependent on the derating curve)
Ambient temperature (storage/transport)	-40 °C ... 70 °C
Relative humidity (storage/transport)	30 % ... 70 %
Ambient temperature (assembly)	-5 °C ... 100 °C

Packaging specifications

Type of packaging	packed in cardboard
-------------------	---------------------

Packaging specifications

DFK-MC 1,5/ 5-GF-3,81 - Feed-through header



1829374

<https://www.phoenixcontact.com/in/products/1829374>

Type of packaging	packed in cardboard
-------------------	---------------------

Drawings

Diagram

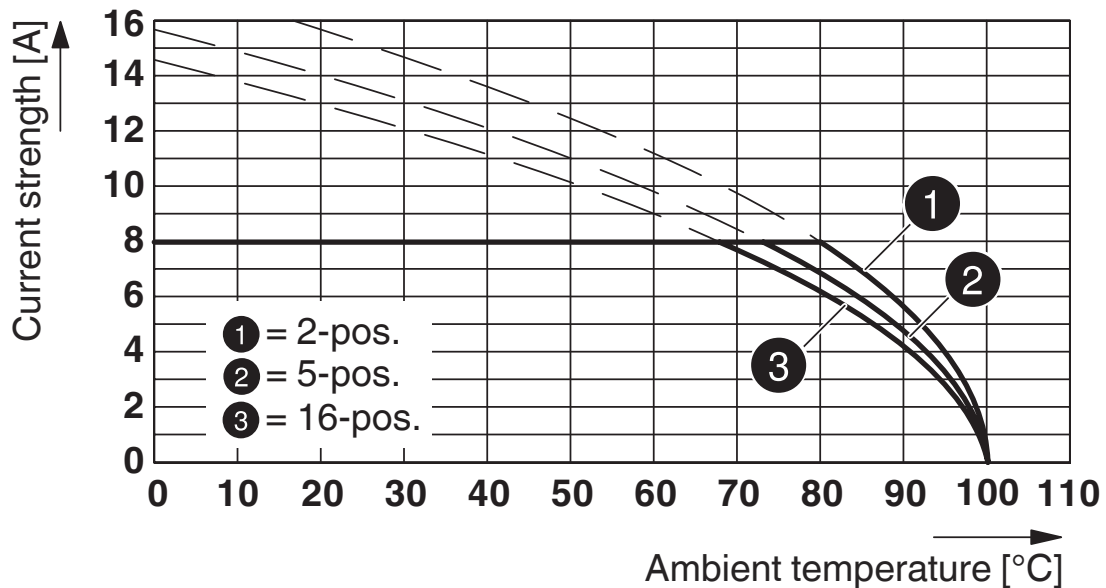

Type: MC 1,5/...-STF-3,81 with DFK-MC 1,5/...-GF-3,81 (with flat plug)

Diagram

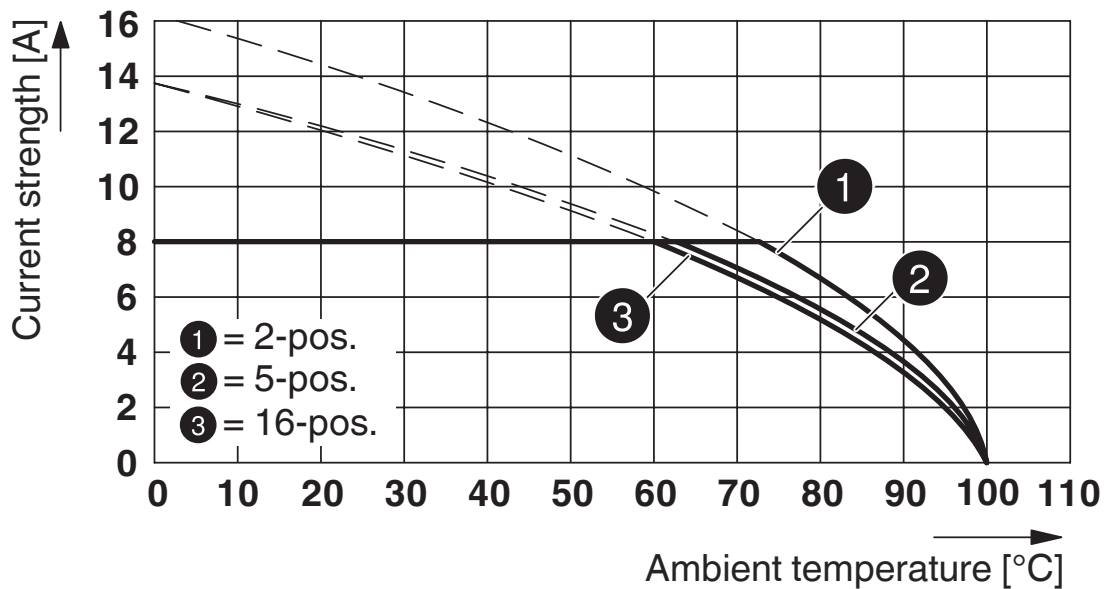

Type: FMC 1,5/...-STF-3,81 with DFK-MC 1,5/...-GF-3,81

DFK-MC 1,5/ 5-GF-3,81 - Feed-through header



1829374

<https://www.phoenixcontact.com/in/products/1829374>

Dimensional drawing

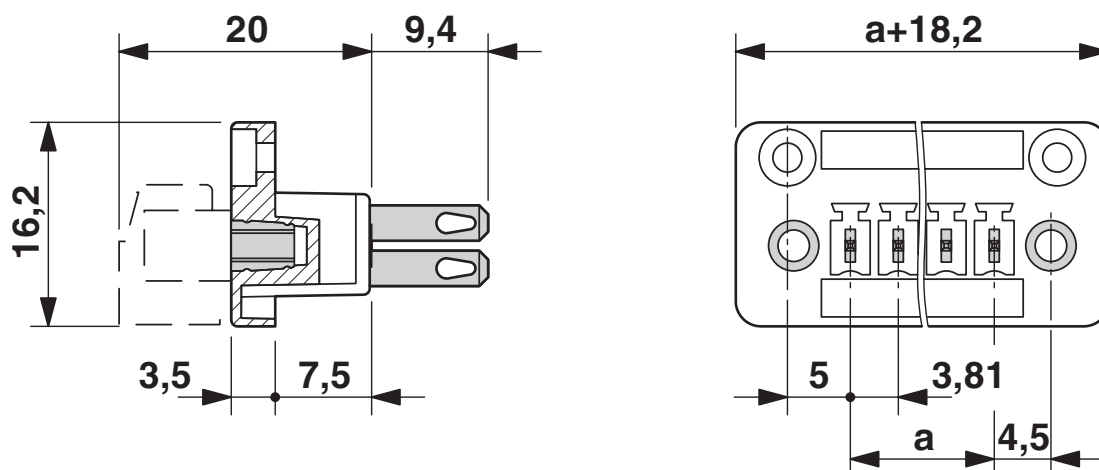

Diagram

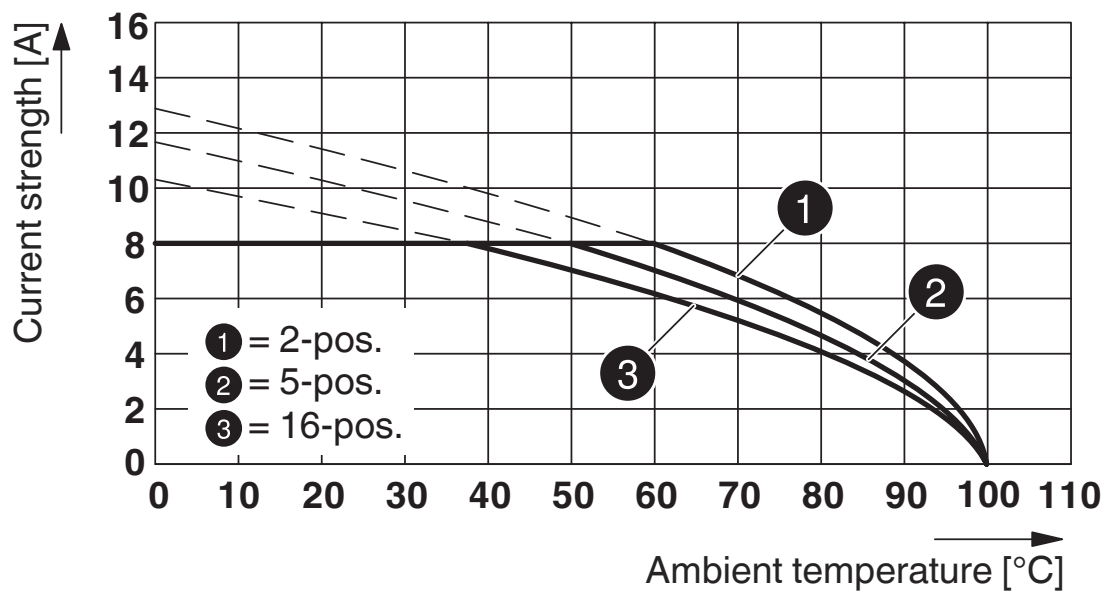

Type: MCVR 1,5/...-STF-3,81 with DFK-MC 1,5/...-GF-3,81

DFK-MC 1,5/ 5-GF-3,81 - Feed-through header



1829374

<https://www.phoenixcontact.com/in/products/1829374>

Drilling plan/solder pad geometry

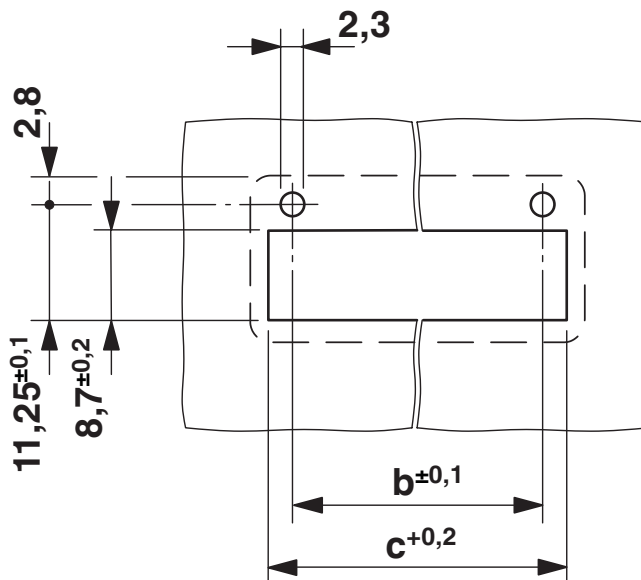

Dimension b: 6.19 mm + (no. of pos. x 3.81 mm)

Dimension c: Dim. b + 4.7 mm

Diagram

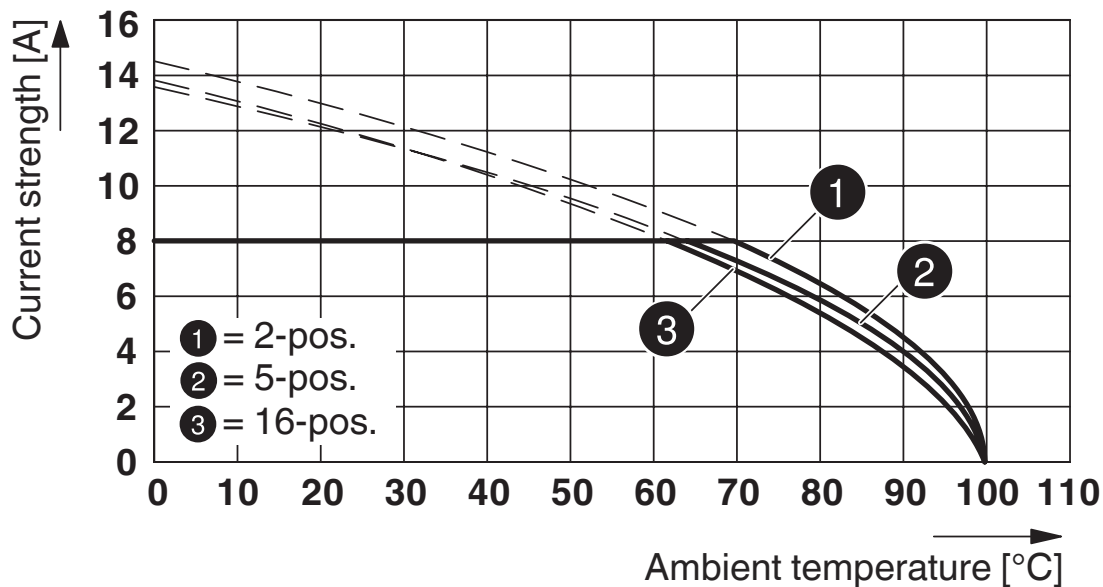

Type: FK-MCP 1,5/...-STF-3,81 with DFK-MC 1,5/...-GF-3,81

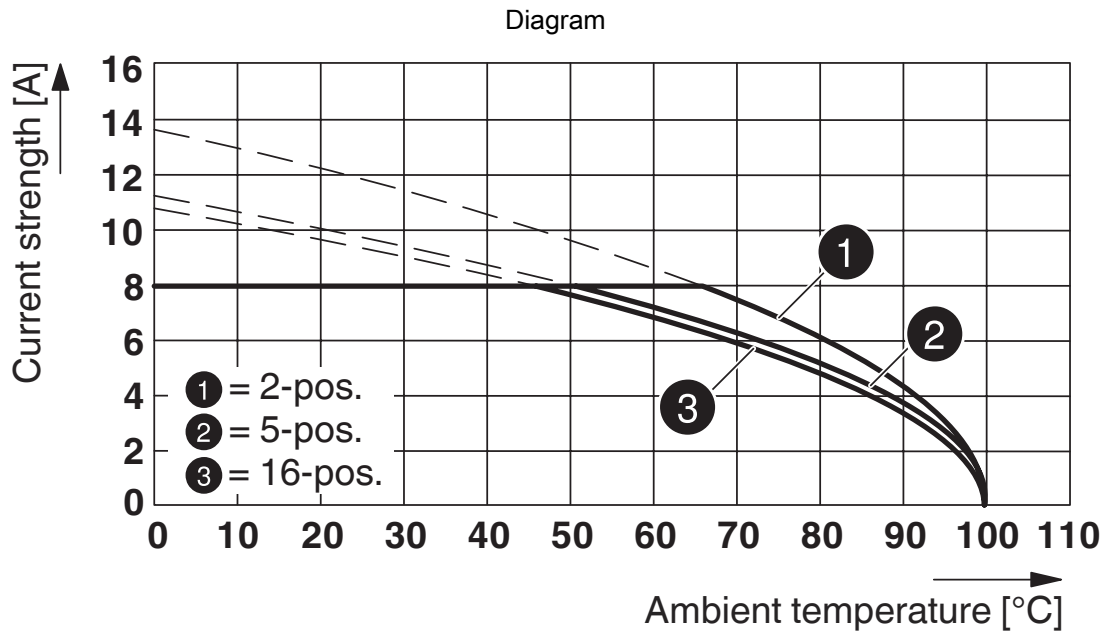

Type: FFRONT-MC 1,5/...-STF-3,81 with DFK-MC 1,5/...-GF-3,81

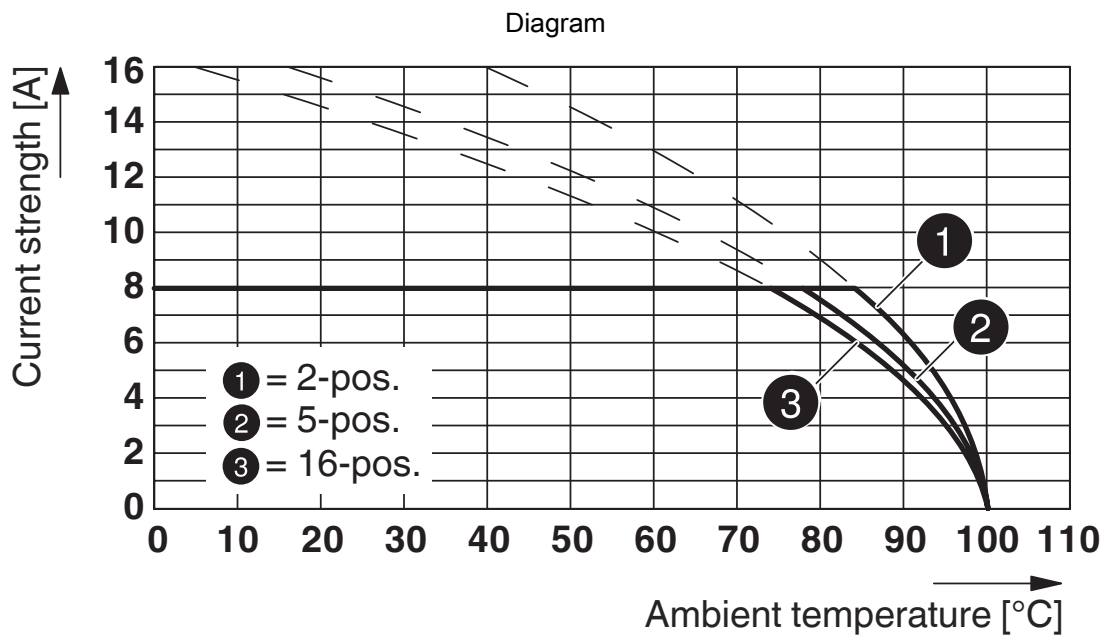

Type: MC 1,5/...-STF-3,81 with DFK-MC 1,5/...-GF-3,81 (with solder connection)

DFK-MC 1,5/ 5-GF-3,81 - Feed-through header





1829374

<https://www.phoenixcontact.com/in/products/1829374>

Approvals

 CSA Approval ID: 13631				
	Nominal Voltage U_N	Nominal Current I_N	Cross Section AWG	Cross Section mm^2
	150 V	8 A	-	-

 IECEE CB Scheme Approval ID: DE1-60987-B1B2				
	Nominal Voltage U_N	Nominal Current I_N	Cross Section AWG	Cross Section mm^2
	160 V	8 A	-	0.2 - 1.5

 EAC Approval ID: B.01687				
--	--	--	--	--

 cULus Recognized Approval ID: E60425-20110128				
	Nominal Voltage U_N	Nominal Current I_N	Cross Section AWG	Cross Section mm^2
	300 V	8 A	-	-
	300 V	8 A	-	-

 VDE Zeichengenehmigung Approval ID: 40011723				
	Nominal Voltage U_N	Nominal Current I_N	Cross Section AWG	Cross Section mm^2
	160 V	8 A	-	-

DFK-MC 1,5/ 5-GF-3,81 - Feed-through header



1829374

<https://www.phoenixcontact.com/in/products/1829374>

Classifications

ECLASS

ECLASS-11.0	27460201
ECLASS-12.0	27460201
ECLASS-13.0	27460201

ETIM

ETIM 8.0	EC002637
----------	----------

UNSPSC

UNSPSC 21.0	39121400
-------------	----------

DFK-MC 1,5/ 5-GF-3,81 - Feed-through header



1829374

<https://www.phoenixcontact.com/in/products/1829374>

Environmental Product Compliance

China RoHS	Environmentally friendly use period: unlimited = EFUP-e
	No hazardous substances above threshold values

DFK-MC 1,5/ 5-GF-3,81 - Feed-through header



1829374

<https://www.phoenixcontact.com/in/products/1829374>

Accessories

DFK-MC SS - Screw set

0710015

<https://www.phoenixcontact.com/in/products/0710015>



Screw set, for securing the header to the housing wall, consists of M2 x 8 screw, spring washer and nut, 1 piece each

CP-MSTB - Coding profile

1734634

<https://www.phoenixcontact.com/in/products/1734634>



Coding profile, is inserted into the slot on the plug or inverted header, red insulating material

DFK-MC 1,5/ 5-GF-3,81 - Feed-through header

1829374

<https://www.phoenixcontact.com/in/products/1829374>



SK 3,81/2,8:FORTL.ZAHLEN - Marker card

0804109

<https://www.phoenixcontact.com/in/products/0804109>

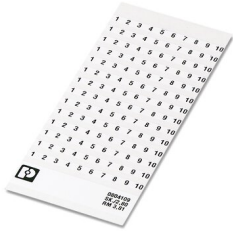

Marker card, white, labeled, horizontal: consecutive numbers 1 ... 10, 11 ... 20, etc. up to 91 ... (99)100, mounting type: adhesive, for terminal block width: 3.81 mm, lettering field size: 3.81 x 2.8 mm

SZS 0,4X2,5 VDE - Screwdriver

1205037

<https://www.phoenixcontact.com/in/products/1205037>



Screwdriver, slot-headed, VDE insulated, size: 0.4 x 2.5 x 80 mm, 2-component grip, with non-slip grip

DFK-MC 1,5/ 5-GF-3,81 - Feed-through header

1829374

<https://www.phoenixcontact.com/in/products/1829374>



C-SCF 1/2,8X0,8 - Connector

3240153

<https://www.phoenixcontact.com/in/products/3240153>



Slip-on sleeve, non-insulated, 0.5 ... 1 mm², 2.8 x 0.8

C-SCFI 1,5/2,8X0,8 - Connector

3240049

<https://www.phoenixcontact.com/in/products/3240049>



Slip-on sleeve, red, 0.5 ... 1.5 mm², 2.8 x 0.8

DFK-MC 1,5/ 5-GF-3,81 - Feed-through header

1829374

<https://www.phoenixcontact.com/in/products/1829374>

MCC 1/ 5-STZF-3,81 - PCB connector

1852396

<https://www.phoenixcontact.com/in/products/1852396>



PCB connector, nominal cross section: 1 mm², color: green, nominal current: 8 A, rated voltage (III/2): 160 V, type of contact: Socket, number of potentials: 5, number of rows: 1, number of positions: 5, number of connections: 5, product range: MCC 1/...-STZF, pitch: 3.81 mm, connection method: Crimp connection, conductor/PCB connection direction: 0 °, plug-in system: COMBICON MC 1,5, locking: Screw locking, mounting: Screw flange, type of packaging: packed in cardboard, Corresponding female crimp contacts with current [A] and conductor cross section range [mm²] data: 5A/MCC-MT 0,2-0,35 (1859988); 8A/MCC-MT 0,5-1,0 (1859991)

QC 0,5/ 5-STF-3,81 - Printed-circuit board connector

1897571

<https://www.phoenixcontact.com/in/products/1897571>

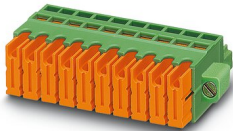

PCB connector, nominal cross section: 0.5 mm², color: green, nominal current: 6 A, rated voltage (III/2): 200 V, contact surface: Tin, type of contact: Socket, number of potentials: 5, number of rows: 1, number of positions: 5, number of connections: 5, product range: QC 0,5/...-STF, pitch: 3.81 mm, connection method: Displacement connection, conductor/PCB connection direction: 0 °, plug-in system: COMBICON MC 1,5, locking: Screw locking, mounting: Screw flange, type of packaging: packed in cardboard

DFK-MC 1,5/ 5-GF-3,81 - Feed-through header

1829374

<https://www.phoenixcontact.com/in/products/1829374>

FK-MCP 1,5/ 5-STF-3,81 - PCB connector

1851261

<https://www.phoenixcontact.com/in/products/1851261>

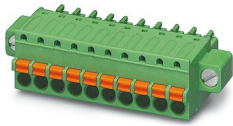

PCB connector, nominal cross section: 1.5 mm², color: green, nominal current: 8 A, rated voltage (III/2): 160 V, contact surface: Tin, type of contact: Socket, number of potentials: 5, number of rows: 1, number of positions: 5, number of connections: 5, product range: FK-MCP 1,5/..-STF, pitch: 3.81 mm, connection method: Push-in spring connection, conductor/PCB connection direction: 0 °, plug-in system: COMBICON MC 1,5, locking: Screw locking, mounting: Screw flange, type of packaging: packed in cardboard

FRONT-MC 1,5/ 5-STF-3,81 - Printed-circuit board connector

1850880

<https://www.phoenixcontact.com/in/products/1850880>

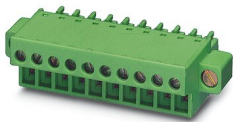

PCB connector, nominal cross section: 1.5 mm², color: green, nominal current: 8 A, rated voltage (III/2): 160 V, contact surface: Tin, type of contact: Socket, number of potentials: 5, number of rows: 1, number of positions: 5, number of connections: 5, product range: FRONT-MC 1,5/..-STF, pitch: 3.81 mm, connection method: Front screw connection, screw head form: L Slotted, conductor/PCB connection direction: 0 °, plug-in system: COMBICON MC 1,5, locking: Screw locking, mounting: Screw flange, type of packaging: packed in cardboard

DFK-MC 1,5/ 5-GF-3,81 - Feed-through header

1829374

<https://www.phoenixcontact.com/in/products/1829374>

MCVW 1,5/ 5-STF-3,81 - PCB connector

1828524

<https://www.phoenixcontact.com/in/products/1828524>

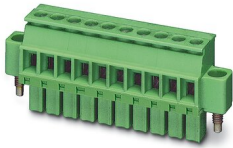

PCB connector, nominal cross section: 1.5 mm², color: green, nominal current: 8 A, rated voltage (III/2): 160 V, contact surface: Tin, type of contact: Socket, number of potentials: 5, number of rows: 1, number of positions: 5, number of connections: 5, product range: MCVW 1,5/...-STF, pitch: 3.81 mm, connection method: Screw connection with tension sleeve, screw head form: L Slotted, conductor/PCB connection direction: -90 °, plug-in system: COMBICON MC 1,5, locking: Screw locking, mounting: Screw flange, type of packaging: packed in cardboard

MC 1,5/ 5-STF-3,81 - PCB connector

1827732

<https://www.phoenixcontact.com/in/products/1827732>

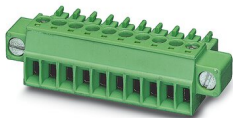

PCB connector, nominal cross section: 1.5 mm², color: green, nominal current: 8 A, rated voltage (III/2): 160 V, contact surface: Tin, type of contact: Socket, number of potentials: 5, number of rows: 1, number of positions: 5, number of connections: 5, product range: MC 1,5/...-STF, pitch: 3.81 mm, connection method: Screw connection with tension sleeve, screw head form: L Slotted, conductor/PCB connection direction: 0 °, plug-in system: COMBICON MC 1,5, locking: Screw locking, mounting: Screw flange, type of packaging: packed in cardboard

DFK-MC 1,5/ 5-GF-3,81 - Feed-through header



1829374

<https://www.phoenixcontact.com/in/products/1829374>

MCVR 1,5/ 5-STF-3,81 - PCB connector

1828375

<https://www.phoenixcontact.com/in/products/1828375>



PCB connector, nominal cross section: 1.5 mm², color: green, nominal current: 8 A, rated voltage (III/2): 160 V, contact surface: Tin, type of contact: Socket, number of potentials: 5, number of rows: 1, number of positions: 5, number of connections: 5, product range: MCVR 1,5/..-STF, pitch: 3.81 mm, connection method: Screw connection with tension sleeve, screw head form: L Slotted, conductor/PCB connection direction: 90 °, plug-in system: COMBICON MC 1,5, locking: Screw locking, mounting: Screw flange, type of packaging: packed in cardboard

Phoenix Contact 2023 © - all rights reserved

<https://www.phoenixcontact.com>

PHOENIX CONTACT (I) Pvt. Ltd.

A-58/2, Okhla Industrial Area, Phase - II, New Delhi-110 020

+91.1275.71420

info@phoenixcontact.co.in