

PLC-RSC- 12DC/21-21 - Relay Module



2967235

<https://www.phoenixcontact.com/in/products/2967235>

Please be informed that the data shown in this PDF document is generated from our Online Catalog. Please find the complete data in the user documentation. Our General Terms of Use for Downloads are valid.



PLC-INTERFACE, consisting of basic terminal block PLC-BSC.../21 with screw connection and plug-in miniature relay with power contact, for assembly on DIN rail NS 35/7,5, 2 changeover contacts, input voltage 12 V DC

Your advantages

- Slim design
- Efficient connection to system cabling using V8 adapter
- RT III sealed relay
- Safe isolation according to DIN EN 50178 between coil and contact
- Functional plug-in bridges
- Integrated input circuit and interference suppression circuit

Commercial Data

Item number	2967235
Packing unit	10 pc
Minimum order quantity	1 pc
Sales Key	CK6
Product Key	CK621C
Catalog Page	Page 366 (C-5-2019)
GTIN	4017918163501
Weight per Piece (including packing)	76.37 g
Weight per Piece (excluding packing)	68.08 g
Customs tariff number	85364190
Country of origin	IN

PLC-RSC- 12DC/21-21 - Relay Module

2967235

<https://www.phoenixcontact.com/in/products/2967235>

Set consists of

PLC-BSC- 12DC/21-21 - Relay base

2967251

<https://www.phoenixcontact.com/in/products/2967251>



14 mm PLC basic terminal block with screw connection, without relay or solid-state relay, for mounting on DIN rail NS 35/7,5, 2 changeover contacts, input voltage 12 V DC

REL-MR- 12DC/21-21 - Single relay

2961257

<https://www.phoenixcontact.com/in/products/2961257>



Plug-in miniature power relay, with power contact, 2 changeover contacts, input voltage 12 V DC

Technical Data

Product properties

Product type	Relay Module
Product family	PLC-INTERFACE
Application	Universal
Operating mode	100% operating factor
Mechanical service life	3x 10 ⁷ cycles

Insulation characteristics

Insulation	Safe isolation: Control side / contact side
------------	---

Insulation characteristics

Insulation	Safe isolation: Control side / contact side
Overvoltage category	III
Pollution degree	3

Electrical properties

Maximum power dissipation for nominal condition	0.4 W
Test voltage (Winding/contact)	4 kV AC (50 Hz, 1 min., winding/contact)
Test voltage (Changeover contact/changeover contact)	2.5 kV AC (50 Hz, 1 min., changeover contact/changeover contact)
Rated surge voltage	6 kV

Input data

Coil side

Nominal input voltage U_N	12 V DC
Input voltage range	10.3 V DC ... 16.8 V DC (20 °C)
Typical input current at U_N	33 mA
Typical response time	8 ms
Typical release time	10 ms
Protective circuit	Reverse polarity protection; Polarity protection diode Freewheeling diode; Freewheeling diode
Operating voltage display	Yellow LED

Output data

Switching

Contact type	2 changeover contacts
Type of switch contact	Single contact
Drive and function	monostable
Drive (polarity)	polarized
Contact material	AgNi
Maximum switching voltage	250 V AC/DC (The separating plate PLC-ATP should be installed for voltages larger than 250 V (L1, L2, L3) between identical

PLC-RSC- 12DC/21-21 - Relay Module



2967235

<https://www.phoenixcontact.com/in/products/2967235>

	terminal blocks in adjacent modules. Potential bridging is then carried out with FBST 8-PLC... or ...FBST 500...)
Minimum switching voltage	5 V AC/DC (10 mA)
Limiting continuous current	6 A
Maximum inrush current	15 A (300 ms)
Min. switching current	10 mA (5 V)
Interrupting rating (ohmic load) max.	140 W (at 24 V DC) 85 W (at 48 V DC) 60 W (at 60 V DC) 44 W (at 110 V DC) 60 W (at 220 V DC) 1500 VA (for 250 V AC)
Switching capacity	2 A (at 24 V, DC13) 3 A (at 24 V, AC15) 3 A (at 120 V, AC15) 0.2 A (at 250 V, DC13) 3 A (at 250 V, AC15)

Connection data

Connection method	Screw connection
Stripping length	8 mm
Screw thread	M3
Conductor cross section rigid	0.14 mm ² ... 2.5 mm ²
Conductor cross section flexible	0.14 mm ² ... 2.5 mm ² 0.2 mm ² ... 2.5 mm ² (Single ferrule) 2x 0.5 mm ² ... 1.5 mm ² (TWIN ferrule)
Conductor cross section AWG	26 ... 14
Tightening torque	0.6 Nm ... 0.8 Nm

Dimensions

Width	14 mm
Height	80 mm
Depth	94 mm

Material specifications

Flammability rating according to UL 94	V0 (Housing)
--	--------------

Environmental and real-life conditions

Ambient conditions

Degree of protection (Relay)	RT III (Relay)
Degree of protection (Relay base)	IP20 (Relay base)
Ambient temperature (operation)	-40 °C ... 60 °C
Ambient temperature (storage/transport)	-40 °C ... 85 °C

PLC-RSC- 12DC/21-21 - Relay Module



2967235

<https://www.phoenixcontact.com/in/products/2967235>

Approvals

Corrosive gas test

Identification	ISA-S71.04. G3 Harsh Group
	EN 60068-2-60

Standards and regulations

Standards/regulations	IEC 60947-5-1
-----------------------	---------------

Mounting

Mounting type	DIN rail mounting
Assembly instructions	in rows with zero spacing
Mounting position	any

Drawings

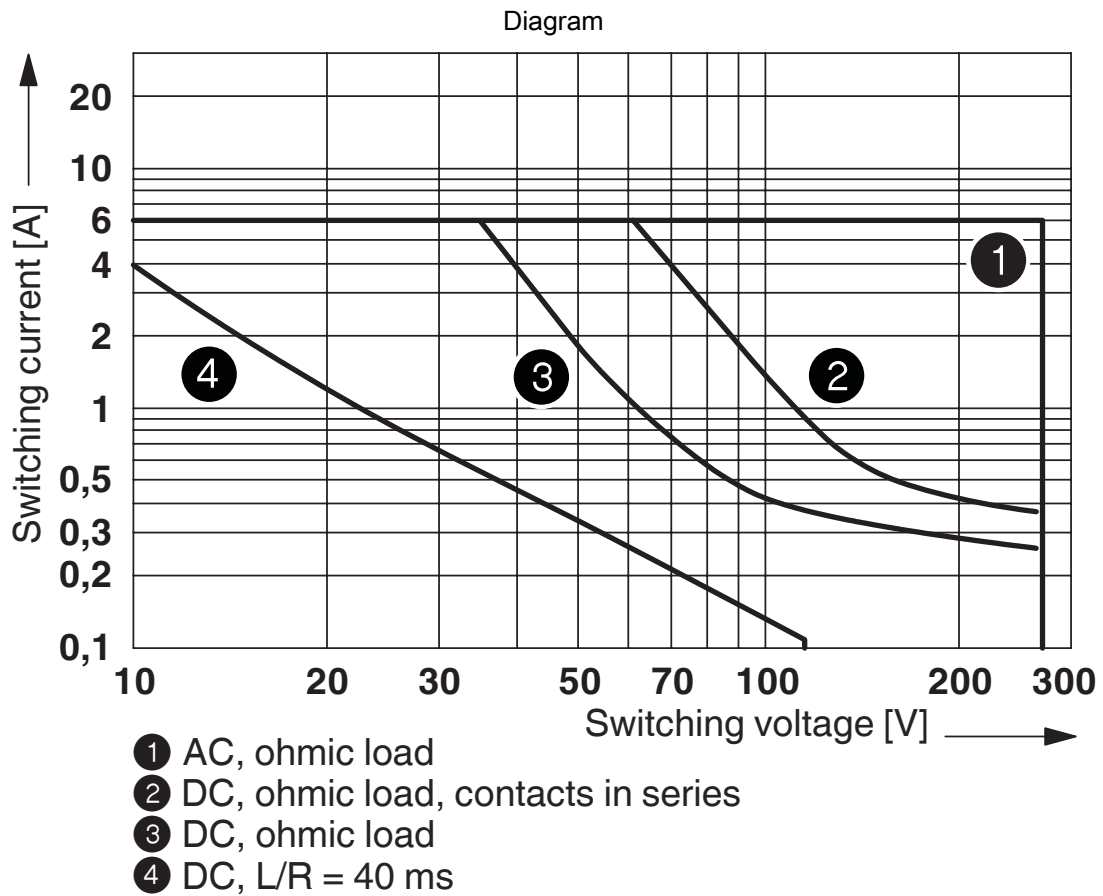

Interrupting rating

Diagram

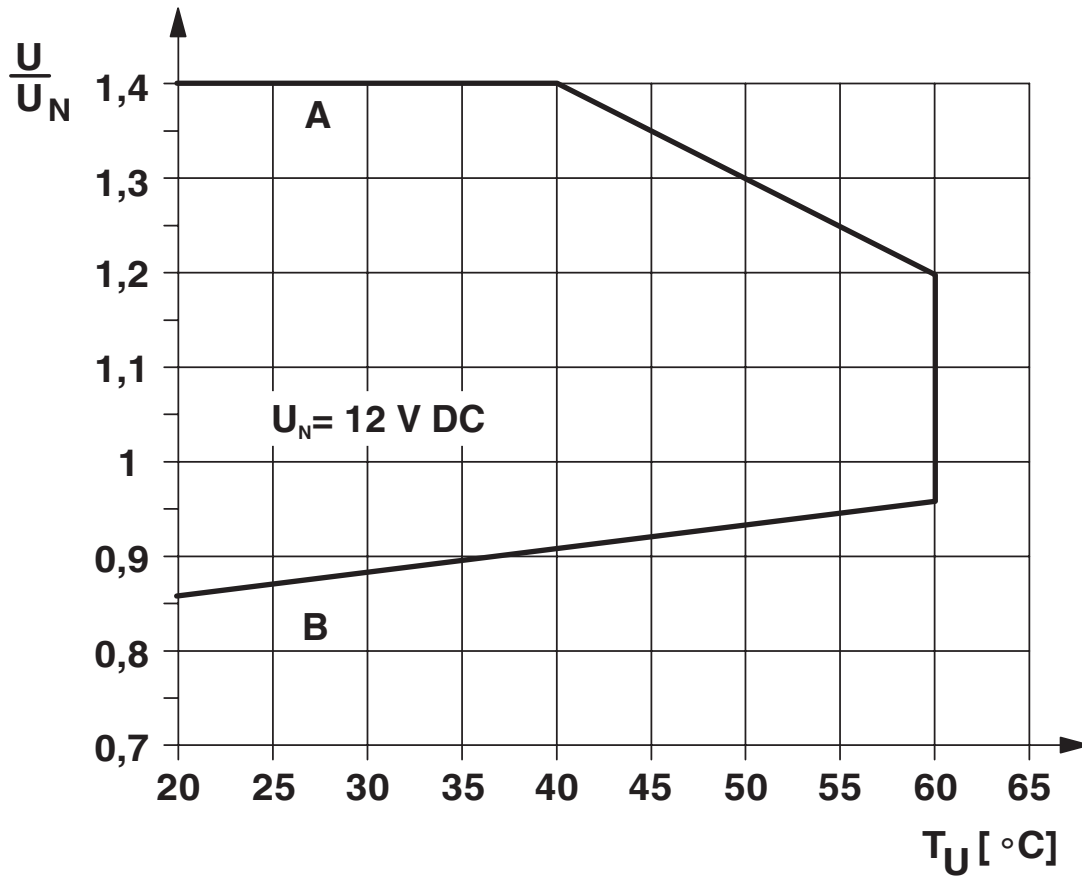

Curve A

Maximum permissible continuous voltage U_{max} with limiting continuous current on the contact side (see relevant technical data)

Curve B

Minimum permissible operate voltage U_{op} after pre-excitation (see relevant technical data)

PLC-RSC- 12DC/21-21 - Relay Module



2967235

<https://www.phoenixcontact.com/in/products/2967235>

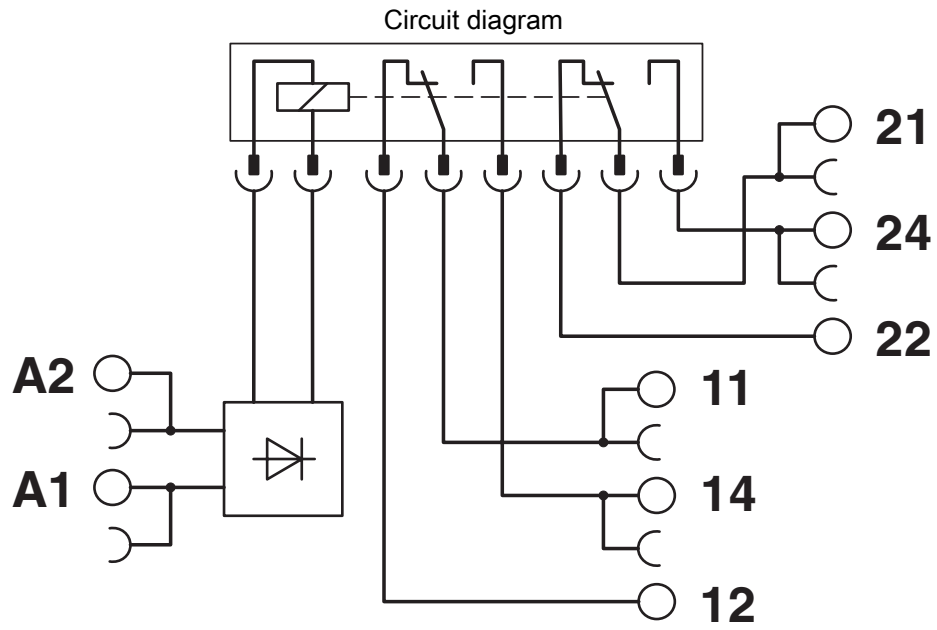

PLC-RSC- 12DC/21-21 - Relay Module



2967235

<https://www.phoenixcontact.com/in/products/2967235>

Approvals



cUL Recognized
Approval ID: FILE E 238705



UL Recognized
Approval ID: FILE E 238705



EAC
Approval ID: TR_TS_D_00573_c



DNV GL
Approval ID: TAE0000196



EAC
Approval ID: RU*C-DE.*08.B.00010



PRS
Approval ID: TE/2109/880590/16



UL Listed
Approval ID: FILE E 172140



cUL Listed
Approval ID: FILE E 172140



RC FRT
Approval ID: B.00094

PLC-RSC- 12DC/21-21 - Relay Module



2967235

<https://www.phoenixcontact.com/in/products/2967235>

Classifications

ECLASS

ECLASS-11.0	27371601
ECLASS-12.0	27371601
ECLASS-13.0	27371601

ETIM

ETIM 8.0	EC001437
----------	----------

UNSPSC

UNSPSC 21.0	39122300
-------------	----------

PLC-RSC- 12DC/21-21 - Relay Module



2967235

<https://www.phoenixcontact.com/in/products/2967235>

Environmental Product Compliance

REACH SVHC	Lead 7439-92-1
	Hexahydromethylphthalic anhydride
China RoHS	Environmentally Friendly Use Period = 50 years
	For information on hazardous substances, refer to the manufacturer's declaration available under "Downloads"

PLC-RSC- 12DC/21-21 - Relay Module

2967235

<https://www.phoenixcontact.com/in/products/2967235>

Accessories

 Note: Applying some accessories below might limit this product.

FBST 500-PLC RD - Continuous plug-in bridge

2966786

<https://www.phoenixcontact.com/in/products/2966786>



Continuous plug-in bridge, length: 500 mm, color: red

 Max. current carrying capacity: 32 A

FBST 500-PLC BU - Continuous plug-in bridge

2966692

<https://www.phoenixcontact.com/in/products/2966692>

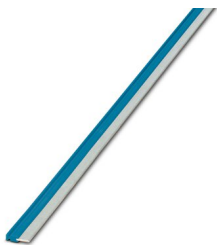

Continuous plug-in bridge, length: 500 mm, color: blue

 Max. current carrying capacity: 32 A

PLC-RSC- 12DC/21-21 - Relay Module

2967235

<https://www.phoenixcontact.com/in/products/2967235>



FBST 500-PLC GY - Continuous plug-in bridge

2966838

<https://www.phoenixcontact.com/in/products/2966838>



Continuous plug-in bridge, length: 500 mm, color: gray

 Max. current carrying capacity: 32 A

FBST 6-PLC RD - Single plug-in bridge

2966236

<https://www.phoenixcontact.com/in/products/2966236>

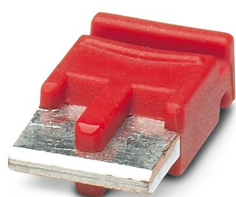

Single plug-in bridge, number of positions: 2, length: 6 mm, color: red

 Max. current carrying capacity: 6 A

PLC-RSC- 12DC/21-21 - Relay Module

2967235

<https://www.phoenixcontact.com/in/products/2967235>



FBST 6-PLC BU - Single plug-in bridge

2966812

<https://www.phoenixcontact.com/in/products/2966812>

Single plug-in bridge, number of positions: 2, length: 6 mm, color: blue



 Max. current carrying capacity: 6 A

FBST 6-PLC GY - Single plug-in bridge

2966825

<https://www.phoenixcontact.com/in/products/2966825>

Single plug-in bridge, number of positions: 2, length: 6 mm, color: gray



 Max. current carrying capacity: 6 A

PLC-RSC- 12DC/21-21 - Relay Module

2967235

<https://www.phoenixcontact.com/in/products/2967235>

FBST 8-PLC GY - Single plug-in bridge

2967688

<https://www.phoenixcontact.com/in/products/2967688>

Single plug-in bridge, number of positions: 2, length: 8 mm, color: gray



 Max. current carrying capacity: 6 A

FBST 14-PLC BK - Single plug-in bridge

2967691

<https://www.phoenixcontact.com/in/products/2967691>

Single plug-in bridge, number of positions: 2, length: 14 mm, color: black



 Max. current carrying capacity: 10 A

PLC-RSC- 12DC/21-21 - Relay Module



2967235

<https://www.phoenixcontact.com/in/products/2967235>

PLC-ATP BK - Separating plate

2966841

<https://www.phoenixcontact.com/in/products/2966841>



Separating plate, 2 mm thick, required at the start and end of a PLC terminal strip. Furthermore, it is used for: visual separation of groups, safe isolation of different voltages of neighboring PLC relays in acc. with DIN VDE 0106-101, isolation

PLC-ESK GY - Power terminal block

2966508

<https://www.phoenixcontact.com/in/products/2966508>



Power terminal block, for the input of up to four potentials, for mounting on NS 35/7.5

PLC-RSC- 12DC/21-21 - Relay Module



2967235

<https://www.phoenixcontact.com/in/products/2967235>

SZF 1-0,6X3,5 - Screwdriver

1204517

<https://www.phoenixcontact.com/in/products/1204517>



Actuation tool, for ST terminal blocks, also suitable for use as a bladed screwdriver, size: 0.6 x 3.5 x 100 mm, 2-component grip, with non-slip grip

ZB 10:UNBEDRUCKT - Zack marker strip

1053001

<https://www.phoenixcontact.com/in/products/1053001>



Zack marker strip, Strip, white, unlabeled, can be labeled with: PLOTMARK, CMS-P1-PLOTTER, mounting type: snapped, for terminal block width: 10.2 mm, lettering field size: 10.5 x 10.15 mm, Number of individual labels: 10

PLC-RSC- 12DC/21-21 - Relay Module

2967235

<https://www.phoenixcontact.com/in/products/2967235>

ZB 10 CUS - Zack marker strip

0824941

<https://www.phoenixcontact.com/in/products/0824941>



Zack marker strip, can be ordered: Strip, white, labeled according to customer specifications, mounting type: snap into tall marker groove, for terminal block width: 10.2 mm, lettering field size: 10,15 x 10,5 mm, Number of individual labels: 10

ZB10,LGS:FORTL.ZAHLEN - Zack marker strip

1053014

<https://www.phoenixcontact.com/in/products/1053014>



Zack marker strip, Strip, white, labeled, can be labeled with: CMS-P1-PLOTTER, printed horizontally: consecutive numbers 1 ... 10, 11 ... 20, etc. up to 91 ... 100, mounting type: snapped, for terminal block width: 10.2 mm, lettering field size: 10,15 x 10,5 mm, Number of individual labels: 10

PLC-RSC- 12DC/21-21 - Relay Module



2967235

<https://www.phoenixcontact.com/in/products/2967235>

ZB10,QR:FORTL.ZAHLEN - Zack marker strip

1053027

<https://www.phoenixcontact.com/in/products/1053027>



Zack marker strip, Strip, white, labeled, can be labeled with: CMS-P1-PLOTTER, Printed vertically: consecutive numbers 1 ... 10, 11 ... 20, etc. up to 91 ... 100, mounting type: snapped, for terminal block width: 10.2 mm, lettering field size: 10,15 x 10,5 mm, Number of individual labels: 10

ZB10,LGS:L1-N,PE - Marker for terminal blocks

1053412

<https://www.phoenixcontact.com/in/products/1053412>

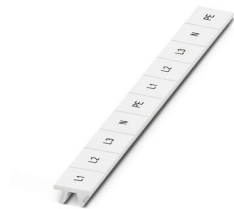

Marker for terminal blocks, Strip, white, labeled, can be labeled with: CMS-P1-PLOTTER, horizontal: L1, L2, L3, N, PE, L1, L2, L3, N, PE, mounting type: snapped, for terminal block width: 10.2 mm, lettering field size: 10,15 x 10,5 mm, Number of individual labels: 10

PLC-RSC- 12DC/21-21 - Relay Module

2967235

<https://www.phoenixcontact.com/in/products/2967235>



ZB10,LGS:U-N - Marker for terminal blocks

1053438

<https://www.phoenixcontact.com/in/products/1053438>



Marker for terminal blocks, Strip, white, labeled, can be labeled with: CMS-P1-PLOTTER, horizontal: U, V, W, N, GND, U, V, W, N, GND, mounting type: snapped, for terminal block width: 10.2 mm, lettering field size: 10,15 x 10,5 mm, Number of individual labels: 10

UC-TM 10 - Marker for terminal blocks

0818069

<https://www.phoenixcontact.com/in/products/0818069>



Marker for terminal blocks, Sheet, white, unlabeled, can be labeled with: BLUEMARK ID COLOR, BLUEMARK ID, BLUEMARK CLED, PLOTMARK, CMS-P1-PLOTTER, mounting type: snapped, for terminal block width: 10.2 mm, lettering field size: 9.6 x 10.5 mm, Number of individual labels: 48

PLC-RSC- 12DC/21-21 - Relay Module

2967235

<https://www.phoenixcontact.com/in/products/2967235>



UC-TM 10 CUS - Marker for terminal blocks

0824605

<https://www.phoenixcontact.com/in/products/0824605>



Marker for terminal blocks, can be ordered: by sheet, white, labeled according to customer specifications, mounting type: snap into tall marker groove, for terminal block width: 10.2 mm, lettering field size: 9.6 x 10.5 mm, Number of individual labels: 48

UCT-TM 10 - Marker for terminal blocks

0829142

<https://www.phoenixcontact.com/in/products/0829142>



Marker for terminal blocks, Sheet, white, unlabeled, can be labeled with: TOPMARK NEO, TOPMARK LASER, BLUEMARK ID COLOR, BLUEMARK ID, BLUEMARK CLED, THERMOMARK PRIME, THERMOMARK CARD 2.0, THERMOMARK CARD, mounting type: snapped, for terminal block width: 10.2 mm, lettering field size: 8.9 x 9.6 mm, Number of individual labels: 36

PLC-RSC- 12DC/21-21 - Relay Module



2967235

<https://www.phoenixcontact.com/in/products/2967235>

UCT-TM 10 CUS - Marker for terminal blocks

0829623

<https://www.phoenixcontact.com/in/products/0829623>



Marker for terminal blocks, can be ordered: by sheet, white, labeled according to customer specifications, mounting type: snap into tall marker groove, for terminal block width: 10.2 mm, lettering field size: 8.9 x 9.6 mm, Number of individual labels: 36

ZB 12:UNPRINTED - Zack marker strip

0812120

<https://www.phoenixcontact.com/in/products/0812120>

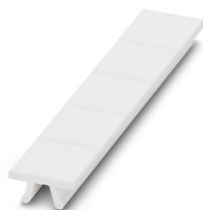

Zack marker strip, Strip, white, unlabeled, can be labeled with: PLOTMARK, CMS-P1-PLOTTER, mounting type: snapped, for terminal block width: 12.2 mm, lettering field size: 12 x 10.5 mm, Number of individual labels: 5

PLC-RSC- 12DC/21-21 - Relay Module

2967235

<https://www.phoenixcontact.com/in/products/2967235>

ZB 12 CUS - Zack marker strip

0824942

<https://www.phoenixcontact.com/in/products/0824942>

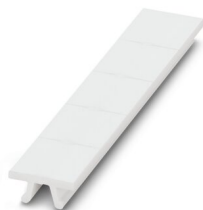

Zack marker strip, can be ordered: Strip, white, labeled according to customer specifications, mounting type: snap into tall marker groove, for terminal block width: 12.2 mm, lettering field size: 10.5 x 12.15 mm, Number of individual labels: 5

ZB 12,LGS:L1-N,PE - Zack marker strip

0812146

<https://www.phoenixcontact.com/in/products/0812146>



Zack marker strip, Strip, white, labeled, printed horizontally: L1, L2, L3, N, PE, mounting type: snapped, for terminal block width: 12.2 mm, lettering field size: 10.5 x 12.15 mm, Number of individual labels: 5

PLC-RSC- 12DC/21-21 - Relay Module

2967235

<https://www.phoenixcontact.com/in/products/2967235>

UC-TM 12 - Marker for terminal blocks

0819194

<https://www.phoenixcontact.com/in/products/0819194>



Marker for terminal blocks, Sheet, white, unlabeled, can be labeled with: BLUEMARK ID COLOR, BLUEMARK ID, BLUEMARK CLED, PLOTMARK, CMS-P1-PLOTTER, mounting type: snapped, for terminal block width: 12 mm, lettering field size: 11.45 x 10.5 mm, Number of individual labels: 40

UC-TM 12 CUS - Marker for terminal blocks

0824613

<https://www.phoenixcontact.com/in/products/0824613>



Marker for terminal blocks, can be ordered: by sheet, white, labeled according to customer specifications, mounting type: snap into tall marker groove, for terminal block width: 12 mm, lettering field size: 11.45 x 10.5 mm, Number of individual labels: 40

PLC-RSC- 12DC/21-21 - Relay Module

2967235

<https://www.phoenixcontact.com/in/products/2967235>

UCT-TM 12 - Marker for terminal blocks

0829144

<https://www.phoenixcontact.com/in/products/0829144>



Marker for terminal blocks, Sheet, white, unlabeled, can be labeled with: TOPMARK NEO, TOPMARK LASER, BLUEMARK ID COLOR, BLUEMARK ID, BLUEMARK CLED, THERMOMARK PRIME, THERMOMARK CARD 2.0, THERMOMARK CARD, mounting type: snapped, for terminal block width: 12 mm, lettering field size: 10.8 x 9.6 mm, Number of individual labels: 30

UCT-TM 12 CUS - Marker for terminal blocks

0829630

<https://www.phoenixcontact.com/in/products/0829630>



Marker for terminal blocks, can be ordered: by sheet, white, labeled according to customer specifications, mounting type: snap into tall marker groove, for terminal block width: 12 mm, lettering field size: 10.8 x 9.6 mm, Number of individual labels: 30

PLC-RSC- 12DC/21-21 - Relay Module

2967235

<https://www.phoenixcontact.com/in/products/2967235>

NS 35/ 7,5 PERF 2000MM - DIN rail perforated

0801733

<https://www.phoenixcontact.com/in/products/0801733>



DIN rail perforated, acc. to EN 60715, material: Steel, galvanized, passivated with a thick layer, Standard profile, color: silver, Pack of 25 (50 m)

NS 35/ 7,5 UNPERF 2000MM - DIN rail, unperforated

0801681

<https://www.phoenixcontact.com/in/products/0801681>



DIN rail, unperforated, acc. to EN 60715, material: Steel, galvanized, passivated with a thick layer, Standard profile, color: silver, Pack of 25 (50 m)

PLC-RSC- 12DC/21-21 - Relay Module

2967235

<https://www.phoenixcontact.com/in/products/2967235>



NS 35/ 7,5 WH PERF 2000MM - DIN rail perforated

1204119

<https://www.phoenixcontact.com/in/products/1204119>



DIN rail perforated, acc. to EN 60715, material: Steel, Galvanized, white passivated, Standard profile, color: silver, Pack of 25 (50 m)

NS 35/ 7,5 WH UNPERF 2000MM-VPE 10 - DIN rail, unperforated

1204122

<https://www.phoenixcontact.com/in/products/1204122>



DIN rail, unperforated, acc. to EN 60715, material: Steel, Galvanized, white passivated, Standard profile, color: silver, Pack of 10 (20 m)

PLC-RSC- 12DC/21-21 - Relay Module

2967235

<https://www.phoenixcontact.com/in/products/2967235>



NS 35/ 7,5 AL UNPERF 2000MM - DIN rail, unperforated

0801704

<https://www.phoenixcontact.com/in/products/0801704>



DIN rail, unperforated, acc. to EN 60715, material: Aluminum, uncoated, Standard profile, color: silver, Pack of 25 (50 m)

NS 35/ 7,5 ZN PERF 2000MM - DIN rail perforated

1206421

<https://www.phoenixcontact.com/in/products/1206421>



DIN rail perforated, acc. to EN 60715, material: Steel, galvanized, Standard profile, color: silver, Pack of 25 (50 m)

PLC-RSC- 12DC/21-21 - Relay Module

2967235

<https://www.phoenixcontact.com/in/products/2967235>



NS 35/ 7,5 ZN UNPERF 2000MM - DIN rail, unperforated

1206434

<https://www.phoenixcontact.com/in/products/1206434>



DIN rail, unperforated, acc. to EN 60715, material: Steel, galvanized, Standard profile, color: silver, Pack of 25 (50 m)

NS 35/ 7,5 CU UNPERF 2000MM-VPE 10 - DIN rail, unperforated

0801762

<https://www.phoenixcontact.com/in/products/0801762>



DIN rail, unperforated, acc. to EN 60715, material: Copper, uncoated, Standard profile, color: copper-colored, Pack of 10 (20 m)

PLC-RSC- 12DC/21-21 - Relay Module

2967235

<https://www.phoenixcontact.com/in/products/2967235>

NS 35/ 7,5 CAP - End cap

1206560

<https://www.phoenixcontact.com/in/products/1206560>

DIN rail end piece, for DIN rail NS 35/7.5



NS 35/15 PERF 2000MM - DIN rail perforated

1201730

<https://www.phoenixcontact.com/in/products/1201730>



DIN rail perforated, similar to EN 60715, material: Steel, galvanized, passivated with a thick layer, Standard profile, color: silver, Pack of 25 (50 m)

PLC-RSC- 12DC/21-21 - Relay Module



2967235

<https://www.phoenixcontact.com/in/products/2967235>

NS 35/15 UNPERF 2000MM - DIN rail, unperforated

1201714

<https://www.phoenixcontact.com/in/products/1201714>



DIN rail, unperforated, similar to EN 60715, material: Steel, galvanized, passivated with a thick layer, Standard profile, color: silver, Pack of 25 (50 m)

NS 35/15 WH PERF 2000MM - DIN rail perforated

0806602

<https://www.phoenixcontact.com/in/products/0806602>



DIN rail perforated, similar to EN 60715, material: Steel, Galvanized, white passivated, Standard profile, color: white, Pack of 25 (50 m)

PLC-RSC- 12DC/21-21 - Relay Module



2967235

<https://www.phoenixcontact.com/in/products/2967235>

NS 35/15 WH UNPERF 2000MM-VPE 10 - DIN rail, unperforated

1204135

<https://www.phoenixcontact.com/in/products/1204135>



DIN rail, unperforated, similar to EN 60715, material: Steel, Galvanized, white passivated, Standard profile, color: silver, Pack of 10 (20 m)

NS 35/15 AL UNPERF 2000MM - DIN rail, unperforated

1201756

<https://www.phoenixcontact.com/in/products/1201756>



DIN rail, unperforated, similar to EN 60715, material: Aluminum, uncoated, Standard profile, color: silver

PLC-RSC- 12DC/21-21 - Relay Module

2967235

<https://www.phoenixcontact.com/in/products/2967235>

NS 35/15 ZN PERF 2000MM - DIN rail perforated

1206599

<https://www.phoenixcontact.com/in/products/1206599>



DIN rail perforated, similar to EN 60715, material: Steel, galvanized, Standard profile, color: silver, Pack of 25 (50 m)

NS 35/15 ZN UNPERF 2000MM - DIN rail, unperforated

1206586

<https://www.phoenixcontact.com/in/products/1206586>



DIN rail, unperforated, similar to EN 60715, material: Steel, galvanized, Standard profile, color: silver, Pack of 25 (50 m)

PLC-RSC- 12DC/21-21 - Relay Module



2967235

<https://www.phoenixcontact.com/in/products/2967235>

NS 35/15 CU UNPERF 2000MM-VPE 10 - DIN rail, unperforated

1201895

<https://www.phoenixcontact.com/in/products/1201895>



DIN rail, unperforated, similar to EN 60715, material: Copper, uncoated, Standard profile, color: copper-colored, Pack of 10 (20 m)

NS 35/15 CAP - End cap

1206573

<https://www.phoenixcontact.com/in/products/1206573>

DIN rail end piece, for DIN rail NS 35/15



PLC-RSC- 12DC/21-21 - Relay Module

2967235

<https://www.phoenixcontact.com/in/products/2967235>



NS 35/15-2,3 UNPERF 2000MM-VPE 10 - DIN rail, unperforated

1201798

<https://www.phoenixcontact.com/in/products/1201798>



DIN rail, unperforated, acc. to EN 60715, material: Steel, galvanized, passivated with a thick layer, Standard profile 2.3 mm, color: silver, Pack of 10 (20 m)

PLC-BSC- 12DC/21-21 - Relay base

2967251

<https://www.phoenixcontact.com/in/products/2967251>



14 mm PLC basic terminal block with screw connection, without relay or solid-state relay, for mounting on DIN rail NS 35/7,5, 2 changeover contacts, input voltage 12 V DC

PLC-RSC- 12DC/21-21 - Relay Module

2967235

<https://www.phoenixcontact.com/in/products/2967235>



REL-MR- 12DC/21-21 - Single relay

2961257

<https://www.phoenixcontact.com/in/products/2961257>

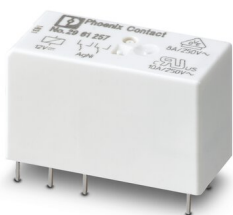

Plug-in miniature power relay, with power contact, 2 changeover contacts, input voltage 12 V DC

Phoenix Contact 2023 © - all rights reserved

<https://www.phoenixcontact.com>

PHOENIX CONTACT (I) Pvt. Ltd.

A-58/2, Okhla Industrial Area, Phase - II, New Delhi-110 020

+91.1275.71420

info@phoenixcontact.co.in