

Product datasheet

Specifications



Variable speed drive, Altivar Machine ATV340, 55 kW Heavy Duty, 400 V, 3 phases, Ethernet

ATV340D55N4E

Main

Range of product	Altivar Machine ATV340
Product or component type	Variable speed drive
Product specific application	Machine
Variant	Standard version
Mounting mode	Wall mount
Communication port protocol	EtherNet/IP Modbus TCP Modbus serial
Option card	Communication module, PROFINET Communication module, DeviceNet Communication module, CANopen Communication module, EtherCAT
Network number of phases	3 phases
Supply frequency	50...60 Hz +/- 5 %
[Us] rated supply voltage	380...480 V - 15...10 %
Nominal output current	106.0 A
Motor power kW	75 kW for normal duty 55 kW for heavy duty
Motor power hp	100 hp for normal duty 75 hp for heavy duty
EMC filter	Class C3 EMC filter integrated
IP degree of protection	IP20
Degree of protection	UL type 1

Complementary

Discrete input number	8
Discrete input type	PT1 safe torque off: 0...30 kHz, 24 V DC (30 V) DI1...DI5 programmable as pulse input, 24 V DC (30 V), impedance: 3.5 kOhm programmable
Number of preset speeds	16 preset speeds
Discrete output number	1.0
Discrete output type	Programmable output DQ1, DQ2 30 V DC 100 mA
Analogue input number	3
Analogue input type	AI1 software-configurable current: 0...20 mA, impedance: 250 Ohm, resolution 12 bits AI1 software-configurable temperature probe or water level sensor

AI1 software-configurable voltage: 0...10 V DC, impedance: 31.5 kOhm, resolution 12 bits
 AI2 software-configurable voltage: - 10...10 V DC, impedance: 31.5 kOhm, resolution 12 bits

Analogue output number	2
Analogue output type	Software-configurable voltage AQ1, AQ2: 0...10 V DC impedance 470 Ohm, resolution 10 bits Software-configurable current AQ1, AQ2: 0...20 mA impedance 500 Ohm, resolution 10 bits
Relay output number	3
Output voltage	<= power supply voltage
Relay output type	Relay outputs R1A Relay outputs R1C electrical durability 100000 cycles Relay outputs R2A Relay outputs R2C electrical durability 100000 cycles
Maximum switching current	Relay output R1C on resistive load, cos phi = 1: 3 A at 250 V AC Relay output R1C on resistive load, cos phi = 1: 3 A at 30 V DC Relay output R1C on inductive load, cos phi = 0.4 and L/R = 7 ms: 2 A at 250 V AC Relay output R1C on inductive load, cos phi = 0.4 and L/R = 7 ms: 2 A at 30 V DC Relay output R2C on resistive load, cos phi = 1: 5 A at 250 V AC Relay output R2C on resistive load, cos phi = 1: 5 A at 30 V DC Relay output R2C on inductive load, cos phi = 0.4 and L/R = 7 ms: 2 A at 250 V AC Relay output R2C on inductive load, cos phi = 0.4 and L/R = 7 ms: 2 A at 30 V DC
Minimum switching current	Relay output R1B: 5 mA at 24 V DC Relay output R2C: 5 mA at 24 V DC
Physical interface	2-wire RS 485
Connector type	3 RJ45
Method of access	Slave Modbus RTU Slave Modbus TCP
Transmission rate	4.8 kbit/s 9.6 kbit/s 19.2 kbit/s 38.4 kbit/s
Transmission frame	RTU
Number of addresses	1...247
Data format	8 bits, configurable odd, even or no parity
Type of polarization	No impedance
4 quadrant operation possible	True
Asynchronous motor control profile	Variable torque standard Optimized torque mode Constant torque standard
Synchronous motor control profile	Reluctance motor Permanent magnet motor
Pollution degree	2 conforming to EN/IEC 61800-5-1
Maximum output frequency	0.599 kHz
Acceleration and deceleration ramps	Linear adjustable separately from 0.01...9999 s S, U or customized
Motor slip compensation	Not available in permanent magnet motor law Automatic whatever the load Can be suppressed Adjustable
Switching frequency	1...8 kHz adjustable 2.5...8 kHz with derating factor
Nominal switching frequency	2.5 kHz
Braking to standstill	By DC injection
Brake chopper integrated	True
Line current	131.3 A at 380 V (normal duty) 112.7 A at 480 V (normal duty) 98.9 A at 380 V (heavy duty) 86.9 A at 480 V (heavy duty) 131.3 A at 380 V with internal line choke (normal duty) 112.7 A at 480 V with internal line choke (normal duty) 98.9 A at 380 V with internal line choke (heavy duty) 86.9 A at 480 V with internal line choke (heavy duty) 98.9 A

	86.9 A
Maximum input current	131.3 A
Maximum output voltage	480 V
Apparent power	93.7 kVA at 480 V (normal duty) 72.2 kVA at 480 V (heavy duty)
Maximum transient current	174 A during 60 s (normal duty) 159 A during 60 s (heavy duty) 174 A during 2 s (normal duty) 159 A during 2 s (heavy duty)
Electrical connection	Screw terminal, clamping capacity: 0.75...1.5 mm ² for control Screw terminal, clamping capacity: 70...120 mm ² for DC bus Screw terminal, clamping capacity: 95...120 mm ² for line side Screw terminal, clamping capacity: 95...120 mm ² for motor
Prospective line I_{sc}	50 kA
Base load current at high overload	106.0 A
Base load current at low overload	145.0 A
Power dissipation in W	Natural convection: 115 W at 380 V, switching frequency 4 kHz (heavy duty) Forced convection: 917 W at 380 V, switching frequency 4 kHz (heavy duty) Natural convection: 158 W at 380 V, switching frequency 4 kHz (normal duty) Forced convection: 1359 W at 380 V, switching frequency 4 kHz (normal duty) Control: screw terminal 0.75...1.5 mm ² /AWG 18...AWG 16 DC bus: screw terminal 70...120 mm ² /AWG 1/0...250 kcmil Line side: screw terminal 95...120 mm ² /AWG 3/0...250 kcmil Motor: screw terminal 95...120 mm ² /AWG 3/0...250 kcmil
With safety function Safely Limited Speed (SLS)	True
With safety function Safe brake management (SBC/SBT)	True
With safety function Safe Operating Stop (SOS)	False
With safety function Safe Position (SP)	False
With safety function Safe programmable logic	False
With safety function Safe Speed Monitor (SSM)	False
With safety function Safe Stop 1 (SS1)	True
With sft fct Safe Stop 2 (SS2)	False
With safety function Safe torque off (STO)	True
With safety function Safely Limited Position (SLP)	False
With safety function Safe Direction (SDI)	False
Protection type	Thermal protection: motor Safe torque off: motor Motor phase loss: motor Thermal protection: drive Safe torque off: drive Overheating: drive Overcurrent: drive Output overcurrent between motor phase and earth: drive Output overcurrent between motor phases: drive Short-circuit between motor phase and earth: drive Short-circuit between motor phases: drive Motor phase loss: drive DC Bus overvoltage: drive Line supply overvoltage: drive Line supply undervoltage: drive Input supply loss: drive Exceeding limit speed: drive Break on the control circuit: drive

Width	271.0 mm
Height	908.0 mm
Depth	309.0 mm
Net weight	57.9 kg
Continuous output current	145 A at 4 kHz for normal duty 106 A at 4 kHz for heavy duty

Environment

Operating altitude	<= 4800 m with current derating above 1000m
Operating position	Vertical +/- 10 degree
Product certifications	UL CSA TÜV EAC CTick
Marking	CE
Standards	EN/IEC 61800-3 EN/IEC 61800-5-1 IEC 60721-3 IEC 61508 IEC 13849-1 UL 618000-5-1 UL 508C IEC 61000-3-12
Maximum THDI	<48 % full load conforming to IEC 61000-3-12 <48 % 80 % load conforming to IEC 61000-3-12
Assembly style	With heat sink
Electromagnetic compatibility	Electrostatic discharge immunity test level 3 conforming to IEC 61000-4-2 Radiated radio-frequency electromagnetic field immunity test level 3 conforming to IEC 61000-4-3 Electrical fast transient/burst immunity test level 4 conforming to IEC 61000-4-4 1.2/50 µs - 8/20 µs surge immunity test level 3 conforming to IEC 61000-4-5 Conducted radio-frequency immunity test level 3 conforming to IEC 61000-4-6
Environmental class (during operation)	Class 3C3 according to IEC 60721-3-3 Class 3S3 according to IEC 60721-3-3
Maximum acceleration under shock impact (during operation)	150 m/s ² at 11 ms
Maximum acceleration under vibrational stress (during operation)	10 m/s ² at 13...200 Hz
Maximum deflection under vibratory load (during operation)	1.5 mm at 2...13 Hz
Permitted relative humidity (during operation)	Class 3K5 according to EN 60721-3
Volume of cooling air	295.0 m ³ /h
Type of cooling	Forced convection
Overvoltage category	Class III
Regulation loop	Adjustable PID regulator
Noise level	62.4 dB 2
Ambient air transport temperature	-40...70 °C
Ambient air temperature for operation	-15...50 °C without derating (vertical position) 50...60 °C with derating factor (vertical position)
Ambient air temperature for storage	-40...70 °C
Isolation	Between power and control terminals

Packing Units

Unit Type of Package 1	PCE
Number of Units in Package 1	1
Package 1 Height	60 cm
Package 1 Width	43 cm
Package 1 Length	111 cm
Package 1 Weight	59 kg

Offer Sustainability

Sustainable offer status	Green Premium product
REACH Regulation	REACH Declaration
EU RoHS Directive	Pro-active compliance (Product out of EU RoHS legal scope) EU RoHS Declaration
Mercury free	Yes
China RoHS Regulation	China RoHS declaration
RoHS exemption information	Yes
Environmental Disclosure	Product Environmental Profile
Circularity Profile	End of Life Information
WEEE	The product must be disposed on European Union markets following specific waste collection and never end up in rubbish bins
Upgradeability	Upgraded components available

Dimensions

Views: Front - Left - Rear

mm
in

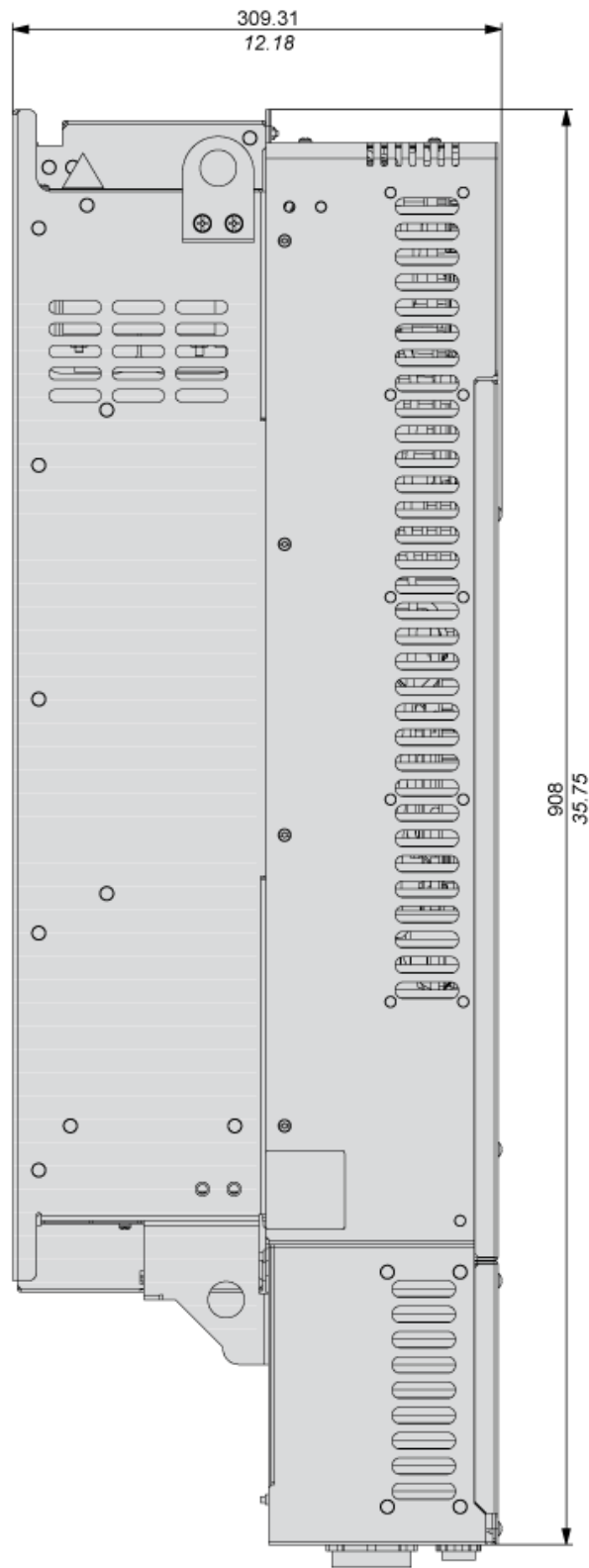
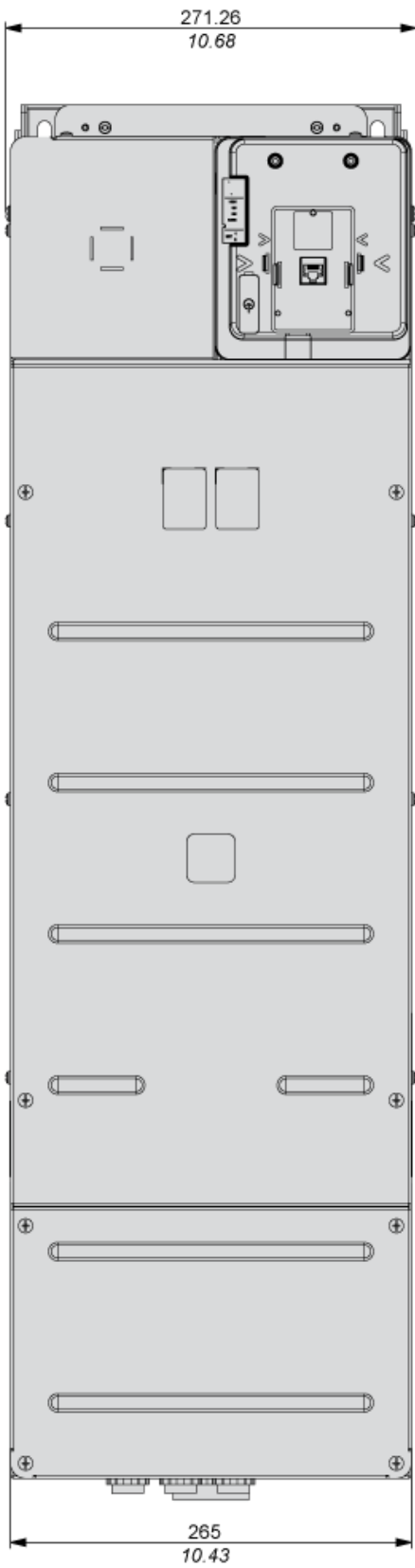

Clearance

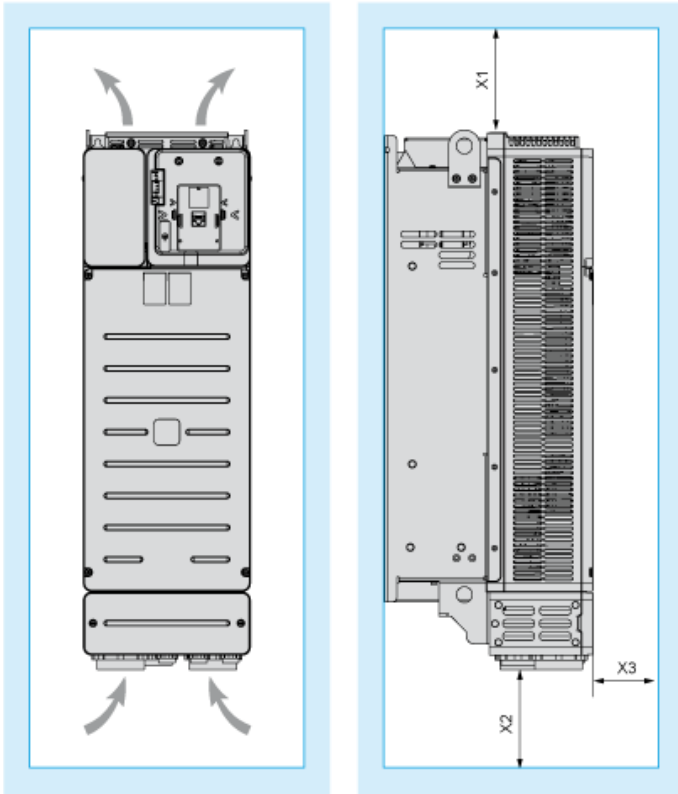

Dimensions in mm

X1	X2	X3
≥ 100	≥ 100	≥ 10

Dimensions in in.

X1	X2	X3
≥ 3.94	≥ 3.94	≥ 0.39

Mounting Types

Mounting Type A: Side by Side IP20

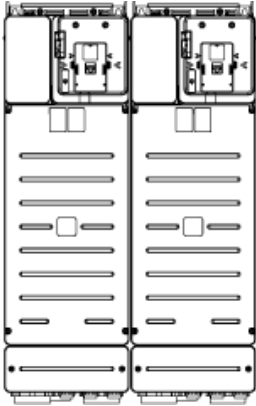

Possible, up to 50 °C, 2 drives only

Mounting Type B: Individual IP20

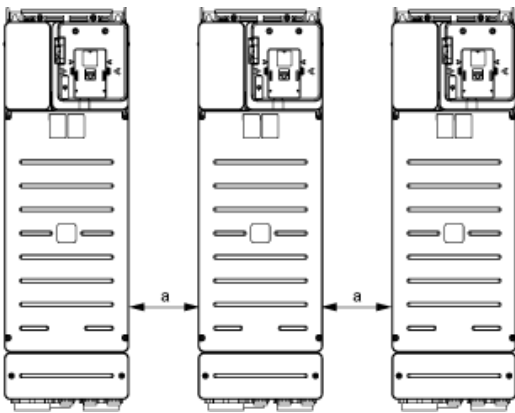

a \geq 110 mm (4.33 in.)

Connections and Schema

Three-Phase Power Supply with Upstream Breaking via Line Contactor Without Safety Function STO

Connection diagrams conforming to standards ISO13849 category 1 and IEC/EN 61508 capacitySIL1, stopping category 0 in accordance with standard IEC/EN 60204-1.

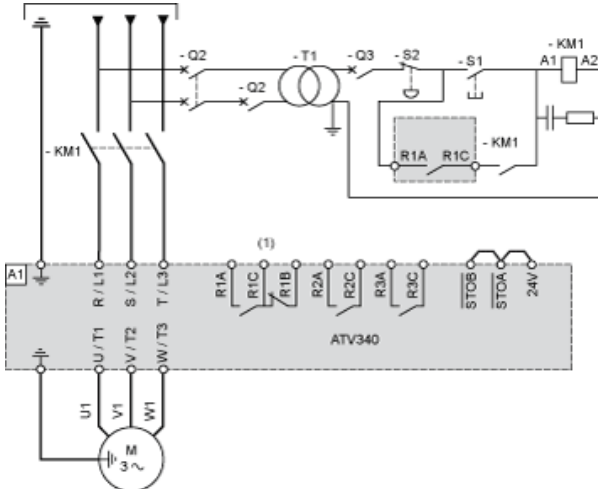

- (1) Use relay output R1 set to operating state Fault to switch Off the product once an error is detected.
- A1 : Drive
- KM1 : Line Contactor
- Q2, Q3 : Circuit breakers
- S1 : Pushbutton
- S2 : Emergency stop
- T1 : Transformer for control part

Three-Phase Power Supply with Downstream Breaking via Switch Disconnecter

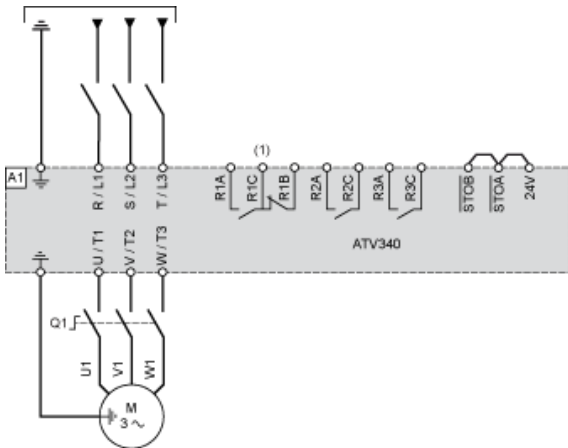

- (1) Use relay output R1 set to operating state Fault to switch Off the product once an error is detected.
- A1 : Drive
- Q1 : Switch disconnector

Sensor Connection

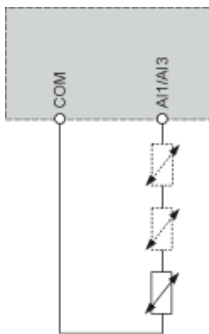

It is possible to connect either 1 or 3 sensors on terminals A1/AI3.

Control Block Wiring Diagram

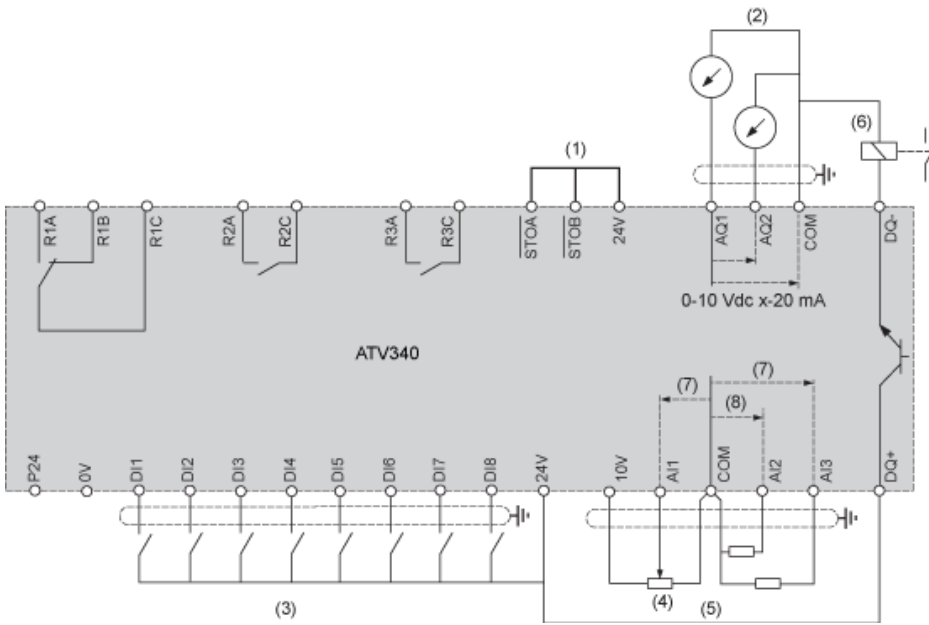

- (1) Safe Torque Off
 - (2) Analog Output
 - (3) Digital Input
 - (4) Reference potentiometer
 - (5) Analog Input
 - (6) Digital Output
 - (7) 0-10 Vdc, x-20 mA
 - (8) 0-10 Vdc, -10 Vdc...+10 Vdc
- A1 : ATV340 Drive
R1A, R1B, R1C : Relay
R2A, R2C : Sequence relay
R3A, R3C : Sequence relay

Digital Inputs Wiring

Switch Set to SRC (Source) Position Using the Output Power Supply for the Digital Inputs

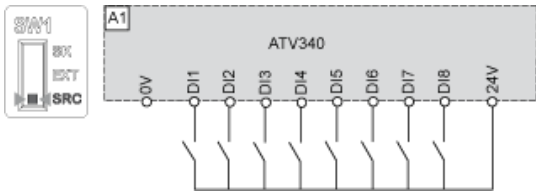

Switch Set to SRC (Source) Position and Use of an External Power Supply for the DIs

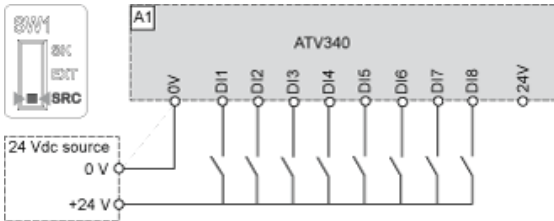

Switch Set to SK (Sink) Position Using the Output Power Supply for the Digital Inputs

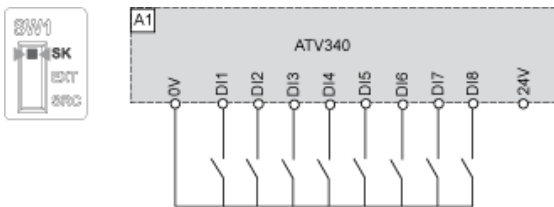

Switch Set to EXT Position Using an External Power Supply for the DIs

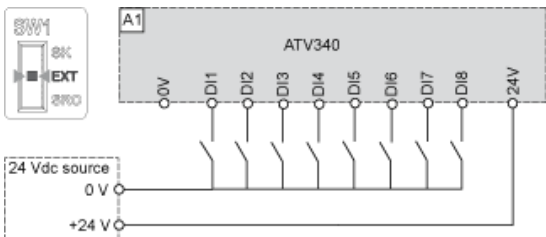

Digital Outputs Wiring

Digital Outputs: Internal Supply

Positive Logic, Source, European Style, DQ switches to +24V



(1) Relay or valve

Negative Logic, Sink, Asian Style, DQ switches to 0V

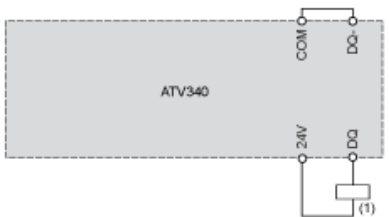

(1) Relay or valve

Digital Outputs: External Supply

Positive Logic, Source, European Style, DQ switches to +24V

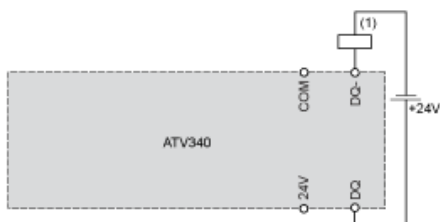

(1) Relay or valve

Negative Logic, Sink, Asian Style, DQ switches to 0V

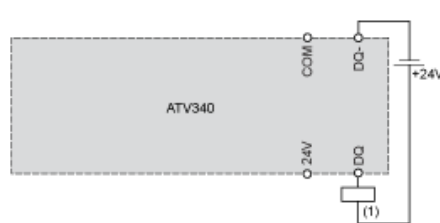

(1) Relay or valve

Open Loop Applications

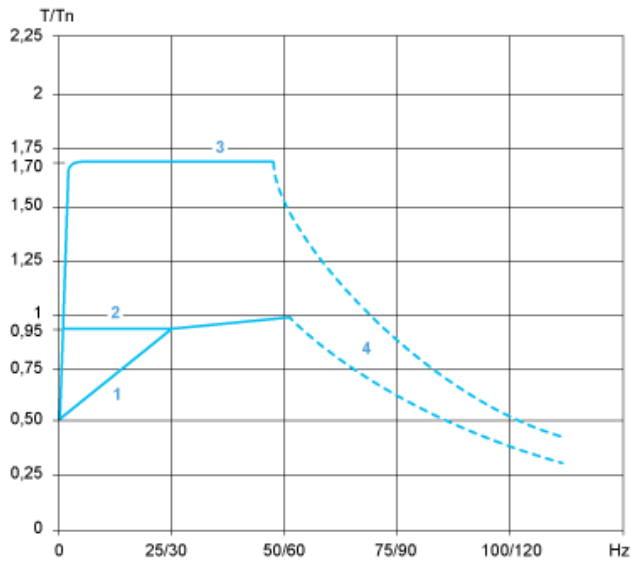

- 1 : Self-cooled motor: continuous useful torque
- 2 : Force-cooled motor: continuous useful torque
- 3 : Overtorque for 60 s maximum
- 4 : Torque in overspeed at constant power

Closed Loop Applications

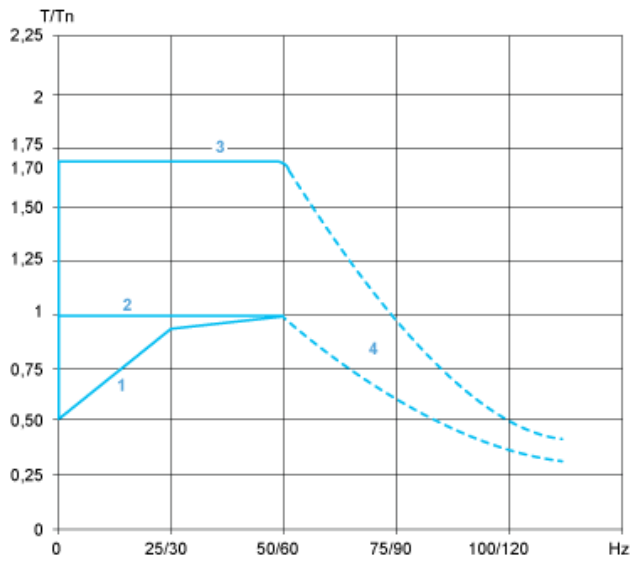

- 1 : Self-cooled motor: continuous useful torque
- 2 : Force-cooled motor: continuous useful torque
- 3 : Overtorque for 60 s maximum
- 4 : Torque in overspeed at constant power

Recommended replacement(s)