

Product data sheet

Specifications



Remote receiver module, Modicon TM3,

TM3XREC1

Main

Range of product	Modicon TM3
Product or component type	Remote receiver module
Range compatibility	Modicon M221 Modicon M251 Modicon M241 Modicon M262
[Us] rated supply voltage	24 V DC by external supply (- 15...20 %)

Complementary

Maximum number of I/O expansion module	7
Power supply output current	560 mA 5 V for expansion bus 560 mA 24 V for expansion bus
Current consumption	40 mA at 24 V DC via bus connector
Maximum power dissipation in W	1 W
Cable distance between devices	0.5...5 mm extension cable with 2 RJ45 conductor between receiver and transmitter
Local signalling	1 LED (green) for power supply 1 LED (green) for link status
Electrical connection	RJ45 connector for connecting the bus transmitter removable screw terminal block, 3 terminal(s) for connecting the 24 V DC power supply
Marking	CE
Resistance to electrostatic discharge	8 kV in air conforming to EN/IEC 61000-4-2 6 kV on contact conforming to EN/IEC 61000-4-2
Resistance to electromagnetic fields	10 V/m 80 MHz...1 GHz conforming to EN/IEC 61000-4-3 3 V/m 1.4 GHz...2 GHz conforming to EN/IEC 61000-4-3 1 V/m 2...2.7 GHz conforming to EN/IEC 61000-4-3
Resistance to conducted disturbances	10 V 0.15...80 MHz conforming to EN/IEC 61000-4-6 3 V spot frequency (2, 3, 4, 6.2, 8.2, 12.6, 16.5, 18.8, 22, 25 MHz) conforming to Marine specification (LR, ABS, DNV, GL)
Electromagnetic emission	Radiated emissions - test level: 40 dB μ V/m QP class A (10 m) at 30...230 MHz conforming to EN/IEC 55011 Radiated emissions - test level: 47 dB μ V/m QP class A (10 m) at 230...1000 MHz conforming to EN/IEC 55011
Mounting support	Top hat type TH35-15 rail conforming to IEC 60715 Top hat type TH35-7.5 rail conforming to IEC 60715 plate or panel with fixing kit
Height	90 mm

Depth	73.3 mm
Width	23.65 mm
Net weight	0.075 kg

Environment

Standards	Class I Division 2 Groups A/B/C/D CSA C22.2 No 213 Class I Division 2 Groups A/B/C UL 1604 CSA C22.2 No 142 IEC 61131-2 UL 508
Product certifications	Merchant Navy GOST C-Tick CSA HazLoc CE UKCA RCM EAC cULus
Ambient air temperature for operation	-10...55 °C (horizontal installation) -10...50 °C (vertical installation)
Ambient air temperature for storage	-40...70 °C
Relative humidity	5...95 % without condensation
IP degree of protection	IP20 with protective cover in place
Pollution degree	2
Operating altitude	0...2000 m
Storage altitude	0...3000 m
Vibration resistance	3.5 mm at 5...8.4 Hz on DIN rail 3 gn at 8.4...150 Hz on DIN rail 3.5 mm at 5...8.4 Hz on panel 3 gn at 8.4...150 Hz on panel
Shock resistance	15 gn for 11 ms

Packing Units

Unit Type of Package 1	PCE
Number of Units in Package 1	1
Package 1 Height	7.414 cm
Package 1 Width	10.483 cm
Package 1 Length	12.587 cm
Package 1 Weight	160.0 g
Unit Type of Package 2	S03
Number of Units in Package 2	18
Package 2 Height	30 cm
Package 2 Width	30 cm
Package 2 Length	40 cm
Package 2 Weight	3.631 kg
Unit Type of Package 3	P12
Number of Units in Package 3	144
Package 3 Height	75 cm
Package 3 Width	60 cm
Package 3 Length	80 cm

Package 3 Weight	40 kg
------------------	-------

Offer Sustainability

Sustainable offer status	Green Premium product
REACH Regulation	REACH Declaration
EU RoHS Directive	Pro-active compliance (Product out of EU RoHS legal scope) EU RoHS Declaration
Mercury free	Yes
China RoHS Regulation	China RoHS declaration
RoHS exemption information	Yes
Environmental Disclosure	Product Environmental Profile
Circularity Profile	End of Life Information
WEEE	The product must be disposed on European Union markets following specific waste collection and never end up in rubbish bins
PVC free	Yes
California proposition 65	WARNING: This product can expose you to chemicals including: Lead and lead compounds, which is known to the State of California to cause cancer and birth defects or other reproductive harm. For more information go to www.P65Warnings.ca.gov

Dimensions

mm
in.

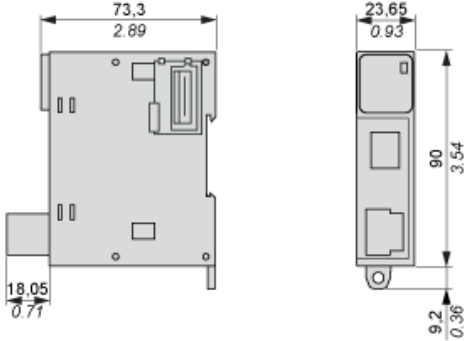

Spacing Requirements

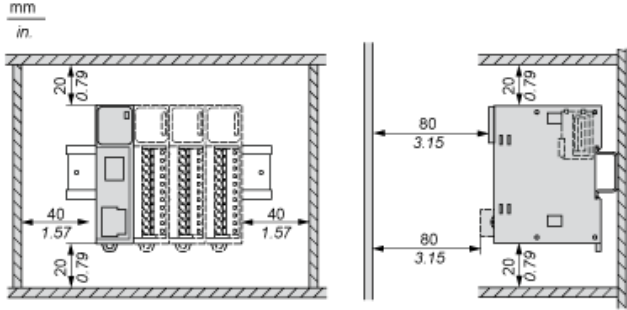

Mounting on a Rail

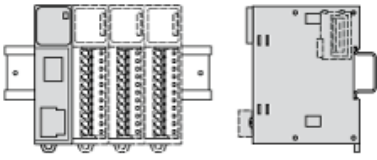

Vertical Mounting

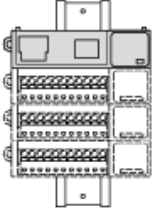

Incorrect Mounting

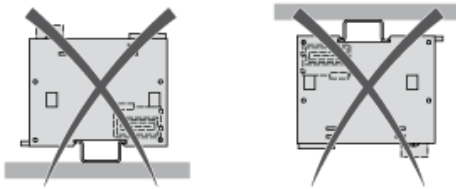

Mounting on a Panel Surface

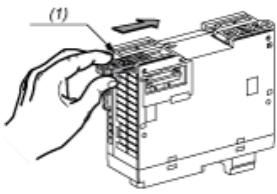

(1) Install a mounting strip

Mounting Hole Layout

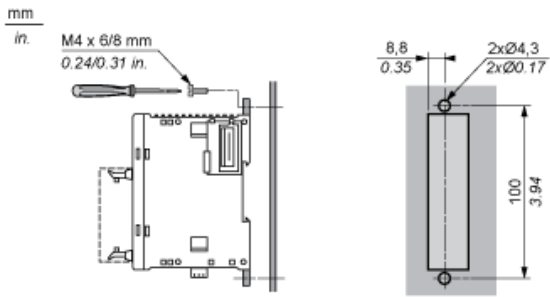

Recommended replacement(s)