

# Product data sheet

Specifications



Modular timing relay, Harmony, 0.7A, 1CO, 0,1s..100h, on delay, solid state output, 24..240V AC DC

RE17LAMW

## Main

Range of product	Harmony Timer Relays
Product or component type	Single function relay
Discrete output type	Solid state
Width	17.5 mm
Component name	RE17L
Time delay type	Power on-delay
Time delay range	1...10 s 10...100 h 6...60 s 0.1...1 s 1...10 min 6...60 min 1...10 h
Nominal output current	0.7 A

## Complementary

Control type	Selector switch front panel
[Us] rated supply voltage	24...240 V AC/DC 50/60 Hz
Voltage range	0.85...1.1 Us
Supply frequency	50...60 Hz +/- 5 %
Control signal pulse width	0.05 s typical
Insulation resistance	100 MOhm at 500 V DC conforming to IEC 60664-1
[Uimp] rated impulse withstand voltage	5 kV during 1.2/50 µs
Power on delay	100 ms
Connections - terminals	Screw terminals, 1 x 0.5...1 x 3.3 mm <sup>2</sup> (AWG 20...AWG 12) solid without cable end Screw terminals, 2 x 0.5...2 x 2.5 mm <sup>2</sup> (AWG 20...AWG 14) solid without cable end Screw terminals, 1 x 0.2...1 x 2.5 mm <sup>2</sup> (AWG 24...AWG 14) flexible with cable end Screw terminals, 2 x 0.2...2 x 1.5 mm <sup>2</sup> (AWG 24...AWG 16) flexible with cable end
Tightening torque	0.6...1 N.m conforming to IEC 60947-1
Dielectric strength	2.5 kV 1 mA/1 minute 50 Hz conforming to IEC 61812-1
Housing material	Self-extinguishing
Repeat accuracy	+/- 0.5 % conforming to IEC 61812-1
Temperature drift	+/- 0.05 %/°C

<b>Voltage drift</b>	+/- 0.2 %/V
<b>Setting accuracy of time delay</b>	+/- 10 % of full scale at 25 °C conforming to IEC 61812-1
<b>Reset time</b>	350 ms on de-energisation typical
<b>On-load factor</b>	100 %
<b>Power consumption in VA</b>	0...3 VA at 240 V AC
<b>Maximum power consumption in W</b>	1.5 W at 240 V DC
<b>Breaking capacity</b>	0.5 A AC/DC conforming to UL 0.7 A AC/DC at 20 °C
<b>Operating frequency</b>	10 Hz
<b>Maximum output current</b>	20 A
<b>Minimum switching current</b>	10 mA
<b>Maximum leakage current</b>	5 mA
<b>Maximum switching voltage</b>	250 V AC/DC
<b>Maximum voltage drop</b>	<4 V 3-wire <8 V 2-wire
<b>Electrical durability</b>	100000000 cycles
<b>Marking</b>	CE
<b>Creepage distance</b>	4 kV/3 conforming to IEC 60664-1
<b>Safety reliability data</b>	MTTFd = 353.8 years B10d = 320000
<b>Mounting position</b>	Any position in relation to normal vertical mounting plane
<b>Mounting support</b>	35 mm DIN rail conforming to EN/IEC 60715
<b>Net weight</b>	0.068 kg  A
<b>Functionality</b>	On-delay timing
<b>Compatibility code</b>	RE17

## Environment

<b>Immunity to microbreaks</b>	20 ms
<b>Derating factor</b>	5 mA/°C
<b>Standards</b>	2004/108/EC EN 61000-6-1 2006/95/EC EN 61000-6-3 EN 61000-6-2 IEC 61812-1 EN 61000-6-4
<b>Product certifications</b>	GL CSA cULus
<b>Ambient air temperature for storage</b>	-30...60 °C
<b>Ambient air temperature for operation</b>	-20...60 °C
<b>IP degree of protection</b>	IP20 (terminal block) conforming to IEC 60529 IP40 (housing) conforming to IEC 60529 IP50 (front panel) conforming to IEC 60529
<b>Vibration resistance</b>	20 m/s <sup>2</sup> (f= 10...150 Hz) conforming to IEC 60068-2-6
<b>Shock resistance</b>	15 gn for 11 ms conforming to IEC 60068-2-27
<b>Relative humidity</b>	93 % without condensation conforming to IEC 60068-2-30
<b>Electromagnetic compatibility</b>	Electrostatic discharge immunity test: (in contact), level 3, 6 kV, conforming to IEC 61000-4-2

Electrostatic discharge immunity test: (in air), level 3, 8 kV, conforming to IEC 61000-4-2  
 Susceptibility to electromagnetic fields: (80 MHz to 1 GHz), level 3, 10 V/m, conforming to IEC 61000-4-3  
 Electrical fast transient/burst immunity test: (capacitive connecting clip), level 3, 1 kV, conforming to IEC 61000-4-4  
 Electrical fast transient/burst immunity test: (direct), level 3, 2 kV, conforming to IEC 61000-4-4  
 1.2/50 µs shock waves immunity test: (differential mode), level 3, 1 kV, conforming to IEC 61000-4-5  
 1.2/50 µs shock waves immunity test: (common mode), level 3, 2 kV, conforming to IEC 61000-4-5  
 Conducted RF disturbances: (0.15...80 MHz), level 3, 10 V, conforming to IEC 61000-4-6  
 Voltage dips and interruptions immunity test: (1 cycle), 0 %, conforming to IEC 61000-4-11  
 Voltage dips and interruptions immunity test: (25/30 cycles), 70 %, conforming to IEC 61000-4-11  
 Conducted and radiated emissions: , class B, conforming to EN 55022

## Packing Units

Unit Type of Package 1	PCE
Number of Units in Package 1	1
Package 1 Height	2.600 cm
Package 1 Width	7.800 cm
Package 1 Length	9.500 cm
Package 1 Weight	70.000 g
Unit Type of Package 2	S02
Number of Units in Package 2	40
Package 2 Height	15.000 cm
Package 2 Width	30.000 cm
Package 2 Length	40.000 cm
Package 2 Weight	3.270 kg
Unit Type of Package 3	P06
Number of Units in Package 3	320
Package 3 Height	45.000 cm
Package 3 Width	60.000 cm
Package 3 Length	80.000 cm
Package 3 Weight	33.000 kg

## Offer Sustainability

Sustainable offer status	Green Premium product
REACH Regulation	<a href="#">REACH Declaration</a>
EU RoHS Directive	Pro-active compliance (Product out of EU RoHS legal scope) <a href="#">EU RoHS Declaration</a>
Mercury free	Yes
China RoHS Regulation	<a href="#">China RoHS declaration</a>
RoHS exemption information	<a href="#">Yes</a>
Environmental Disclosure	<a href="#">Product Environmental Profile</a>
Circularity Profile	<a href="#">End of Life Information</a>
California proposition 65	WARNING: This product can expose you to chemicals including: Lead and lead compounds, which is known to the State of California to cause cancer and birth defects or other reproductive harm. For more information go to <a href="http://www.P65Warnings.ca.gov">www.P65Warnings.ca.gov</a>

Width 17.5 mm

---

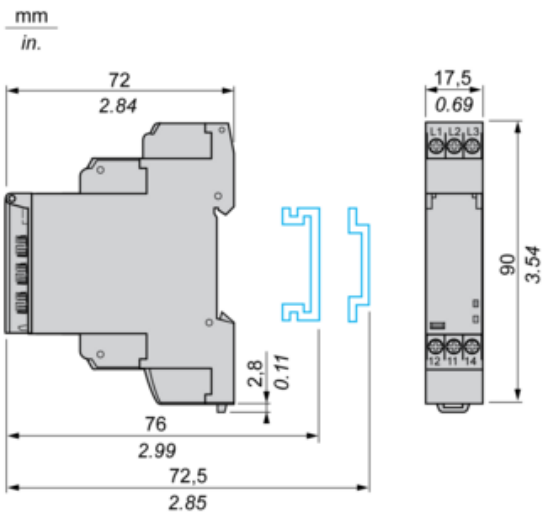

Internal Wiring Diagram

---

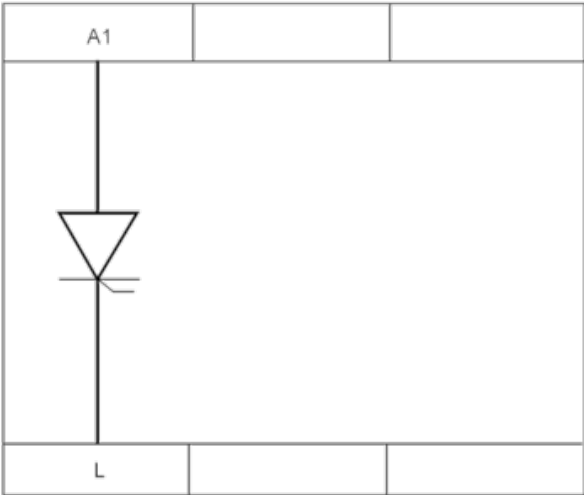

Wiring Diagram

---

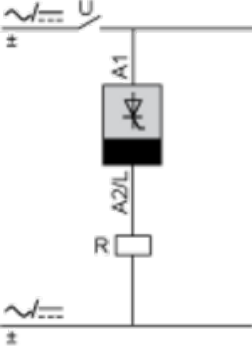

Function A : Power on Delay Relay

---

**Description**

The timing period T begins on energisation. After timing, the output(s) R close(s). The second output can be either timed or instantaneous.

**Function: 1 Output**





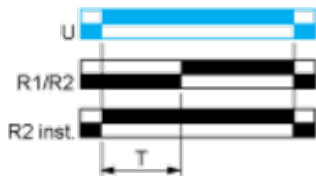

**Function: 2 Outputs**



2 timed outputs (R1/R2) or 1 timed output (R1) and 1 instantaneous output (R2 inst.)

**Legend**

---

-  Relay de-energised
-  Relay energised
-  Output open
-  Output closed

C	Control contact
G	Gate
R	Relay or solid state output
R1/R2	2 timed outputs
R2 inst.	The second output is instantaneous if the right position is selected
T	Timing period
Ta -	Adjustable On-delay
Tr -	Adjustable Off-delay
U	Supply

**Recommended replacement(s)**