

UT 35-PE - Ground terminal

3044241

<https://www.phoenixcontact.com/in/products/3044241>

Please be informed that the data shown in this PDF document is generated from our Online Catalog. Please find the complete data in the user documentation. Our General Terms of Use for Downloads are valid.



Ground terminal, number of connections: 2, connection method: Screw connection, Rated cross section: 35 mm², cross section: 1.5 mm² - 50 mm², mounting type: NS 35/7,5, NS 35/15, color: green-yellow

Your advantages

- The flexible options for reducing bridging in the CLIPLINE complete system can be found in "Accessories for the CLIPLINE complete modular terminal block system"
- Tested for railway applications

Commercial Data

Item number	3044241
Packing unit	50 pc
Minimum order quantity	50 pc
Sales Key	BE1
Product Key	BE1121
Catalog Page	Page 187 (C-1-2019)
GTIN	4017918977580
Weight per Piece (including packing)	88.475 g
Weight per Piece (excluding packing)	85.79 g
Customs tariff number	85369010
Country of origin	TR

UT 35-PE - Ground terminal



3044241

<https://www.phoenixcontact.com/in/products/3044241>

Technical Data

Product properties

Product type	Ground terminal block
Area of application	Railway industry
	Machine building
	Plant engineering
	Process industry
Number of connections	2
Number of rows	1

Insulation characteristics

Overvoltage category	III
Degree of pollution	3

Electrical properties

Rated surge voltage	8 kV
Maximum power dissipation for nominal condition	4.06 W

Connection data

Grounding foot	Yes
Number of connections per level	2
Nominal cross section	35 mm ²

Level 1 above 1 below 1

Screw thread	M6
Note	Please observe the current carrying capacity of the DIN rails.
Tightening torque	3.2 ... 3.7 Nm
Stripping length	18 mm
Internal cylindrical gage	B9
Connection in acc. with standard	IEC 60947-7-2
Conductor cross section rigid	1.5 mm ² ... 50 mm ²
Cross section AWG	16 ... 1/0 (converted acc. to IEC)
Conductor cross section flexible	1.5 mm ² ... 50 mm ²
Conductor cross section, flexible [AWG]	16 ... 1/0 (converted acc. to IEC)
Conductor cross-section flexible (ferrule without plastic sleeve)	1.5 mm ² ... 35 mm ²
Flexible conductor cross section (ferrule with plastic sleeve)	1.5 mm ² ... 35 mm ²
Note	Note: Product releases, connection cross sections and notes on connecting aluminum cables can be found in the download area.
Nominal cross section	35 mm ²

Ex data

Rated data (ATEX/IECEx)

Identification	<input type="checkbox"/> II 2 GD Ex eb IIC Gb
----------------	---

UT 35-PE - Ground terminal



3044241

<https://www.phoenixcontact.com/in/products/3044241>

Operating temperature range	-60 °C ... 110 °C
Ex-certified accessories	1205079 SZS 1,0X6,5 VDE
	3022276 CLIPFIX 35-5
	3022218 CLIPFIX 35
output	(Permanent)

Ex connection data General

Torque range	3.2 Nm ... 3.7 Nm
Nominal cross section	35 mm ²
Rated cross section AWG	2
Connection capacity rigid	1.5 mm ² ... 35 mm ²
Connection capacity AWG	16 ... 2
Connection capacity flexible	1.5 mm ² ... 35 mm ²
Connection capacity AWG	16 ... 2

Dimensions

Width	16 mm
End cover width	2.2 mm
Height	65.1 mm
Height NS 35/15	73.2 mm
Height NS 35/7,5	65.7 mm
Length	61.2 mm

Material specifications

Color	green-yellow
Flammability rating according to UL 94	V0
Insulating material group	I
Insulating material	PA
Static insulating material application in cold	-60 °C
Temperature index of insulation material (DIN EN 60216-1 (VDE 0304-21))	130 °C
Relative insulation material temperature index (Elec., UL 746 B)	130 °C
Fire protection for rail vehicles (DIN EN 45545-2) R22	HL 1 - HL 3
Fire protection for rail vehicles (DIN EN 45545-2) R23	HL 1 - HL 3
Fire protection for rail vehicles (DIN EN 45545-2) R24	HL 1 - HL 3
Fire protection for rail vehicles (DIN EN 45545-2) R26	HL 1 - HL 3
Calorimetric heat release NFPA 130 (ASTM E 1354)	28 MJ/kg
Surface flammability NFPA 130 (ASTM E 162)	passed
Specific optical density of smoke NFPA 130 (ASTM E 662)	passed
Smoke gas toxicity NFPA 130 (SMP 800C)	passed

Mechanical properties

Mechanical data

Open side panel	No
-----------------	----

Environmental and real-life conditions

Oscillation/broadband noise

Specification	DIN EN 50155 (VDE 0115-200):2018-05
Spectrum	Service life test category 2, bogie-mounted
Frequency	$f_1 = 5 \text{ Hz}$ to $f_2 = 250 \text{ Hz}$
ASD level	6.12 (m/s ²)/Hz
Acceleration	3.12g
Test duration per axis	5 h
Test directions	X-, Y- and Z-axis
Result	Test passed

Shocks

Specification	DIN EN 50155 (VDE 0115-200):2008-03
Pulse shape	Half-sine
Acceleration	5g
Shock duration	30 ms
Number of shocks per direction	3
Test directions	X-, Y- and Z-axis (pos. and neg.)
Result	Test passed

Ambient conditions

Ambient temperature (operation)	-60 °C ... 105 °C (max. short-term operating temperature RTI Elec.)
Ambient temperature (storage/transport)	-25 °C ... 60 °C (for a short time, not exceeding 24 h, -60 °C to +70 °C)
Ambient temperature (assembly)	-5 °C ... 70 °C
Ambient temperature (actuation)	-5 °C ... 70 °C
Permissible humidity (storage/transport)	30 % ... 70 %

Standards and regulations

Connection in acc. with standard	IEC 60947-7-2
----------------------------------	---------------

Mounting

Mounting type	NS 35/7,5
	NS 35/15

UT 35-PE - Ground terminal

3044241

<https://www.phoenixcontact.com/in/products/3044241>



Drawings

Schematic diagram

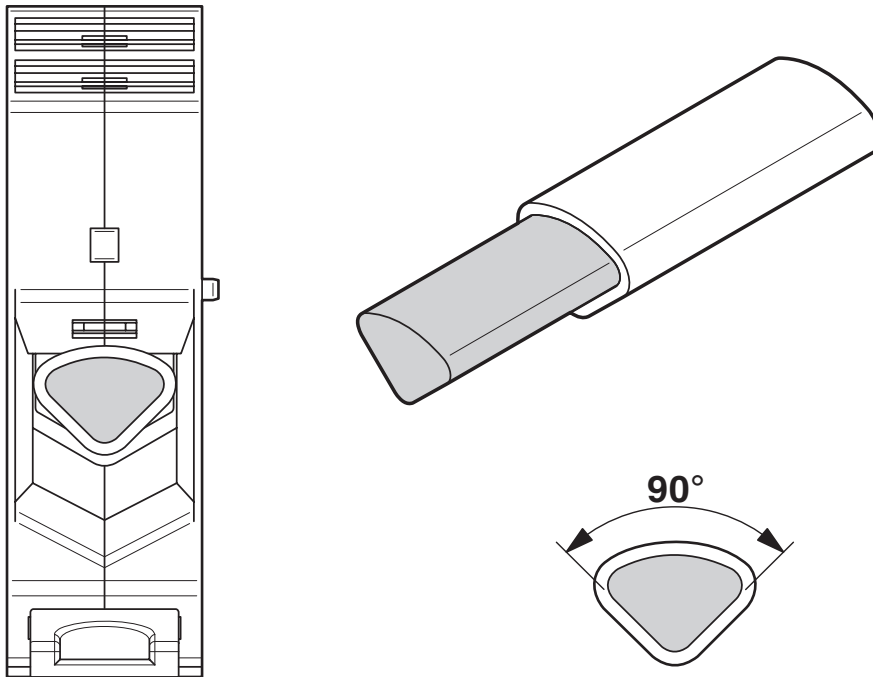

Connecting aluminum cables. Further notes can be found in the download area

Circuit diagram

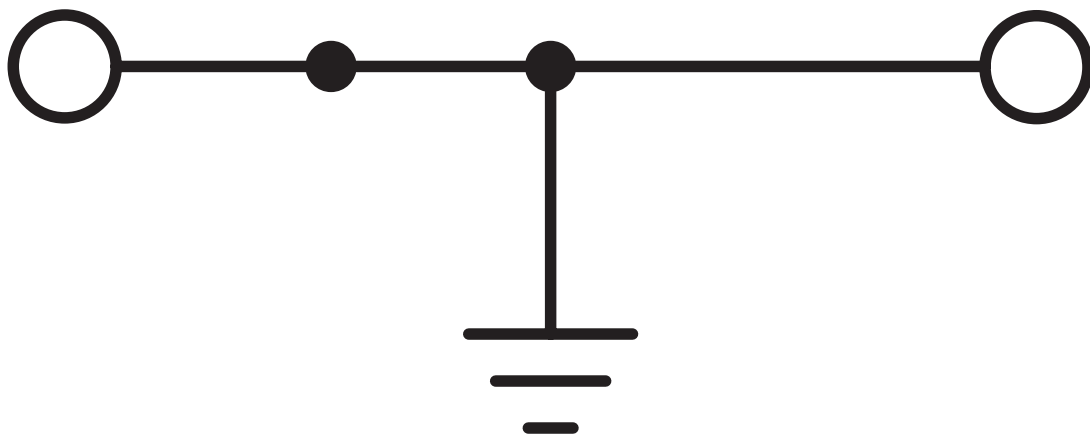

UT 35-PE - Ground terminal





3044241

<https://www.phoenixcontact.com/in/products/3044241>

Approvals

 CSA Approval ID: 13631				
	Nominal Voltage U_N	Nominal Current I_N	Cross Section AWG	Cross Section mm^2
	-	-	14 - 1/0	-
	-	-	14 - 1/0	-

 IECEE CB Scheme Approval ID: DE1-63048				
--	--	--	--	--

 EAC Approval ID: RU C-DE.AI30.B.01102				
---	--	--	--	--

 cULus Recognized Approval ID: E60425				
	Nominal Voltage U_N	Nominal Current I_N	Cross Section AWG	Cross Section mm^2
	-	-	14 - 2	-
	-	-	14 - 2	-
	-	-	14 - 2	-

 RS Approval ID: 22.44.01.00083.250				
--	--	--	--	--

 VDE Zeichengenehmigung Approval ID: 40020167				
	Nominal Voltage U_N	Nominal Current I_N	Cross Section AWG	Cross Section mm^2
	-	125 A	-	1.5 - 35

 ATEX Approval ID: KEMA04ATEX2048U				
---	--	--	--	--

 cUL Recognized Approval ID: E192998				
	Nominal Voltage U_N	Nominal Current I_N	Cross Section AWG	Cross Section mm^2
	-	-	14 - 2	-

 EAC Ex Approval ID: RU C-DE.HA91.B.00066				
--	--	--	--	--

UT 35-PE - Ground terminal



3044241

<https://www.phoenixcontact.com/in/products/3044241>



IECEX

Approval ID: IECEX KEM 06.0027U

	Nominal Voltage U_N	Nominal Current I_N	Cross Section AWG	Cross Section mm^2
	-	-	-	1.5 - 35



UL Recognized

Approval ID: E192998

	Nominal Voltage U_N	Nominal Current I_N	Cross Section AWG	Cross Section mm^2
	-	-	14 - 2	-



CCC

Approval ID: 2020322313000622



NEPSI

Approval ID: GYJ20.1194U



UKCA-EX

Approval ID: DEKRA 21UKEX0304U

UT 35-PE - Ground terminal



3044241

<https://www.phoenixcontact.com/in/products/3044241>

Classifications

ECLASS

ECLASS-11.0

27141141

ETIM

ETIM 8.0

EC000901

UNSPSC

UNSPSC 21.0

39121400

UT 35-PE - Ground terminal



3044241

<https://www.phoenixcontact.com/in/products/3044241>

Environmental Product Compliance

China RoHS	Environmentally friendly use period: unlimited = EFUP-e
	No hazardous substances above threshold values

UT 35-PE - Ground terminal

3044241

<https://www.phoenixcontact.com/in/products/3044241>



Accessories

i Note: Applying some accessories below might limit this product.

FBS 2-16 - Plug-in bridge

3005963

<https://www.phoenixcontact.com/in/products/3005963>



Plug-in bridge, pitch: 16 mm, number of positions: 2, length: 44 mm, color: red

i Max. current carrying capacity: 101 A

X-PEN 0,35 - Marker pen

0811228

<https://www.phoenixcontact.com/in/products/0811228>



Marker pen without ink cartridge, for manual labeling of markers, labeling extremely wipe-proof, line thickness 0.35 mm

UT 35-PE - Ground terminal

3044241

<https://www.phoenixcontact.com/in/products/3044241>



TPNS-UK - Partition plate

0706647

<https://www.phoenixcontact.com/in/products/0706647>

Partition plate, length: 80 mm, width: 2 mm, height: 70 mm, color: gray



WS UT 35 - Warning label

3047387

<https://www.phoenixcontact.com/in/products/3047387>

Warning sign for UT terminal blocks



UT 35-PE - Ground terminal

3044241

<https://www.phoenixcontact.com/in/products/3044241>



E/NS 35 N - End clamp

0800886

<https://www.phoenixcontact.com/in/products/0800886>

End clamp, width: 9.5 mm, color: gray



SZS 1,0X6,5 VDE - Screwdriver

1205079

<https://www.phoenixcontact.com/in/products/1205079>

Screwdriver, slot-headed, VDE insulated, size: 1.0 x 6.5 x 150 mm, 2-component grip, with non-slip grip



UT 35-PE - Ground terminal

3044241

<https://www.phoenixcontact.com/in/products/3044241>



NS 35/ 7,5 PERF 2000MM - DIN rail perforated

0801733

<https://www.phoenixcontact.com/in/products/0801733>



DIN rail perforated, acc. to EN 60715, material: Steel, galvanized, passivated with a thick layer, Standard profile, color: silver, Pack of 25 (50 m)

NS 35/ 7,5 UNPERF 2000MM - DIN rail, unperforated

0801681

<https://www.phoenixcontact.com/in/products/0801681>



DIN rail, unperforated, acc. to EN 60715, material: Steel, galvanized, passivated with a thick layer, Standard profile, color: silver, Pack of 25 (50 m)

UT 35-PE - Ground terminal

3044241

<https://www.phoenixcontact.com/in/products/3044241>



NS 35/ 7,5 WH PERF 2000MM - DIN rail perforated

1204119

<https://www.phoenixcontact.com/in/products/1204119>



DIN rail perforated, acc. to EN 60715, material: Steel, Galvanized, white passivated, Standard profile, color: silver, Pack of 25 (50 m)

NS 35/ 7,5 WH UNPERF 2000MM-VPE 10 - DIN rail, unperforated

1204122

<https://www.phoenixcontact.com/in/products/1204122>



DIN rail, unperforated, acc. to EN 60715, material: Steel, Galvanized, white passivated, Standard profile, color: silver, Pack of 10 (20 m)

UT 35-PE - Ground terminal

3044241

<https://www.phoenixcontact.com/in/products/3044241>



NS 35/ 7,5 AL UNPERF 2000MM - DIN rail, unperforated

0801704

<https://www.phoenixcontact.com/in/products/0801704>



DIN rail, unperforated, acc. to EN 60715, material: Aluminum, uncoated, Standard profile, color: silver, Pack of 25 (50 m)

NS 35/ 7,5 ZN PERF 2000MM - DIN rail perforated

1206421

<https://www.phoenixcontact.com/in/products/1206421>



DIN rail perforated, acc. to EN 60715, material: Steel, galvanized, Standard profile, color: silver, Pack of 25 (50 m)

UT 35-PE - Ground terminal

3044241

<https://www.phoenixcontact.com/in/products/3044241>



NS 35/ 7,5 ZN UNPERF 2000MM - DIN rail, unperforated

1206434

<https://www.phoenixcontact.com/in/products/1206434>



DIN rail, unperforated, acc. to EN 60715, material: Steel, galvanized, Standard profile, color: silver, Pack of 25 (50 m)

NS 35/ 7,5 CU UNPERF 2000MM-VPE 10 - DIN rail, unperforated

0801762

<https://www.phoenixcontact.com/in/products/0801762>



DIN rail, unperforated, acc. to EN 60715, material: Copper, uncoated, Standard profile, color: copper-colored, Pack of 10 (20 m)

UT 35-PE - Ground terminal

3044241

<https://www.phoenixcontact.com/in/products/3044241>



NS 35/ 7,5 CAP - End cap

1206560

<https://www.phoenixcontact.com/in/products/1206560>

DIN rail end piece, for DIN rail NS 35/7.5



NS 35/15 PERF 2000MM - DIN rail perforated

1201730

<https://www.phoenixcontact.com/in/products/1201730>



DIN rail perforated, similar to EN 60715, material: Steel, galvanized, passivated with a thick layer, Standard profile, color: silver, Pack of 25 (50 m)

UT 35-PE - Ground terminal

3044241

<https://www.phoenixcontact.com/in/products/3044241>



NS 35/15 UNPERF 2000MM - DIN rail, unperforated

1201714

<https://www.phoenixcontact.com/in/products/1201714>



DIN rail, unperforated, similar to EN 60715, material: Steel, galvanized, passivated with a thick layer, Standard profile, color: silver, Pack of 25 (50 m)

NS 35/15 WH PERF 2000MM - DIN rail perforated

0806602

<https://www.phoenixcontact.com/in/products/0806602>



DIN rail perforated, similar to EN 60715, material: Steel, Galvanized, white passivated, Standard profile, color: white, Pack of 25 (50 m)

UT 35-PE - Ground terminal

3044241

<https://www.phoenixcontact.com/in/products/3044241>



NS 35/15 WH UNPERF 2000MM-VPE 10 - DIN rail, unperforated

1204135

<https://www.phoenixcontact.com/in/products/1204135>



DIN rail, unperforated, similar to EN 60715, material: Steel, Galvanized, white passivated, Standard profile, color: silver, Pack of 10 (20 m)

NS 35/15 AL UNPERF 2000MM - DIN rail, unperforated

1201756

<https://www.phoenixcontact.com/in/products/1201756>



DIN rail, unperforated, similar to EN 60715, material: Aluminum, uncoated, Standard profile, color: silver

UT 35-PE - Ground terminal

3044241

<https://www.phoenixcontact.com/in/products/3044241>



NS 35/15 ZN PERF 2000MM - DIN rail perforated

1206599

<https://www.phoenixcontact.com/in/products/1206599>



DIN rail perforated, similar to EN 60715, material: Steel, galvanized, Standard profile, color: silver, Pack of 25 (50 m)

NS 35/15 ZN UNPERF 2000MM - DIN rail, unperforated

1206586

<https://www.phoenixcontact.com/in/products/1206586>



DIN rail, unperforated, similar to EN 60715, material: Steel, galvanized, Standard profile, color: silver, Pack of 25 (50 m)

UT 35-PE - Ground terminal

3044241

<https://www.phoenixcontact.com/in/products/3044241>



NS 35/15 CU UNPERF 2000MM-VPE 10 - DIN rail, unperforated

1201895

<https://www.phoenixcontact.com/in/products/1201895>



DIN rail, unperforated, similar to EN 60715, material: Copper, uncoated, Standard profile, color: copper-colored, Pack of 10 (20 m)

NS 35/15 CAP - End cap

1206573

<https://www.phoenixcontact.com/in/products/1206573>

DIN rail end piece, for DIN rail NS 35/15



UT 35-PE - Ground terminal

3044241

<https://www.phoenixcontact.com/in/products/3044241>



NS 35/15-2,3 UNPERF 2000MM-VPE 10 - DIN rail, unperforated

1201798

<https://www.phoenixcontact.com/in/products/1201798>



DIN rail, unperforated, acc. to EN 60715, material: Steel, galvanized, passivated with a thick layer, Standard profile 2.3 mm, color: silver, Pack of 10 (20 m)

ZB 16:UNPRINTED - Zack marker strip

0827461

<https://www.phoenixcontact.com/in/products/0827461>



Zack marker strip, Strip, white, unlabeled, can be labeled with: PLOTMARK, CMS-P1-PLOTTER, mounting type: snapped, for terminal block width: 16 mm, lettering field size: 16 x 10.5 mm, Number of individual labels: 50

UT 35-PE - Ground terminal

3044241

<https://www.phoenixcontact.com/in/products/3044241>



ZB 16 CUS - Zack marker strip

0827463

<https://www.phoenixcontact.com/in/products/0827463>



Zack marker strip, can be ordered: Strip, white, labeled according to customer specifications, mounting type: snap into tall marker groove, for terminal block width: 16 mm, lettering field size: 10.5 x 16 mm, Number of individual labels: 5

ZB 16,LGS:L1-N,PE - Zack marker strip

0827462

<https://www.phoenixcontact.com/in/products/0827462>



Zack marker strip, Strip, white, labeled, printed horizontally: L1, L2, L3, N, PE, mounting type: snapped, for terminal block width: 16.3 mm, lettering field size: 10.5 x 16.25 mm, Number of individual labels: 5

UT 35-PE - Ground terminal

3044241

<https://www.phoenixcontact.com/in/products/3044241>



UC-TM 16 - Marker for terminal blocks

0819217

<https://www.phoenixcontact.com/in/products/0819217>



Marker for terminal blocks, Sheet, white, unlabeled, can be labeled with: BLUEMARK ID COLOR, BLUEMARK ID, BLUEMARK CLED, PLOTMARK, CMS-P1-PLOTTER, mounting type: snapped, for terminal block width: 16 mm, lettering field size: 15.45 x 10.5 mm, Number of individual labels: 32

UC-TM 16 CUS - Marker for terminal blocks

0824621

<https://www.phoenixcontact.com/in/products/0824621>



Marker for terminal blocks, can be ordered: by sheet, white, labeled according to customer specifications, mounting type: snap into tall marker groove, for terminal block width: 16 mm, lettering field size: 15.45 x 10.5 mm, Number of individual labels: 32

UT 35-PE - Ground terminal

3044241

<https://www.phoenixcontact.com/in/products/3044241>



UCT-TM 16 - Marker for terminal blocks

0829146

<https://www.phoenixcontact.com/in/products/0829146>



Marker for terminal blocks, Sheet, white, unlabeled, can be labeled with: TOPMARK NEO, TOPMARK LASER, BLUEMARK ID COLOR, BLUEMARK ID, BLUEMARK CLED, THERMOMARK PRIME, THERMOMARK CARD 2.0, THERMOMARK CARD, mounting type: snapped, for terminal block width: 16 mm, lettering field size: 14.8 x 9.6 mm, Number of individual labels: 18

UCT-TM 16 CUS - Marker for terminal blocks

0829637

<https://www.phoenixcontact.com/in/products/0829637>



Marker for terminal blocks, can be ordered: by sheet, white, labeled according to customer specifications, mounting type: snap into tall marker groove, for terminal block width: 16 mm, lettering field size: 14.8 x 9.6 mm, Number of individual labels: 18

UT 35-PE - Ground terminal

3044241

<https://www.phoenixcontact.com/in/products/3044241>



PROJECT COMPLETE - Software

1050453

<https://www.phoenixcontact.com/in/products/1050453>



Intuitive planning and marking software for configuring terminal strips and for professional marking of marking materials for terminal blocks, conductors, cables, devices, and systems. The software is available for download

E/UK - End clamp

1201442

<https://www.phoenixcontact.com/in/products/1201442>



End clamp, material: PA, color: gray, Mounting on a DIN rail NS 32 or NS 35

UT 35-PE - Ground terminal

3044241

<https://www.phoenixcontact.com/in/products/3044241>



E/UK 1 - End clamp

1201413

<https://www.phoenixcontact.com/in/products/1201413>



End clamps, for supporting the ends of double-level and three-level terminal blocks, width: 10 mm, color: gray

CLIPFIX 35 - End clamp

3022218

<https://www.phoenixcontact.com/in/products/3022218>



Quick mounting end clamp for NS 35/7,5 DIN rail or NS 35/15 DIN rail, with marking option, width: 9.5 mm, color: gray

UT 35-PE - Ground terminal

3044241

<https://www.phoenixcontact.com/in/products/3044241>



CLIPFIX 35-5 - End clamp

3022276

<https://www.phoenixcontact.com/in/products/3022276>



Quick mounting end clamp for NS 35/7,5 DIN rail or NS 35/15 DIN rail, with marking option, with parking option for FBS...5, FBS...6, KSS 5, KSS 6, width: 5.15 mm, color: gray

Phoenix Contact 2023 © - all rights reserved

<https://www.phoenixcontact.com>

PHOENIX CONTACT (I) Pvt. Ltd.

A-58/2, Okhla Industrial Area, Phase - II, New Delhi-110 020

+91.1275.71420

info@phoenixcontact.co.in