

FKC 2,5/ 2-ST-5,08-RF - PCB connector



1925692

<https://www.phoenixcontact.com/in/products/1925692>

Please be informed that the data shown in this PDF document is generated from our Online Catalog. Please find the complete data in the user documentation. Our General Terms of Use for Downloads are valid.

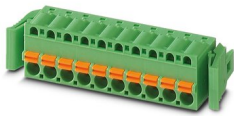

PCB connector, nominal cross section: 2.5 mm², color: green, nominal current: 12 A, rated voltage (III/2): 320 V, contact surface: Tin, type of contact: Socket, number of potentials: 2, number of rows: 1, number of positions: 2, number of connections: 2, product range: FKC 2,5/..-ST-RF, pitch: 5.08 mm, connection method: Push-in spring connection, conductor/PCB connection direction: 0 °, locking clip: - Locking clip, plug-in system: COMBICON MSTB 2,5, locking: Snap-in locking, mounting: Self-locking flange, type of packaging: packed in cardboard, Article with self-locking flange

Your advantages

- Time saving push-in connection, tools not required
- Intuitive use through colour coded actuation lever
- Quick and convenient testing using integrated test option
- Can be combined with the MSTB 2,5 range
- Intuitive locking mechanism prevents accidental disconnection

Commercial Data

Item number	1925692
Packing unit	100 pc
Minimum order quantity	100 pc
Sales Key	AAC
Product Key	AACFBG
Catalog Page	Page 275 (C-1-2013)
GTIN	4017918819750
Weight per Piece (including packing)	4.685 g
Weight per Piece (excluding packing)	4.471 g
Customs tariff number	85366990
Country of origin	DE

FKC 2,5/ 2-ST-5,08-RF - PCB connector



1925692

<https://www.phoenixcontact.com/in/products/1925692>

Technical Data

Product properties

Type	Standard
Product line	COMBICON Connectors M
Product type	PCB plug
Product family	FKC 2,5/...-ST-RF
Number of positions	2
Pitch	5.08 mm
Number of connections	2
Number of rows	1
Mounting flange	Self-locking flange
Number of potentials	2

Electrical properties

Nominal current I_N	12 A
Nominal voltage U_N	320 V
Degree of pollution	3
Contact resistance	0.8 m Ω
Rated voltage (III/3)	320 V
Rated surge voltage (III/3)	4 kV
Rated voltage (III/2)	320 V
Rated surge voltage (III/2)	4 kV
Rated voltage (II/2)	630 V
Rated surge voltage (II/2)	4 kV

Connection data

Connection technology

Type	Standard
Connector system	COMBICON MSTB 2,5
Nominal cross section	2.5 mm ²
Type of contact	Socket

Interlock

Locking type	Snap-in locking
Mounting flange	Self-locking flange

Conductor connection

Connection method	Push-in spring connection
Conductor/PCB connection direction	0 °
Conductor cross section rigid	0.2 mm ² ... 2.5 mm ²
Conductor cross section flexible	0.2 mm ² ... 2.5 mm ²
Conductor cross section AWG	24 ... 12
Conductor cross section flexible, with ferrule without plastic	0.25 mm ² ... 2.5 mm ²

FKC 2,5/ 2-ST-5,08-RF - PCB connector



1925692

<https://www.phoenixcontact.com/in/products/1925692>

sleeve	
Conductor cross section, flexible, with ferrule, with plastic sleeve	0.25 mm ² ... 2.5 mm ²
2 conductors with the same cross section, flexible, with TWIN ferrule with plastic sleeve	0.5 mm ² ... 1.5 mm ²
Cylindrical gauge a x b / diameter	2.8 mm x 2.0 mm / 2.0 mm
Stripping length	10 mm

Specifications for ferrules without insulating collar

recommended crimping tool	1212034 CRIMPFOX 6
ferrules without insulating collar, according to DIN 46228-1	Cross section: 0.5 mm ² ; Length: 8 mm ... 10 mm
	Cross section: 0.75 mm ² ; Length: 8 mm ... 10 mm
	Cross section: 1 mm ² ; Length: 8 mm ... 10 mm
	Cross section: 1.5 mm ² ; Length: 8 mm ... 10 mm
	Cross section: 2.5 mm ² ; Length: 10 mm

Specifications for ferrules with insulating collar

recommended crimping tool	1212034 CRIMPFOX 6
ferrules with insulating collar, according to DIN 46228-4	Cross section: 0.5 mm ² ; Length: 8 mm ... 10 mm
	Cross section: 0.75 mm ² ; Length: 8 mm ... 10 mm
	Cross section: 1 mm ² ; Length: 8 mm ... 10 mm
	Cross section: 1.5 mm ² ; Length: 8 mm ... 10 mm
	Cross section: 2.5 mm ² ; Length: 10 mm

Material specifications

Material data - contact

Note	WEEE/RoHS-compliant, free of whiskers according to IEC 60068-2-82/JEDEC JESD 201
Contact material	Cu alloy
Surface characteristics	hot-dip tin-plated
Metal surface terminal point (top layer)	Tin (4 - 8 µm Sn)
Metal surface contact area (top layer)	Tin (4 - 8 µm Sn)

Material data - housing

Color (Housing)	green (6021)
Insulating material	PA
Insulating material group	I
CTI according to IEC 60112	600
Flammability rating according to UL 94	V0
Glow wire flammability index GWFI according to EN 60695-2-12	850
Glow wire ignition temperature GWIT according to EN 60695-2-13	775
Temperature for the ball pressure test according to EN 60695-10-2	125 °C

Material data – actuating element

Color ()	()
-----------	-----

FKC 2,5/ 2-ST-5,08-RF - PCB connector

1925692

<https://www.phoenixcontact.com/in/products/1925692>

Insulating material	PBT
Insulating material group	I
CTI according to IEC 60112	600
Flammability rating according to UL 94	V0

Dimensions

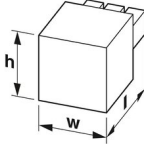
Dimensional drawing	
Pitch	5.08 mm
Width [w]	23.58 mm
Height [h]	15 mm
Length [l]	25.73 mm

Notes

General	In accordance with IEC 61984, COMBICON connectors have no switching power (COC). During designated use, they must not be plugged in or disconnected when carrying voltage or under load.
---------	--

Mechanical tests

Test for conductor damage and slackening

Specification	IEC 60999-1:1999-11
Result	Test passed

Repeated connection and disconnection

Specification	IEC 60999-1:1999-11
Result	Test passed

Pull-out test

Specification	IEC 60999-1:1999-11
Conductor cross section/conductor type/tractive force setpoint/actual value	0.2 mm ² / solid / > 10 N
	0.2 mm ² / flexible / > 10 N
	2.5 mm ² / solid / > 50 N
	2.5 mm ² / flexible / > 50 N

Insertion and withdrawal forces

Result	Test passed
No. of cycles	25
Insertion strength per pos. approx.	8 N
Withdraw strength per pos. approx.	6 N

Contact holder in insert

Specification	IEC 60512-15-1:2008-05
---------------	------------------------

FKC 2,5/ 2-ST-5,08-RF - PCB connector



1925692

<https://www.phoenixcontact.com/in/products/1925692>

Contact holder in insert Requirements >20 N	Test passed
Resistance of inscriptions	
Specification	IEC 60068-2-70:1995-12
Result	Test passed
Polarization and coding	
Specification	IEC 60512-13-5:2006-02
Result	Test passed
Visual inspection	
Specification	IEC 60512-1-1:2002-02
Result	Test passed
Dimension check	
Specification	IEC 60512-1-2:2002-02
Result	Test passed

Environmental and real-life conditions

Vibration test

Specification	IEC 60068-2-6:2007-12
Frequency	10 - 150 - 10 Hz
Sweep speed	1 octave/min
Amplitude	0.35 mm (10 Hz ... 60.1 Hz)
Sweep speed	5g (60.1 Hz ... 150 Hz)
Test duration per axis	2.5 h

Durability test

Specification	IEC 60512-9-1:2010-03
Impulse withstand voltage at sea level	4.8 kV
Contact resistance R_1	0.8 m Ω
Contact resistance R_2	0.9 m Ω
Insertion/withdrawal cycles	25
Insulation resistance, neighboring positions	> 5 M Ω

Climatic test

Specification	ISO 6988:1985-02
Corrosive stress	0.2 dm ³ SO ₂ on 300 dm ³ /40 °C/1 cycle
Thermal stress	100 °C/168 h
Power-frequency withstand voltage	2.21 kV

Ambient conditions

Ambient temperature (operation)	-40 °C ... 100 °C (dependent on the derating curve)
Ambient temperature (storage/transport)	-40 °C ... 70 °C
Relative humidity (storage/transport)	30 % ... 70 %
Ambient temperature (assembly)	-5 °C ... 100 °C

1925692

<https://www.phoenixcontact.com/in/products/1925692>

Electrical tests

Thermal test | Test group C

Specification	IEC 60512-5-1:2002-02
Tested number of positions	18

Insulation resistance

Specification	IEC 60512-3-1:2002-02
Insulation resistance, neighboring positions	> 5 MΩ

Air clearances and creepage distances |

Specification	IEC 60664-1:2007-04
Insulating material group	I
Comparative tracking index (IEC 60112)	CTI 600
Rated insulation voltage (III/3)	320 V
Rated surge voltage (III/3)	4 kV
minimum clearance value - non-homogenous field (III/3)	3 mm
minimum creepage distance (III/3)	4 mm
Rated insulation voltage (III/2)	320 V
Rated surge voltage (III/2)	4 kV
minimum clearance value - non-homogenous field (III/2)	3 mm
minimum creepage distance (III/2)	1.6 mm
Rated insulation voltage (II/2)	630 V
Rated surge voltage (II/2)	4 kV
minimum clearance value - non-homogenous field (II/2)	3 mm
minimum creepage distance (II/2)	3.2 mm

Packaging specifications

Type of packaging	packed in cardboard
-------------------	---------------------

Drawings

Diagram

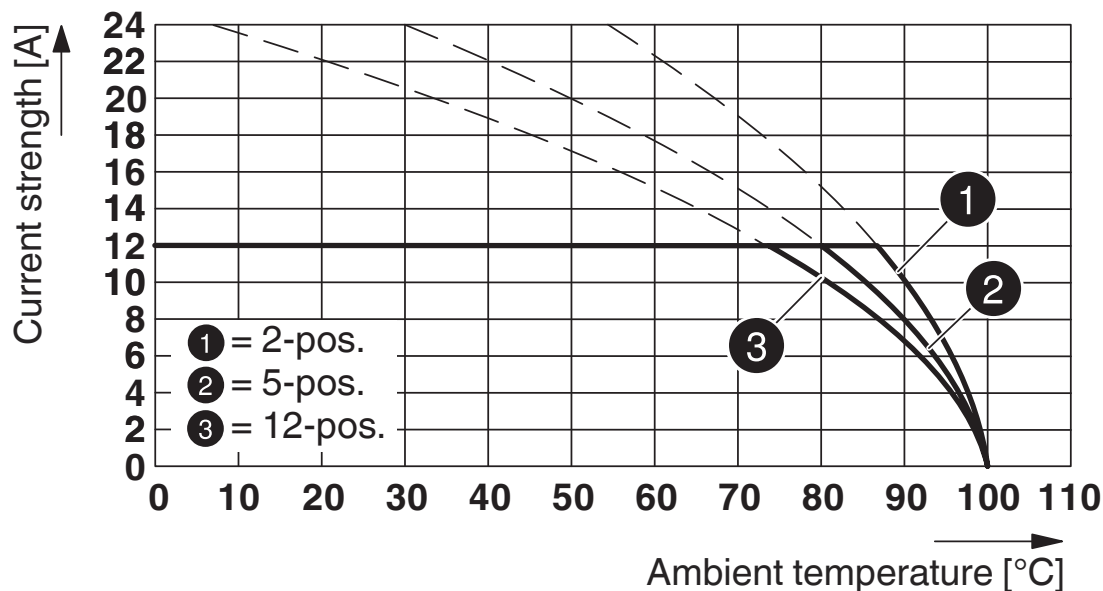

Type: FKC 2,5/...-ST-5,08-RF with CCVA 2,5/...-G-5,08 RNP26THR

Diagram

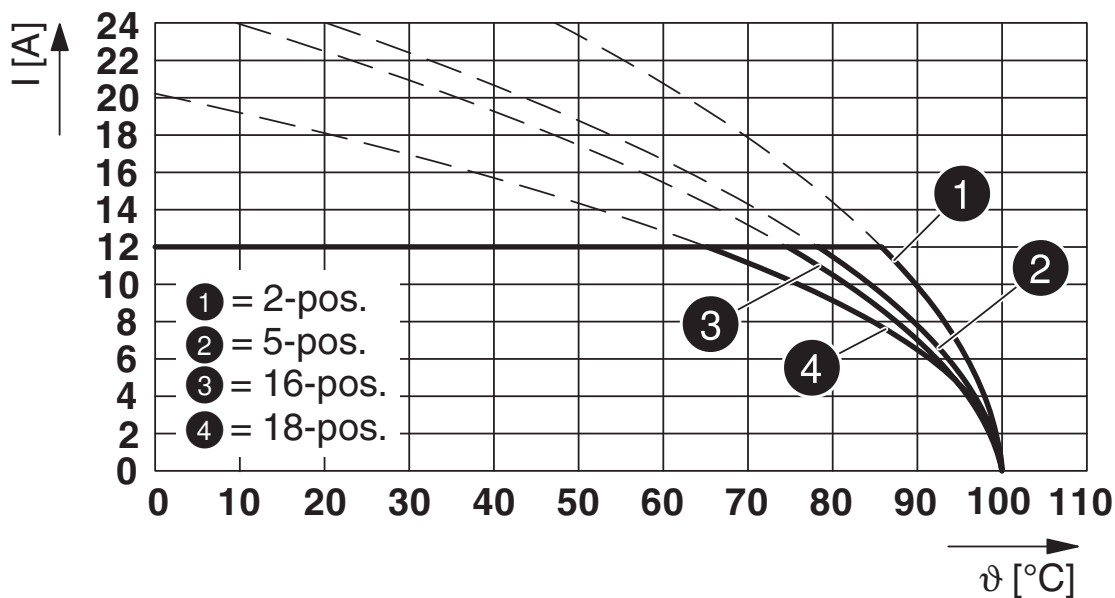

Type: FKC 2,5/...-ST-5,08-RF with MSTBA 2,5/...-G-5,08-RN

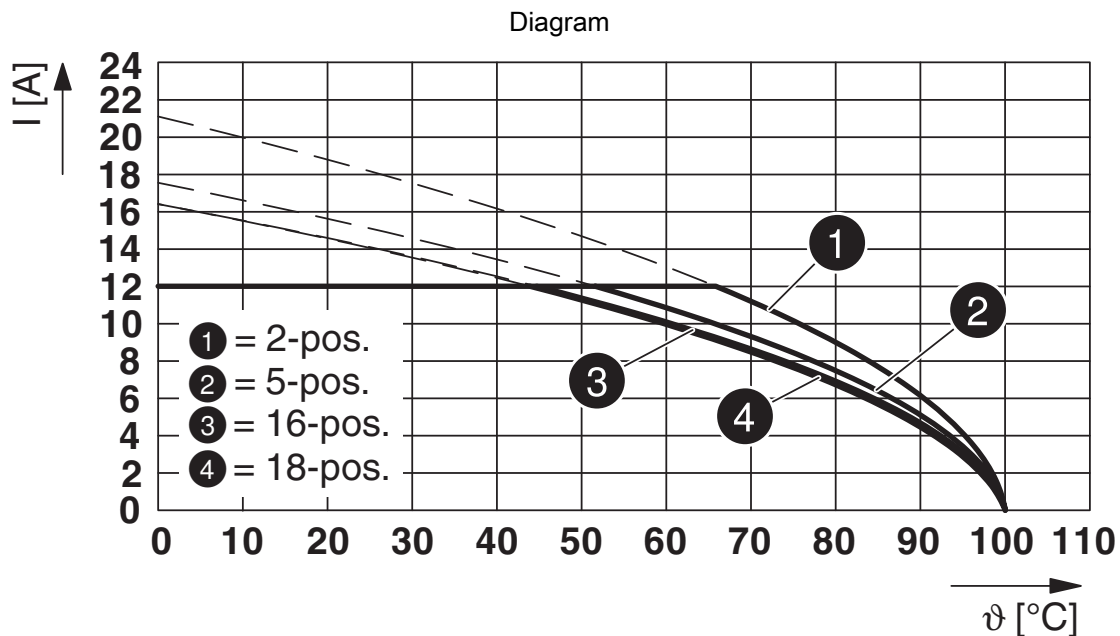

Type: FKC 2,5/...-ST-5,08-RF with MSTBVA 2,5/...-G-5,08-RN

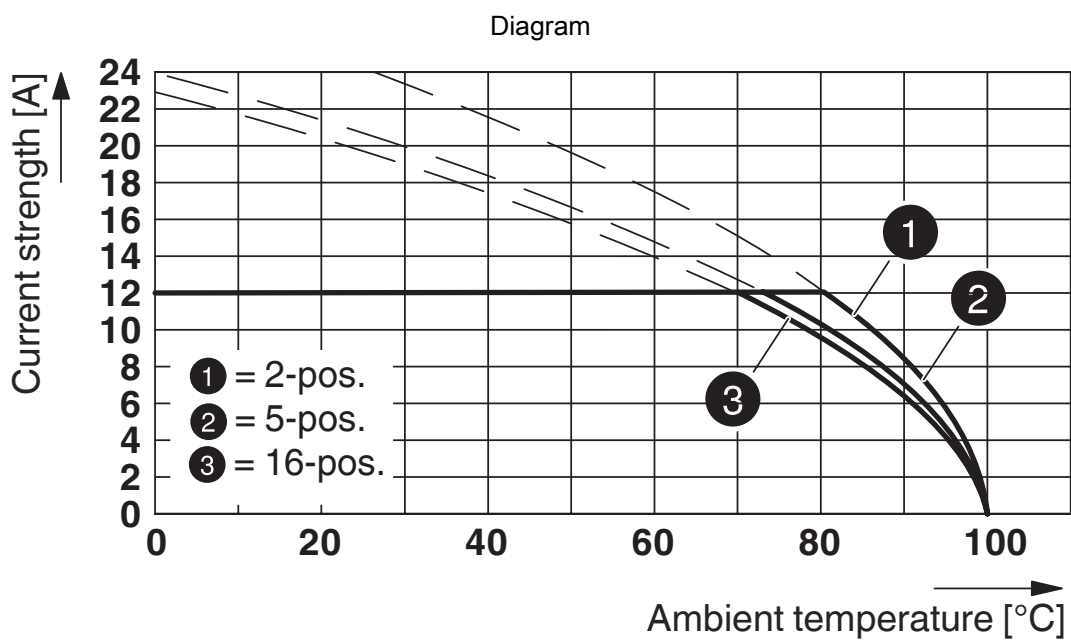

Type: FKC 2,5/...-ST-5,08-RF with FKICS 2,5/...-STD-5,08-RN

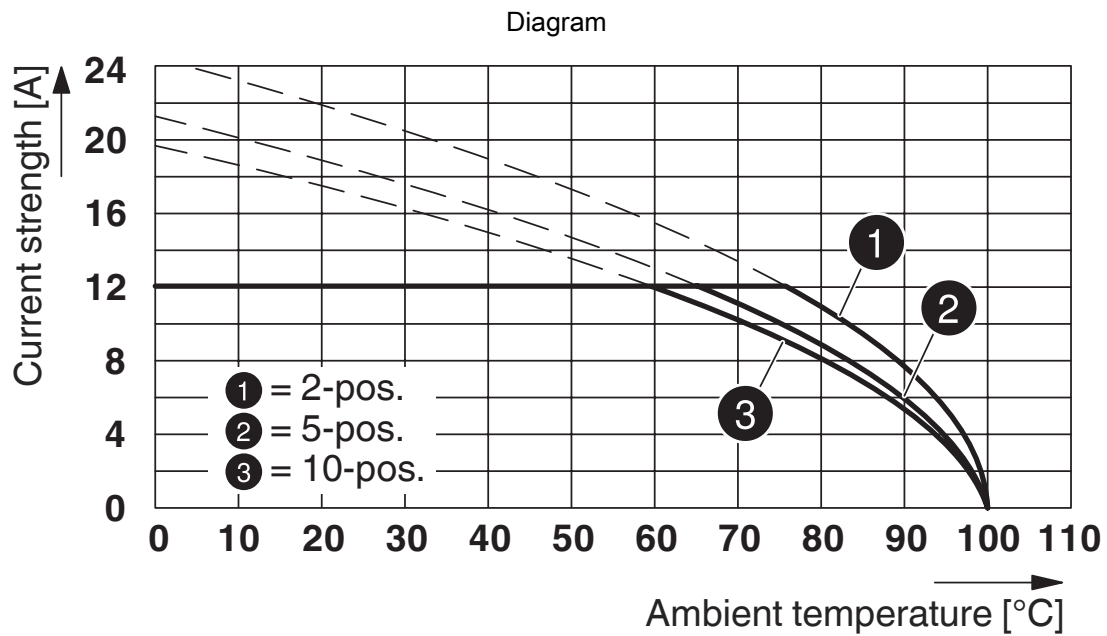

Type: FKC 2,5/...-ST-5,08 with CCA 2,5/...-G-5,08 RNP26THR

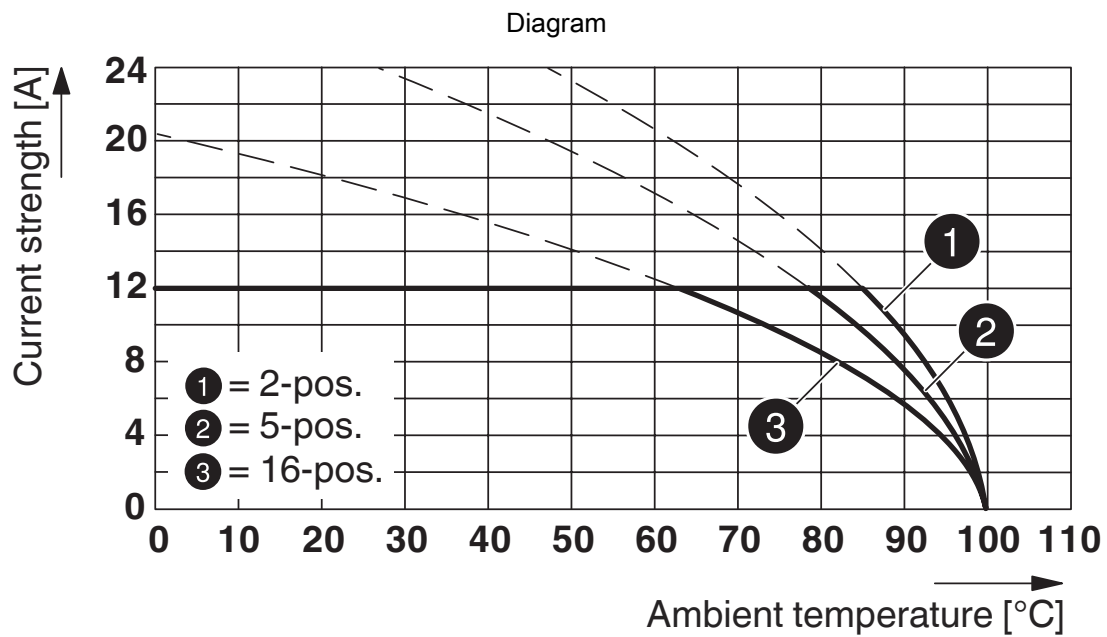

Type: FKC 2,5/...-ST-5,08-RF with FKIC 2,5/...-ST-5,08-RN

FKC 2,5/ 2-ST-5,08-RF - PCB connector





1925692

<https://www.phoenixcontact.com/in/products/1925692>

Approvals

 IECEE CB Scheme Approval ID: DE1-60988-B1B2				
	Nominal Voltage U_N	Nominal Current I_N	Cross Section AWG	Cross Section mm^2
	250 V	12 A	-	0.2 - 2.5

 EAC Approval ID: B.01687				
--	--	--	--	--

 cULus Recognized Approval ID: E60425-19931011				
	Nominal Voltage U_N	Nominal Current I_N	Cross Section AWG	Cross Section mm^2
	300 V	10 A	26 - 12	-
	300 V	10 A	26 - 12	-

 VDE Zeichengenehmigung Approval ID: 40050694				
	Nominal Voltage U_N	Nominal Current I_N	Cross Section AWG	Cross Section mm^2
	250 V	12 A	-	0.2 - 2.5

FKC 2,5/ 2-ST-5,08-RF - PCB connector



1925692

<https://www.phoenixcontact.com/in/products/1925692>

Classifications

ECLASS

ECLASS-11.0	27460202
ECLASS-12.0	27460202
ECLASS-13.0	27460202

ETIM

ETIM 8.0	EC002638
----------	----------

UNSPSC

UNSPSC 21.0	39121400
-------------	----------

FKC 2,5/ 2-ST-5,08-RF - PCB connector



1925692

<https://www.phoenixcontact.com/in/products/1925692>

Environmental Product Compliance

China RoHS	Environmentally friendly use period: unlimited = EFUP-e
	No hazardous substances above threshold values

FKC 2,5/ 2-ST-5,08-RF - PCB connector

1925692

<https://www.phoenixcontact.com/in/products/1925692>

Accessories

RPS - Reducing plug

0201647

<https://www.phoenixcontact.com/in/products/0201647>



Reducing plug, number of positions: 1, fuse type: , mounting type: , , color: gray

CP-MSTB - Coding profile

1734634

<https://www.phoenixcontact.com/in/products/1734634>



Coding profile, is inserted into the slot on the plug or inverted header, red insulating material

FKC 2,5/ 2-ST-5,08-RF - PCB connector



1925692

<https://www.phoenixcontact.com/in/products/1925692>

SZS 0,6X3,5 - Screwdriver

1205053

<https://www.phoenixcontact.com/in/products/1205053>



Actuation tool, for ST terminal blocks, insulated, also suitable for use as a bladed screwdriver, size: 0.6 x 3.5 x 100 mm, 2-component grip, with non-slip grip

CCA 2,5/ 2-G-5,08 RNP26THR - PCB header

1955167

<https://www.phoenixcontact.com/in/products/1955167>



PCB headers, nominal cross section: 2.5 mm², color: black, nominal current: 12 A, rated voltage (III/2): 320 V, contact surface: Tin, type of contact: Pin, number of potentials: 2, number of rows: 1, number of positions: 2, number of connections: 2, product range: CCA 2,5/..-G-RN, pitch: 5.08 mm, mounting: THR soldering, pin layout: Linear pinning, solder pin [P]: 2.6 mm, number of solder pins per potential: 1, plug-in system: COMBICON MSTB 2,5, Pin connector pattern alignment: Standard, locking: Snap-in locking, mounting: Engagement nose, type of packaging: packed in cardboard, Article with self-locking flange; user information and design recommendations on through-hole reflow technology can be found at: "Downloads"

FKC 2,5/ 2-ST-5,08-RF - PCB connector

1925692

<https://www.phoenixcontact.com/in/products/1925692>

CCVA 2,5/ 2-G-5,08 RNP26THR - PCB header

1956085

<https://www.phoenixcontact.com/in/products/1956085>



PCB headers, nominal cross section: 2.5 mm², color: black, nominal current: 12 A, rated voltage (III/2): 320 V, contact surface: Tin, type of contact: Pin, number of potentials: 2, number of rows: 1, number of positions: 2, number of connections: 2, product range: CCVA 2,5/...-G-RN, pitch: 5.08 mm, mounting: THR soldering, pin layout: Linear pinning, solder pin [P]: 2.6 mm, number of solder pins per potential: 1, plug-in system: COMBICON MSTB 2,5, Pin connector pattern alignment: Standard, locking: Snap-in locking, mounting: Engagement nose, type of packaging: packed in cardboard, Article with self-locking flange; user information and design recommendations on through-hole reflow technology can be found at: "Downloads"

CCA 2,5/ 2-G-5,08 RNP26THRR32 - PCB header

1955277

<https://www.phoenixcontact.com/in/products/1955277>



PCB headers, nominal cross section: 2.5 mm², color: black, nominal current: 12 A, rated voltage (III/2): 320 V, contact surface: Tin, type of contact: Pin, number of potentials: 2, number of rows: 1, number of positions: 2, number of connections: 2, product range: CCA 2,5/...-G-RN, pitch: 5.08 mm, mounting: THR soldering, pin layout: Linear pinning, solder pin [P]: 2.6 mm, number of solder pins per potential: 1, plug-in system: COMBICON MSTB 2,5, Pin connector pattern alignment: Standard, locking: Snap-in locking, mounting: Engagement nose, type of packaging: 32 mm wide tape, Article with self-locking flange; user information and design recommendations on through-hole reflow technology can be found at: "Downloads"

FKC 2,5/ 2-ST-5,08-RF - PCB connector

1925692

<https://www.phoenixcontact.com/in/products/1925692>



MSTBVA 2,5/ 2-G-5,08-RN - PCB header

1936018

<https://www.phoenixcontact.com/in/products/1936018>

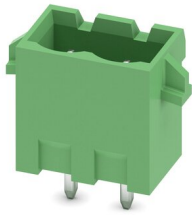

PCB headers, nominal cross section: 2.5 mm², color: green, nominal current: 12 A, rated voltage (III/2): 320 V, contact surface: Tin, type of contact: Pin, number of potentials: 2, number of rows: 1, number of positions: 2, number of connections: 2, product range: MSTBVA 2,5/...-G-RN, pitch: 5.08 mm, mounting: Wave soldering, pin layout: Linear pinning, solder pin [P]: 3.9 mm, number of solder pins per potential: 1, plug-in system: COMBICON MSTB 2,5, Pin connector pattern alignment: Standard, locking: Snap-in locking, mounting: Engagement nose, type of packaging: packed in cardboard, Article with engagement nose

ICC 2,5/ 2-STZ-5,08 - PCB connector

1823846

<https://www.phoenixcontact.com/in/products/1823846>



PCB connector, nominal cross section: 2.5 mm², color: green, nominal current: 12 A, rated voltage (III/2): 320 V, type of contact: Pin, number of potentials: 2, number of rows: 1, number of positions: 2, number of connections: 2, product range: ICC 2,5/...-STZ, pitch: 5.08 mm, connection method: Crimp connection, conductor/PCB connection direction: 0 °, locking clip: - without locking clip, plug-in system: COMBICON MSTB 2,5, locking: Snap-in locking, mounting: Engagement nose, type of packaging: packed in cardboard, Corresponding male crimp contacts with current [A] and conductor cross section range [mm²] data: 10A/ICC-MT 0,5-1,0 (3190577); 10A/ICC-MT 0,5-1,0 BA (3190603); 12A/ICC-MT 1,5-2,5 (3190580); 12A/ICC-MT 1,5-2,5 BA (3190593). BA = Bandkontakte

FKC 2,5/ 2-ST-5,08-RF - PCB connector

1925692

<https://www.phoenixcontact.com/in/products/1925692>

FKIC 2,5/ 3-ST-5,08-RN - PCB connector

1925870

<https://www.phoenixcontact.com/in/products/1925870>

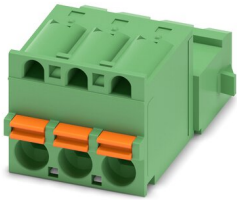

PCB connector, nominal cross section: 2.5 mm², color: green, nominal current: 12 A, rated voltage (III/2): 320 V, contact surface: Tin, type of contact: Pin, number of potentials: 3, number of rows: 1, number of positions: 3, number of connections: 3, product range: FKIC 2,5/...-ST-RN, pitch: 5.08 mm, connection method: Push-in spring connection, conductor/PCB connection direction: 0 °, locking clip: - without locking clip, plug-in system: COMBICON MSTB 2,5, locking: Snap-in locking, mounting: Engagement nose, type of packaging: packed in cardboard, Article with engagement nose

FKICS 2,5/ 3-STD-5,08-RN - PCB connector

1808734

<https://www.phoenixcontact.com/in/products/1808734>



PCB connector, nominal cross section: 2.5 mm², color: green, nominal current: 12 A, rated voltage (III/2): 320 V, contact surface: Tin, type of contact: Pin, number of potentials: 3, number of rows: 1, number of positions: 3, number of connections: 3, product range: FKICS 2,5/...-STD-RN, pitch: 5.08 mm, connection method: Push-in spring connection, conductor/PCB connection direction: 0 °, locking clip: - without locking clip, plug-in system: COMBICON MSTB 2,5, locking: Snap-in locking, mounting: Engagement nose, type of packaging: packed in cardboard

Phoenix Contact 2023 © - all rights reserved
<https://www.phoenixcontact.com>

PHOENIX CONTACT (I) Pvt. Ltd.
A-58/2, Okhla Industrial Area, Phase - II, New Delhi-110 020

+91.1275.71420
info@phoenixcontact.co.in