

FKIC 2,5 HC/ 3-ST-5,08 - PCB connector



1942604

<https://www.phoenixcontact.com/in/products/1942604>

Please be informed that the data shown in this PDF document is generated from our Online Catalog. Please find the complete data in the user documentation. Our General Terms of Use for Downloads are valid.

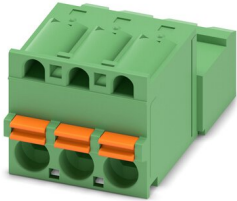

PCB connector, nominal cross section: 2.5 mm², color: green, nominal current: 16 A, rated voltage (III/2): 320 V, contact surface: Tin, type of contact: Pin, number of potentials: 3, number of rows: 1, number of positions: 3, number of connections: 3, product range: FKIC 2,5 HC/...-ST, pitch: 5.08 mm, connection method: Push-in spring connection, conductor/PCB connection direction: 0 °, locking clip: - without locking clip, plug-in system: COMBICON MSTB 2,5 HC, locking: without, mounting: without, type of packaging: packed in cardboard

Your advantages

- Time saving push-in connection, tools not required
- Defined contact force ensures that contact remains stable over the long term
- Intuitive use through colour coded actuation lever
- Inverted connector with pin contacts for touch-proof device outputs or free-hanging cable/cable connections
- Optimized for tight installation situations: operation and conductor connection from one direction
- Quick and convenient testing using integrated test option

Commercial Data

Item number	1942604
Packing unit	100 pc
Minimum order quantity	100 pc
Sales Key	AAC
Product Key	AACFKA
Catalog Page	Page 495 (C-1-2013)
GTIN	4017918879129
Weight per Piece (including packing)	5.274 g
Weight per Piece (excluding packing)	5 g
Customs tariff number	85366990
Country of origin	DE

FKIC 2,5 HC/ 3-ST-5,08 - PCB connector



1942604

<https://www.phoenixcontact.com/in/products/1942604>

Technical Data

Product properties

Type	Inverted
Product line	COMBICON Connectors M
Product type	PCB plug
Product family	FKIC 2,5 HC/...ST
Number of positions	3
Pitch	5.08 mm
Number of connections	3
Number of rows	1
Mounting flange	without
Number of potentials	3

Electrical properties

Nominal current I_N	16 A
Nominal voltage U_N	320 V
Degree of pollution	3
Contact resistance	0.9 m Ω
Rated voltage (III/3)	320 V
Rated surge voltage (III/3)	4 kV
Rated voltage (III/2)	320 V
Rated surge voltage (III/2)	4 kV
Rated voltage (II/2)	630 V
Rated surge voltage (II/2)	4 kV

Connection data

Connection technology

Type	Inverted
Connector system	COMBICON MSTB 2,5 HC
Nominal cross section	2.5 mm ²
Type of contact	Pin

Interlock

Locking type	without
Mounting flange	without

Conductor connection

Connection method	Push-in spring connection
Conductor/PCB connection direction	0 °
Conductor cross section rigid	0.2 mm ² ... 2.5 mm ²
Conductor cross section flexible	0.2 mm ² ... 2.5 mm ²
Conductor cross section AWG	24 ... 12
Conductor cross section flexible, with ferrule without plastic	0.25 mm ² ... 2.5 mm ²

FKIC 2,5 HC/ 3-ST-5,08 - PCB connector



1942604

<https://www.phoenixcontact.com/in/products/1942604>

sleeve	
Conductor cross section, flexible, with ferrule, with plastic sleeve	0.25 mm ² ... 2.5 mm ²
2 conductors with the same cross section, flexible, with TWIN ferrule with plastic sleeve	0.5 mm ² ... 1.5 mm ²
Cylindrical gauge a x b / diameter	2.8 mm x 2.0 mm / 2.3 mm
Stripping length	10 mm

Material specifications

Material data - contact

Note	WEEE/RoHS-compliant, free of whiskers according to IEC 60068-2-82/JEDEC JESD 201
Contact material	Cu alloy
Surface characteristics	hot-dip tin-plated
Metal surface terminal point (top layer)	Tin (5 - 7 µm Sn)
Metal surface contact area (top layer)	Tin (5 - 7 µm Sn)

Material data - housing

Color (Housing)	green (6021)
Insulating material	PA
Insulating material group	I
CTI according to IEC 60112	600
Flammability rating according to UL 94	V0
Glow wire flammability index GWFI according to EN 60695-2-12	850
Glow wire ignition temperature GWIT according to EN 60695-2-13	775
Temperature for the ball pressure test according to EN 60695-10-2	125 °C

Material data – actuating element

Color ()	()
Insulating material	PBT
Insulating material group	I
CTI according to IEC 60112	600
Flammability rating according to UL 94	V0

Dimensions

Dimensional drawing	
Pitch	5.08 mm
Width [w]	17.24 mm
Height [h]	15 mm
Length [l]	27 mm

Notes

Notes on operation	In accordance with IEC 61984, COMBICON connectors have no switching power (COC). During designated use, they must not be plugged in or disconnected when carrying voltage or under load.
--------------------	--

Mechanical tests

Test for conductor damage and slackening

Specification	IEC 60999-1:1999-11
Result	Test passed

Repeated connection and disconnection

Specification	IEC 60999-1:1999-11
Result	Test passed

Pull-out test

Specification	IEC 60999-1:1999-11
Conductor cross section/conductor type/tractive force setpoint/actual value	0.2 mm ² / solid / > 10 N
	0.2 mm ² / flexible / > 10 N
	2.5 mm ² / solid / > 50 N
	2.5 mm ² / flexible / > 50 N

Insertion and withdrawal forces

Result	Test passed
No. of cycles	50
Insertion strength per pos. approx.	8 N
Withdraw strength per pos. approx.	6 N

Contact holder in insert

Specification	IEC 60512-15-1:2008-05
Contact holder in insert Requirements >20 N	Test passed

Resistance of inscriptions

Specification	IEC 60068-2-70:1995-12
Result	Test passed

Polarization and coding

Specification	IEC 60512-13-5:2006-02
Result	Test passed

Visual inspection

Specification	IEC 60512-1-1:2002-02
Result	Test passed

Dimension check

Specification	IEC 60512-1-2:2002-02
Result	Test passed

Environmental and real-life conditions

Vibration test

Specification	IEC 60068-2-6:2007-12
Frequency	10 - 150 - 10 Hz
Sweep speed	1 octave/min
Amplitude	0.35 mm (10 Hz ... 60.1 Hz)
Sweep speed	5g (60.1 Hz ... 150 Hz)
Test duration per axis	2.5 h

Durability test

Specification	IEC 60512-9-1:2010-03
Impulse withstand voltage at sea level	4.8 kV
Contact resistance R_1	0.9 m Ω
Contact resistance R_2	1 m Ω
Insertion/withdrawal cycles	50
Insulation resistance, neighboring positions	> 5 M Ω

Climatic test

Specification	ISO 6988:1985-02
Corrosive stress	0.2 dm ³ SO ₂ on 300 dm ³ /40 °C/1 cycle
Thermal stress	100 °C/168 h
Power-frequency withstand voltage	2.21 kV

Ambient conditions

Ambient temperature (operation)	-40 °C ... 100 °C (dependent on the derating curve)
Ambient temperature (storage/transport)	-40 °C ... 70 °C
Relative humidity (storage/transport)	30 % ... 70 %
Ambient temperature (assembly)	-5 °C ... 100 °C

Electrical tests

Thermal test | Test group C

Specification	IEC 60512-5-1:2002-02
Tested number of positions	12

Insulation resistance

Specification	IEC 60512-3-1:2002-02
Insulation resistance, neighboring positions	> 5 M Ω

Air clearances and creepage distances |

Specification	IEC 60664-1:2007-04
Insulating material group	I
Comparative tracking index (IEC 60112)	CTI 600
Rated insulation voltage (III/3)	320 V
Rated surge voltage (III/3)	4 kV

FKIC 2,5 HC/ 3-ST-5,08 - PCB connector



1942604

<https://www.phoenixcontact.com/in/products/1942604>

minimum clearance value - non-homogenous field (III/3)	3 mm
minimum creepage distance (III/3)	4 mm
Rated insulation voltage (III/2)	320 V
Rated surge voltage (III/2)	4 kV
minimum clearance value - non-homogenous field (III/2)	3 mm
minimum creepage distance (III/2)	3 mm
Rated insulation voltage (II/2)	630 V
Rated surge voltage (II/2)	4 kV
minimum clearance value - non-homogenous field (II/2)	3 mm
minimum creepage distance (II/2)	3.2 mm

Packaging specifications

Type of packaging	packed in cardboard
-------------------	---------------------

Drawings

Diagram

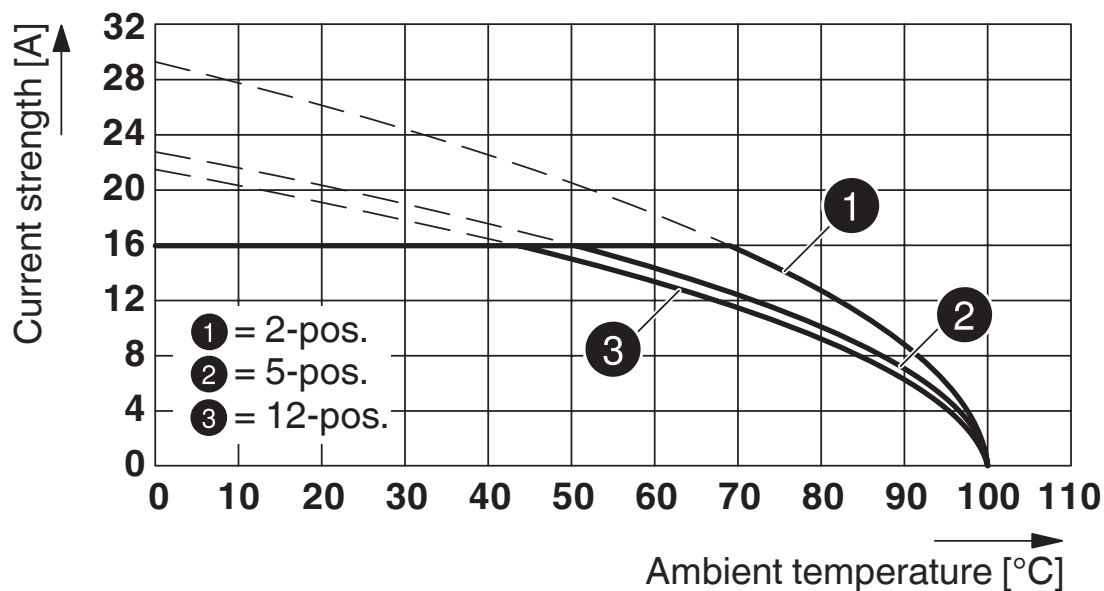

Type: FKIC 2,5 HC/...-ST- 5,08 with ICV 2,5 HC/...-G-5,08

Diagram

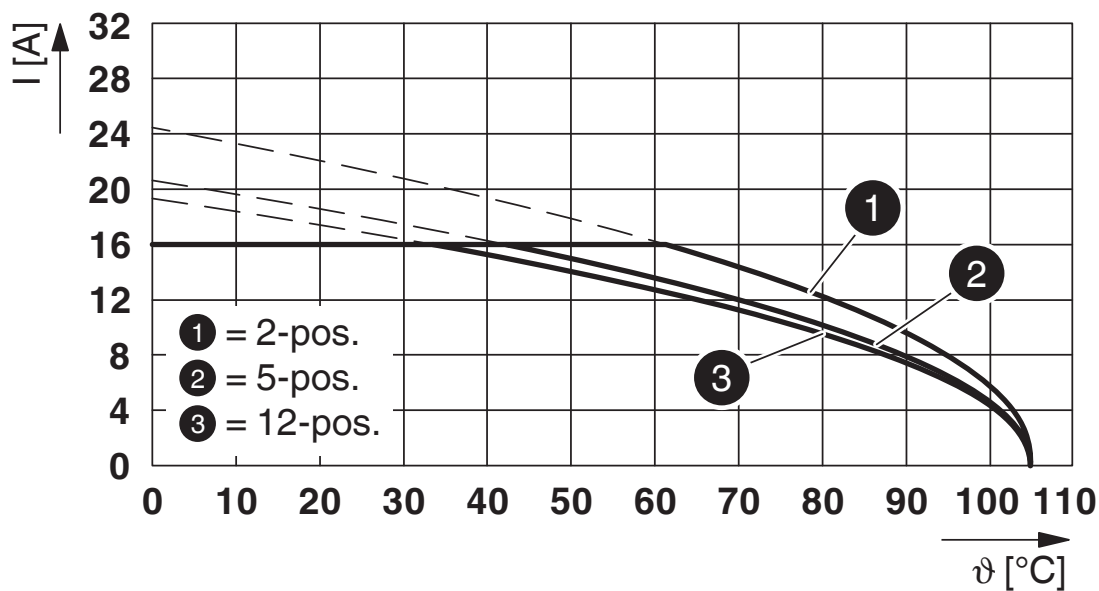

Type: FKIC 2,5 HC/...-ST-5,08 with IC 2,5 HC/...-G-5,08

1942604

<https://www.phoenixcontact.com/in/products/1942604>

Diagram

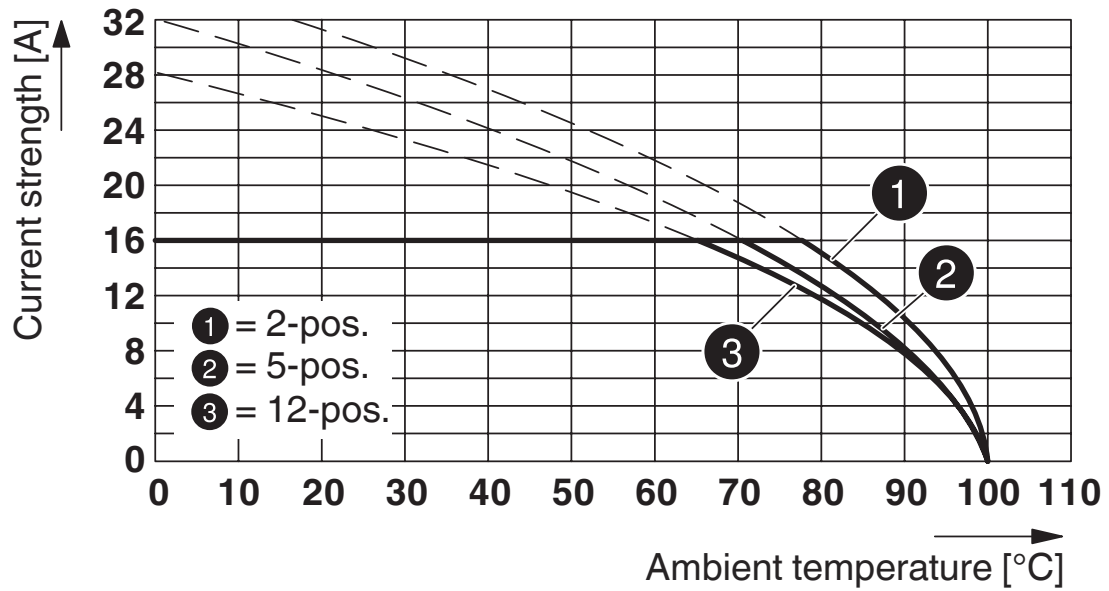

Type: FKIC 2,5 HC/...-ST- 5,08 with MSTB 2,5 HC/...-ST-5,08

Dimensional drawing

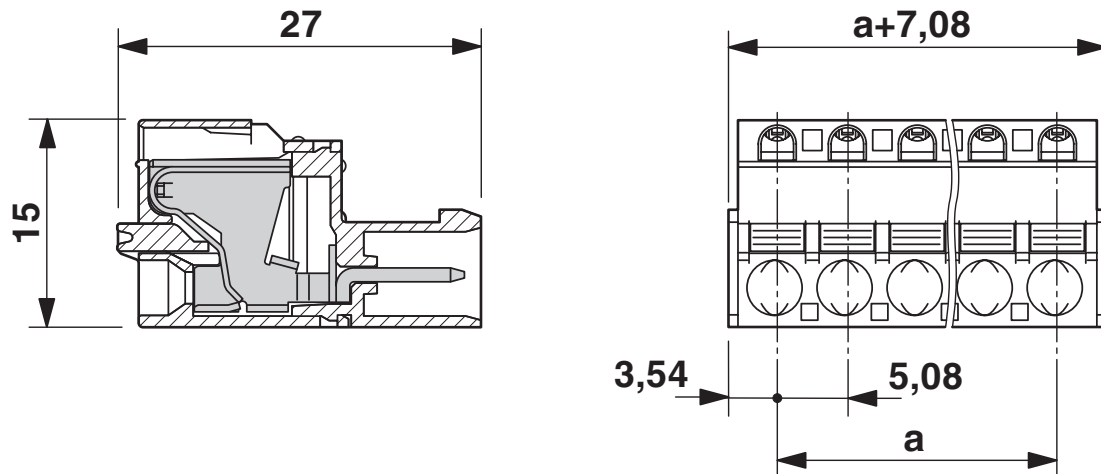

FKIC 2,5 HC/ 3-ST-5,08 - PCB connector





1942604

<https://www.phoenixcontact.com/in/products/1942604>

Approvals

 IECEE CB Scheme Approval ID: DE1-60988-B1B2				
	Nominal Voltage U_N	Nominal Current I_N	Cross Section AWG	Cross Section mm^2
	250 V	16 A	-	0.2 - 2.5

 EAC Approval ID: B.01687				
--	--	--	--	--

 cULus Recognized Approval ID: E60425-19931011				
	Nominal Voltage U_N	Nominal Current I_N	Cross Section AWG	Cross Section mm^2
	300 V	16 A	26 - 12	-
	300 V	10 A	26 - 12	-

 VDE Zeichengenehmigung Approval ID: 40050079				
	Nominal Voltage U_N	Nominal Current I_N	Cross Section AWG	Cross Section mm^2
	250 V	16 A	-	0.2 - 2.5

FKIC 2,5 HC/ 3-ST-5,08 - PCB connector



1942604

<https://www.phoenixcontact.com/in/products/1942604>

Classifications

ECLASS

ECLASS-11.0	27460202
ECLASS-12.0	27460202
ECLASS-13.0	27460202

ETIM

ETIM 8.0	EC002638
----------	----------

UNSPSC

UNSPSC 21.0	39121400
-------------	----------

FKIC 2,5 HC/ 3-ST-5,08 - PCB connector



1942604

<https://www.phoenixcontact.com/in/products/1942604>

Environmental Product Compliance

China RoHS	Environmentally friendly use period: unlimited = EFUP-e
	No hazardous substances above threshold values

FKIC 2,5 HC/ 3-ST-5,08 - PCB connector

1942604

<https://www.phoenixcontact.com/in/products/1942604>

Accessories

CR-MSTB - Coding section

1734401

<https://www.phoenixcontact.com/in/products/1734401>

Coding section, inserted into the recess in the header or the inverted plug, red insulating material



RPS - Reducing plug

0201647

<https://www.phoenixcontact.com/in/products/0201647>

Reducing plug, number of positions: 1, fuse type: , mounting type: , , color: gray



FKIC 2,5 HC/ 3-ST-5,08 - PCB connector



1942604

<https://www.phoenixcontact.com/in/products/1942604>

SZS 0,6X3,5 - Screwdriver

1205053

<https://www.phoenixcontact.com/in/products/1205053>



Actuation tool, for ST terminal blocks, insulated, also suitable for use as a bladed screwdriver, size: 0.6 x 3.5 x 100 mm, 2-component grip, with non-slip grip

SK U/3,8 WH:UNBEDRUCKT - Marker card

0803906

<https://www.phoenixcontact.com/in/products/0803906>



Marker card, Sheet, white, unlabeled, can be labeled with: PLOTMARK, CMS-P1-PLOTTER, Office printing systems, mounting type: adhesive, for terminal block width: 210 mm, lettering field size: 186 x 3.8 mm, Number of individual labels: 1440

FKIC 2,5 HC/ 3-ST-5,08 - PCB connector

1942604

<https://www.phoenixcontact.com/in/products/1942604>

SK 3,8 REEL P5,08 WH CUS - Marker card

0825125

<https://www.phoenixcontact.com/in/products/0825125>



Marker card, can be ordered: by card, white, labeled according to customer specifications, mounting type: adhesive, for terminal block width: 5.08 mm, lettering field size: continuous x 3.8 mm

SK 5,08/3,8:FORTL.ZAHLEN - Marker card

0804293

<https://www.phoenixcontact.com/in/products/0804293>

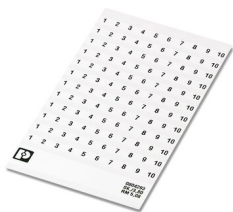

Marker card, white, labeled, horizontal: consecutive numbers 1 ... 10, 11 ... 20, etc. up to 91 ... (99)100, mounting type: adhesive, for terminal block width: 5.08 mm, lettering field size: 5.08 x 3.8 mm

FKIC 2,5 HC/ 3-ST-5,08 - PCB connector

1942604

<https://www.phoenixcontact.com/in/products/1942604>



SK 3,8 WH:REEL - Marker strip

0805218

<https://www.phoenixcontact.com/in/products/0805218>



Marker strip, Roll, white, unlabeled, can be labeled with: THERMOMARK E.300 (D)/600 (D), THERMOMARK ROLL 2.0, THERMOMARK ROLL, THERMOMARK ROLL X1, THERMOMARK ROLLMASTER 300/600, THERMOMARK X1.2, mounting type: adhesive, for terminal block width: 90000 mm, lettering field size: continuous x 3.8 mm, Number of individual labels: 210000

MPS-MT - Test plugs

0201744

<https://www.phoenixcontact.com/in/products/0201744>



Test plugs, with solder connection up to 1 mm² conductor cross section, number of positions: 1, fuse type: , mounting type: , , color: gray

FKIC 2,5 HC/ 3-ST-5,08 - PCB connector



1942604

<https://www.phoenixcontact.com/in/products/1942604>

MPS-IH WH - Insulating sleeve

0201663

<https://www.phoenixcontact.com/in/products/0201663>

Insulating sleeve, fuse type: , mounting type: , , color: white



MPS-IH RD - Insulating sleeve

0201676

<https://www.phoenixcontact.com/in/products/0201676>

Insulating sleeve, fuse type: , mounting type: , , color: red



FKIC 2,5 HC/ 3-ST-5,08 - PCB connector

1942604

<https://www.phoenixcontact.com/in/products/1942604>



MPS-IH BU - Insulating sleeve

0201689

<https://www.phoenixcontact.com/in/products/0201689>

Insulating sleeve, fuse type: , mounting type: , , color: blue

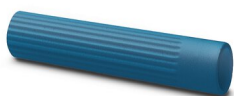

MPS-IH YE - Insulating sleeve

0201692

<https://www.phoenixcontact.com/in/products/0201692>

Insulating sleeve, fuse type: , mounting type: , , color: yellow



FKIC 2,5 HC/ 3-ST-5,08 - PCB connector

1942604

<https://www.phoenixcontact.com/in/products/1942604>



MPS-IH GN - Insulating sleeve

0201702

<https://www.phoenixcontact.com/in/products/0201702>

Insulating sleeve, fuse type: , mounting type: , , color: green



MPS-IH BK - Insulating sleeve

0201731

<https://www.phoenixcontact.com/in/products/0201731>

Insulating sleeve, fuse type: , mounting type: , , color: black



FKIC 2,5 HC/ 3-ST-5,08 - PCB connector

1942604

<https://www.phoenixcontact.com/in/products/1942604>

CRIMPFOX 6 - Crimping pliers

1212034

<https://www.phoenixcontact.com/in/products/1212034>



Crimping pliers, for ferrules without insulating collar according to DIN 46228 Part 1 and ferrules with insulating collar according to DIN 46228 Part 4, 0.25 mm² ... 6.0 mm², lateral entry, trapezoidal crimp

FKC 2,5 HC/ 3-ST-5,08 - PCB connector

1942387

<https://www.phoenixcontact.com/in/products/1942387>

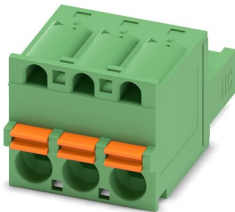

PCB connector, nominal cross section: 2.5 mm², color: green, nominal current: 16 A, rated voltage (III/2): 320 V, contact surface: Tin, type of contact: Socket, number of potentials: 3, number of rows: 1, number of positions: 3, number of connections: 3, product range: FKC 2,5 HC/..-ST, pitch: 5.08 mm, connection method: Push-in spring connection, conductor/PCB connection direction: 0 °, locking clip: - Locking clip, plug-in system: COMBICON MSTB 2,5 HC, locking: without, mounting: without, type of packaging: packed in cardboard

FKIC 2,5 HC/ 3-ST-5,08 - PCB connector



1942604

<https://www.phoenixcontact.com/in/products/1942604>

IC 2,5 HC/ 3-G-5,08 - PCB header

1943315

<https://www.phoenixcontact.com/in/products/1943315>

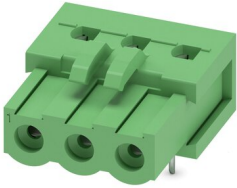

PCB headers, nominal cross section: 2.5 mm², color: green, nominal current: 16 A, rated voltage (III/2): 320 V, contact surface: Tin, type of contact: Socket, number of potentials: 3, number of rows: 1, number of positions: 3, number of connections: 3, product range: IC 2,5 HC/..-G, pitch: 5.08 mm, mounting: Wave soldering, pin layout: Linear pinning, solder pin [P]: 3.5 mm, number of solder pins per potential: 2, plug-in system: COMBICON MSTB 2,5 HC, Pin connector pattern alignment: Standard, locking: without, mounting: without, type of packaging: packed in cardboard

ICV 2,5 HC/ 3-G-5,08 - PCB header

1943548

<https://www.phoenixcontact.com/in/products/1943548>



PCB headers, nominal cross section: 2.5 mm², color: green, nominal current: 16 A, rated voltage (III/2): 320 V, contact surface: Tin, type of contact: Socket, number of potentials: 3, number of rows: 1, number of positions: 3, number of connections: 3, product range: ICV 2,5 HC/..-G, pitch: 5.08 mm, mounting: Wave soldering, pin layout: Linear pinning, solder pin [P]: 3.6 mm, number of solder pins per potential: 2, plug-in system: COMBICON MSTB 2,5 HC, Pin connector pattern alignment: Standard, locking: without, mounting: without, type of packaging: packed in cardboard

Phoenix Contact 2023 © - all rights reserved
<https://www.phoenixcontact.com>

PHOENIX CONTACT (I) Pvt. Ltd.
A-58/2, Okhla Industrial Area, Phase - II, New Delhi-110 020

+91.1275.71420
info@phoenixcontact.co.in