

# PC 4/ 6-STF-7,62 - PCB connector



1828281

<https://www.phoenixcontact.com/in/products/1828281>

Please be informed that the data shown in this PDF document is generated from our Online Catalog. Please find the complete data in the user documentation. Our General Terms of Use for Downloads are valid.



PCB connector, nominal cross section: 4 mm<sup>2</sup>, color: green, nominal current: 20 A, rated voltage (III/2): 630 V, contact surface: Tin, type of contact: Socket, number of potentials: 6, number of rows: 1, number of positions: 6, number of connections: 6, product range: PC 4/..-STF, pitch: 7.62 mm, connection method: Screw connection with tension sleeve, screw head form: L Slotted, conductor/PCB connection direction: 0 °, locking clip: - Locking clip, plug-in system: COMBICON PC 4, locking: Screw locking, mounting: Screw flange, type of packaging: packed in cardboard

## Your advantages

- Well-known connection principle allows worldwide use
- Low temperature rise, thanks to maximum contact force
- Allows connection of two conductors
- Integrated double steel spring provides additional safety in the event of temperature and power fluctuations
- Screwable flange for superior mechanical stability

## Commercial Data

Item number	1828281
Packing unit	50 pc
Minimum order quantity	50 pc
Sales Key	AAD
Product Key	AADAAD
Catalog Page	Page 513 (C-1-2013)
GTIN	4017918050511
Weight per Piece (including packing)	28.59 g
Weight per Piece (excluding packing)	27.477 g
Customs tariff number	85366990
Country of origin	DE

# PC 4/ 6-STF-7,62 - PCB connector



1828281

<https://www.phoenixcontact.com/in/products/1828281>

## Technical Data

### Product properties

Type	Standard
Product line	COMBICON Connectors L
Product type	PCB plug
Product family	PC 4/...-STF
Number of positions	6
Pitch	7.62 mm
Number of connections	6
Number of rows	1
Mounting flange	Screw flange
Number of potentials	6

### Electrical properties

Nominal current $I_N$	20 A
Nominal voltage $U_N$	630 V
Degree of pollution	3
Contact resistance	0.5 mΩ
Rated voltage (III/3)	400 V
Rated surge voltage (III/3)	6 kV
Rated voltage (III/2)	630 V
Rated surge voltage (III/2)	6 kV
Rated voltage (II/2)	1000 V
Rated surge voltage (II/2)	6 kV

### Connection data

#### Connection technology

Type	Standard
Connector system	COMBICON PC 4
Nominal cross section	4 mm <sup>2</sup>
Type of contact	Socket

#### Interlock

Locking type	Screw locking
Mounting flange	Screw flange
Tightening torque	0.3 Nm ... 0.7 Nm

#### Conductor connection

Connection method	Screw connection with tension sleeve
Conductor/PCB connection direction	0 °
Conductor cross section rigid	0.2 mm <sup>2</sup> ... 4 mm <sup>2</sup>
Conductor cross section flexible	0.2 mm <sup>2</sup> ... 4 mm <sup>2</sup>
Conductor cross section AWG	24 ... 10

# PC 4/ 6-STF-7,62 - PCB connector

1828281

<https://www.phoenixcontact.com/in/products/1828281>

Conductor cross section flexible, with ferrule without plastic sleeve	0.25 mm <sup>2</sup> ... 4 mm <sup>2</sup>
Conductor cross section, flexible, with ferrule, with plastic sleeve	0.25 mm <sup>2</sup> ... 4 mm <sup>2</sup>
2 conductors with same cross section, solid	0.2 mm <sup>2</sup> ... 2.5 mm <sup>2</sup>
2 conductors with same cross section, flexible	0.2 mm <sup>2</sup> ... 1.5 mm <sup>2</sup>
2 conductors with same cross section, flexible, with ferrule without plastic sleeve	0.25 mm <sup>2</sup> ... 1.5 mm <sup>2</sup>
2 conductors with the same cross section, flexible, with TWIN ferrule with plastic sleeve	0.5 mm <sup>2</sup> ... 2.5 mm <sup>2</sup>
Cylindrical gauge a x b / diameter	3.6 mm x 3.1 mm / 3.0 mm
Stripping length	7 mm
Tightening torque	0.5 Nm ... 0.6 Nm

## Material specifications

### Material data - contact

Note	WEEE/RoHS-compliant, free of whiskers according to IEC 60068-2-82/JEDEC JESD 201
Contact material	Cu alloy
Surface characteristics	hot-dip tin-plated
Metal surface terminal point (top layer)	Tin (4 - 8 µm Sn)
Metal surface contact area (top layer)	Tin (4 - 8 µm Sn)

### Material data - housing

Color (Housing)	green (6021)
Insulating material	PA
Insulating material group	I
CTI according to IEC 60112	600
Flammability rating according to UL 94	V0
Glow wire flammability index GWFI according to EN 60695-2-12	850
Glow wire ignition temperature GWIT according to EN 60695-2-13	775
Temperature for the ball pressure test according to EN 60695-10-2	125 °C

### Material data – actuating element

Color ( )	( )
-----------	-----

## Dimensions

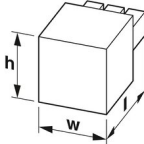
Dimensional drawing	
Pitch	7.62 mm
Width [w]	60.94 mm
Height [h]	18.1 mm

# PC 4/ 6-STF-7,62 - PCB connector



1828281

<https://www.phoenixcontact.com/in/products/1828281>

Length [l]	30.7 mm
------------	---------

## Mounting

Drive form screw head	Slotted (L)
Drive form screw head	Slotted (L)

## Flange

Tightening torque	0.3 Nm ... 0.7 Nm
-------------------	-------------------

## Notes

Notes on operation	In accordance with IEC 61984, COMBICON connectors have no switching power (COC). During designated use, they must not be plugged in or disconnected when carrying voltage or under load.
--------------------	--

## Mechanical tests

### Test for conductor damage and slackening

Specification	IEC 60999-1:1999-11
Result	Test passed

### Pull-out test

Specification	IEC 60999-1:1999-11
Conductor cross section/conductor type/tractive force setpoint/actual value	0.2 mm <sup>2</sup> / solid / > 10 N
	0.2 mm <sup>2</sup> / flexible / > 10 N
	4 mm <sup>2</sup> / solid / > 60 N
	4 mm <sup>2</sup> / flexible / > 60 N

### Insertion and withdrawal forces

Result	Test passed
No. of cycles	50
Insertion strength per pos. approx.	8 N
Withdraw strength per pos. approx.	5 N

### Torque test

Specification	IEC 60999-1:1999-11
---------------	---------------------

### Contact holder in insert

Specification	IEC 60512-15-1:2008-05
Contact holder in insert Requirements >20 N	Test passed

### Resistance of inscriptions

Specification	IEC 60068-2-70:1995-12
Result	Test passed

### Polarization and coding

Specification	IEC 60512-13-5:2006-02
Result	Test passed

# PC 4/ 6-STF-7,62 - PCB connector



1828281

<https://www.phoenixcontact.com/in/products/1828281>

## Visual inspection

Specification	IEC 60512-1-1:2002-02
Result	Test passed

## Dimension check

Specification	IEC 60512-1-2:2002-02
Result	Test passed

## Environmental and real-life conditions

### Vibration test

Specification	IEC 60068-2-6:2007-12
Frequency	10 - 150 - 10 Hz
Sweep speed	1 octave/min
Amplitude	0.35 mm (10 Hz ... 60.1 Hz)
Sweep speed	5g (60.1 Hz ... 150 Hz)
Test duration per axis	2.5 h

### Durability test

Specification	IEC 60512-9-1:2010-03
Impulse withstand voltage at sea level	7.3 kV
Contact resistance $R_1$	0.5 m $\Omega$
Contact resistance $R_2$	0.6 m $\Omega$
Insertion/withdrawal cycles	50

### Climatic test

Specification	ISO 6988:1985-02
Corrosive stress	0.2 dm <sup>3</sup> SO <sub>2</sub> on 300 dm <sup>3</sup> /40 °C/1 cycle
Thermal stress	100 °C/168 h
Power-frequency withstand voltage	3.31 kV

### Shocks

Specification	IEC 60068-2-27:2008-02
Pulse shape	Half-sine
Acceleration	30g
Shock duration	18 ms
Test directions	X-, Y- and Z-axis (pos. and neg.)

### Ambient conditions

Ambient temperature (operation)	-40 °C ... 100 °C (dependent on the derating curve)
Ambient temperature (storage/transport)	-40 °C ... 70 °C
Relative humidity (storage/transport)	30 % ... 70 %
Ambient temperature (assembly)	-5 °C ... 100 °C

## Electrical tests

Thermal test | Test group C

# PC 4/ 6-STF-7,62 - PCB connector



1828281

<https://www.phoenixcontact.com/in/products/1828281>

Specification	IEC 60512-5-1:2002-02
Tested number of positions	12

## Insulation resistance

Specification	IEC 60512-3-1:2002-02
Insulation resistance, neighboring positions	> 5 MΩ

## Air clearances and creepage distances |

Specification	IEC 60664-1:2007-04
Insulating material group	I
Comparative tracking index (IEC 60112)	CTI 600
Rated insulation voltage (III/3)	400 V
Rated surge voltage (III/3)	6 kV
minimum clearance value - non-homogenous field (III/3)	5.5 mm
minimum creepage distance (III/3)	5.5 mm
Rated insulation voltage (III/2)	630 V
Rated surge voltage (III/2)	6 kV
minimum clearance value - non-homogenous field (III/2)	5.5 mm
minimum creepage distance (III/2)	5.5 mm
Rated insulation voltage (II/2)	1000 V
Rated surge voltage (II/2)	6 kV
minimum clearance value - non-homogenous field (II/2)	5.5 mm
minimum creepage distance (II/2)	5.5 mm

## Packaging specifications

Type of packaging	packed in cardboard
-------------------	---------------------

Drawings

Diagram

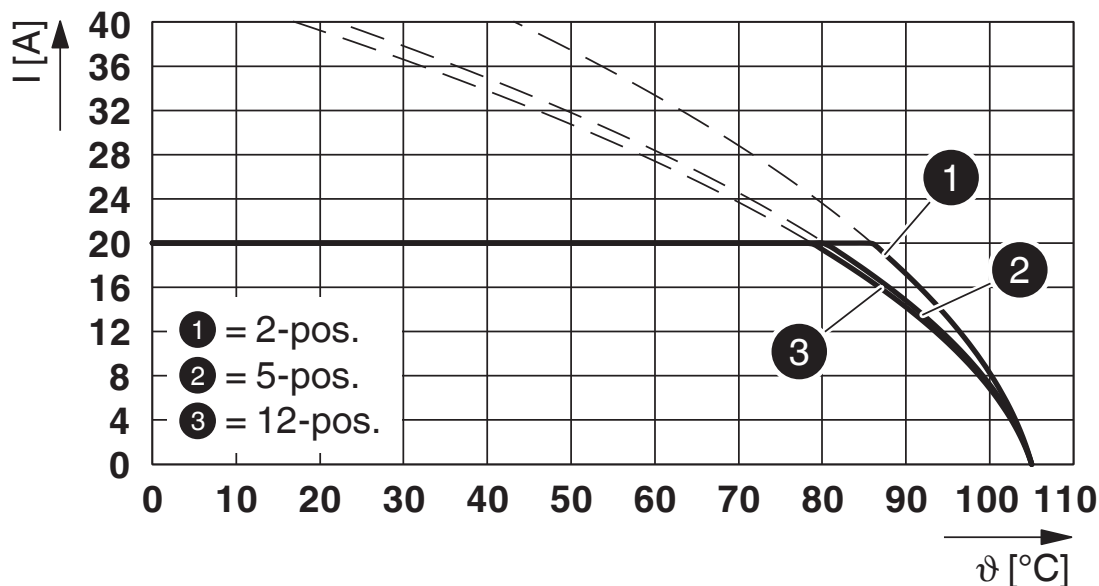

Type: PC 4/...-STF-7,62 with PC 5/...-GF-7,62

Diagram

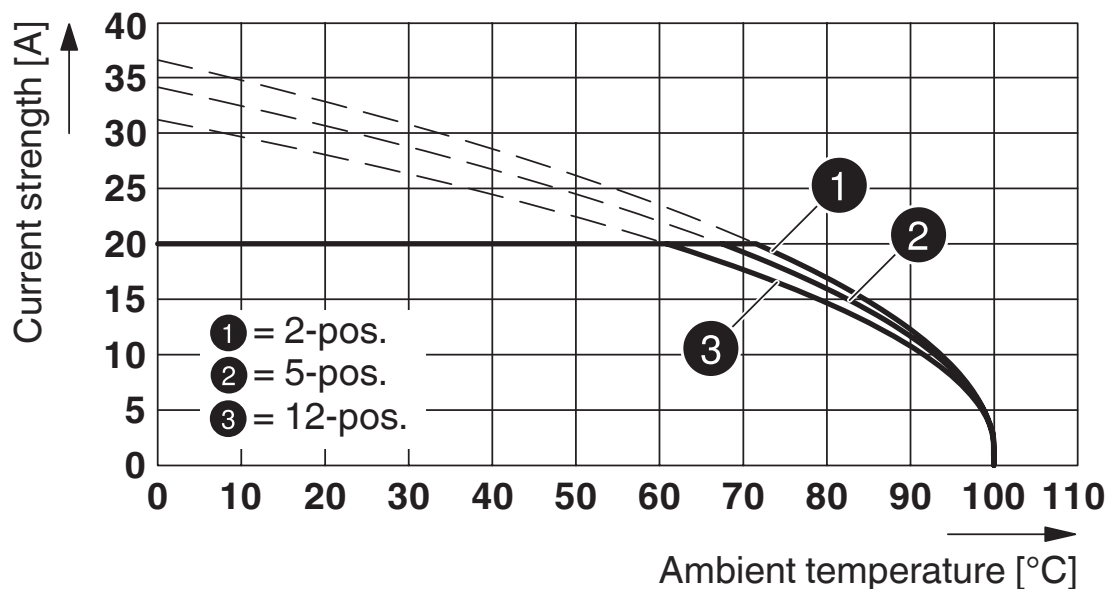

Type: PC 4/...-STF-7,62 with PCV 4/...-G-7,62 and BF-PC 4

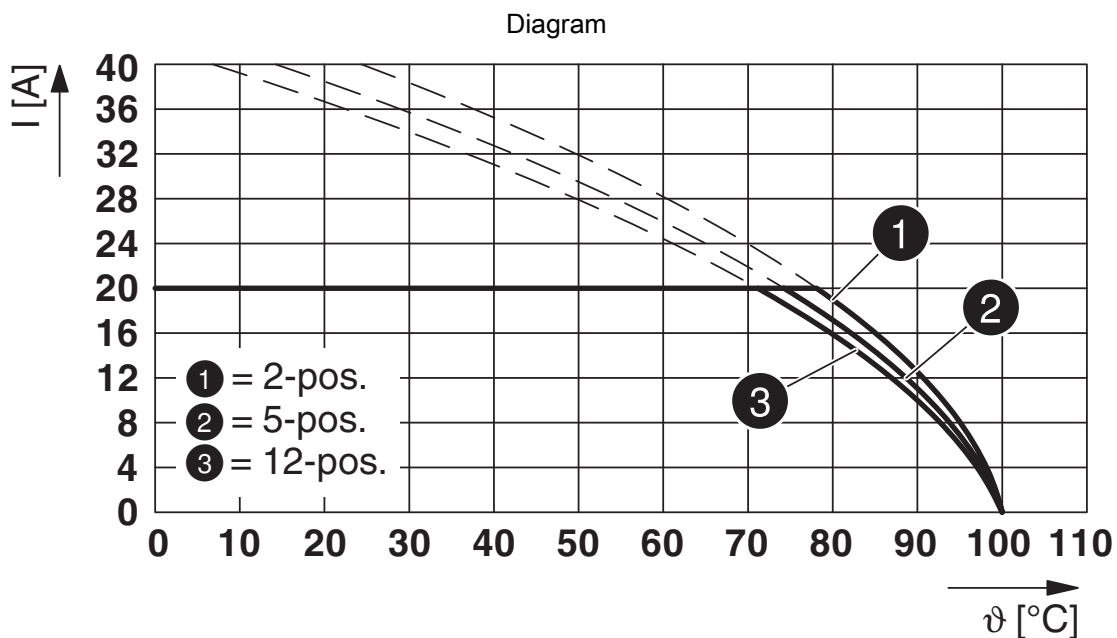

Type: PC 4/...-STF-7,62 with IPC 5/...-STGF-7,62

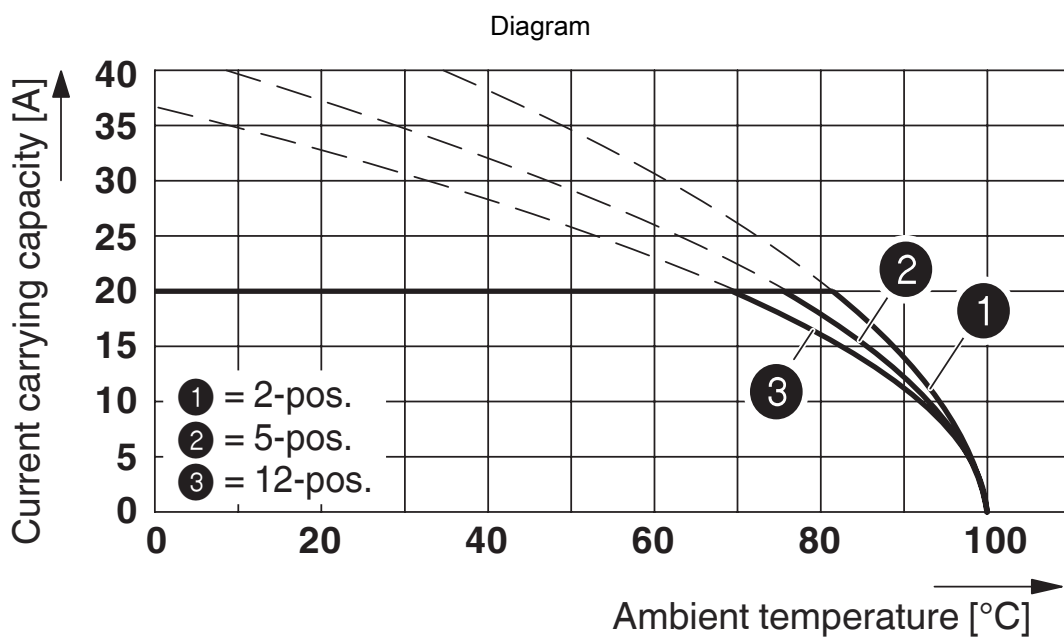

Type: PC 4/...-STF-7,62 with PC 4/...-G-7,62 and BF-PC 4



# PC 4/ 6-STF-7,62 - PCB connector

1828281

<https://www.phoenixcontact.com/in/products/1828281>

Dimensional drawing

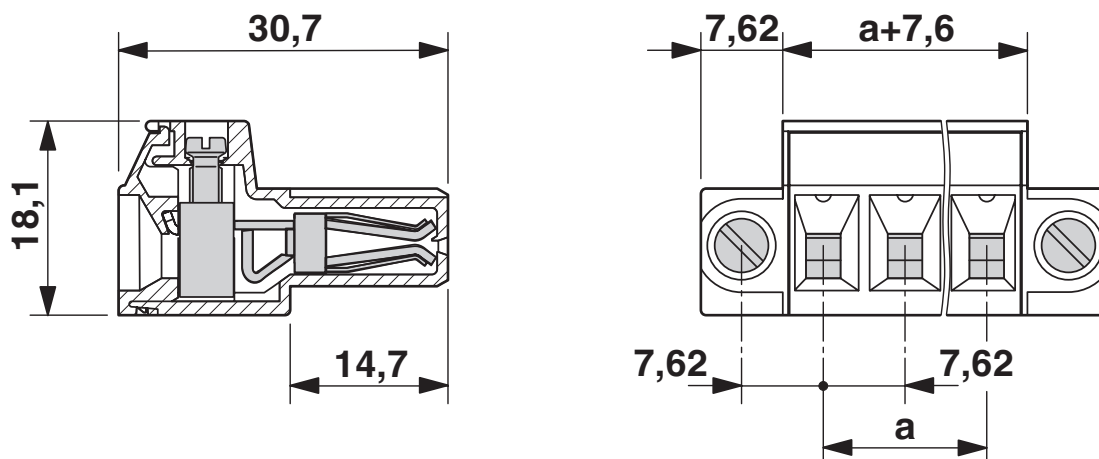

Diagram

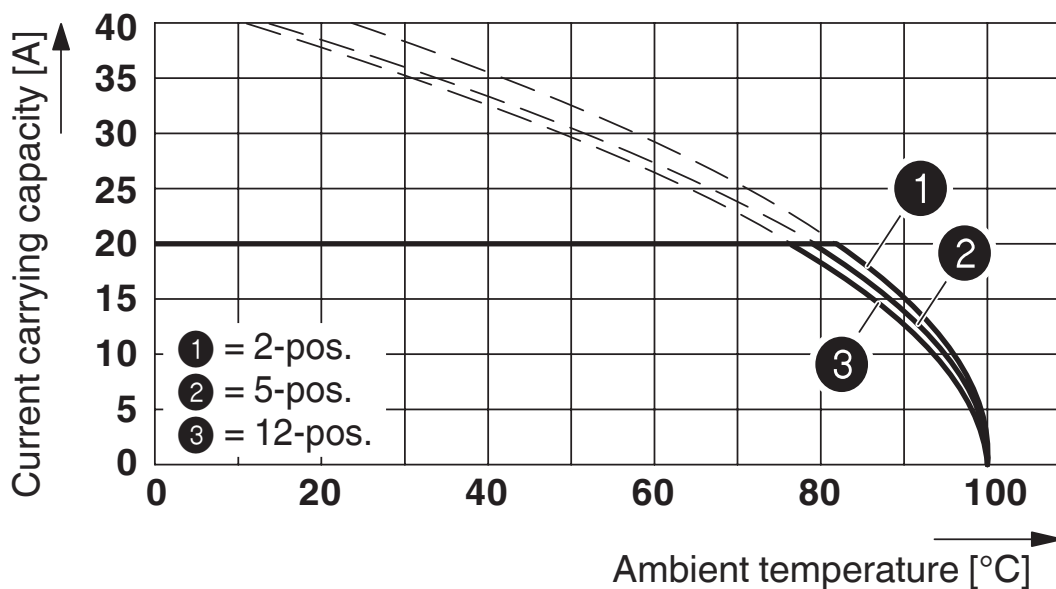

Type: PC 4/...-STF-7,62 with DFK-PC 4/...-GF-7,62

# PC 4/ 6-STF-7,62 - PCB connector



1828281

<https://www.phoenixcontact.com/in/products/1828281>

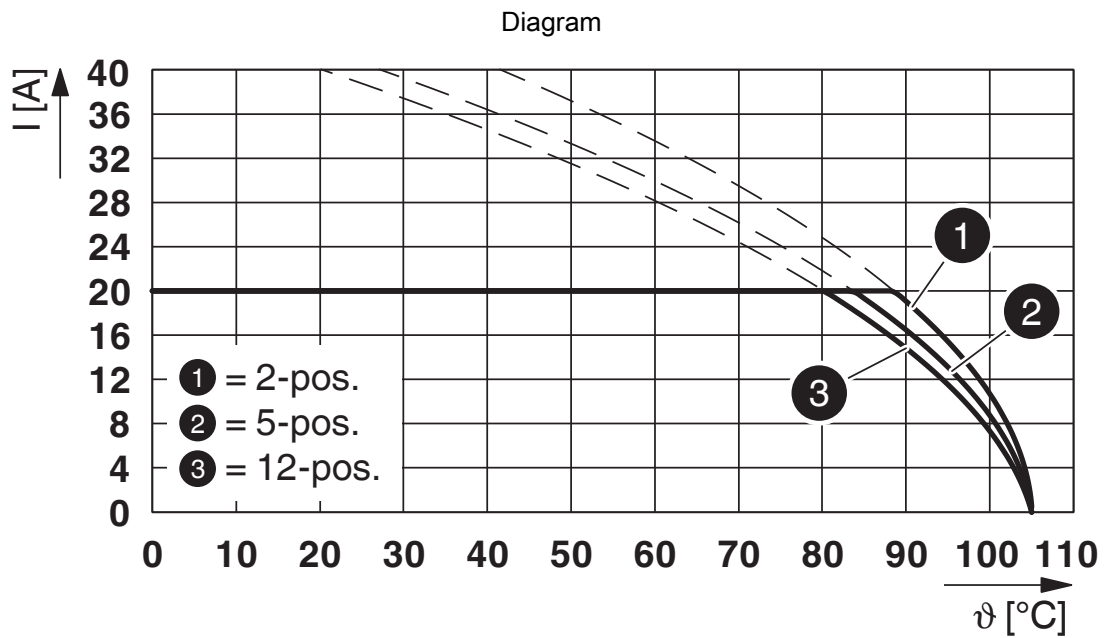

Type: PC 4/...-STF-7,62 with PC 5/...-GFU-7,62

# PC 4/ 6-STF-7,62 - PCB connector





1828281

<https://www.phoenixcontact.com/in/products/1828281>

## Approvals

 <b>CSA</b> Approval ID: 13631				
	Nominal Voltage $U_N$	Nominal Current $I_N$	Cross Section AWG	Cross Section $\text{mm}^2$
	300 V	20 A	28 - 10	-
	300 V	20 A	28 - 10	-

 <b>EAC</b> Approval ID: B.01687
--

 <b>cULus Recognized</b> Approval ID: E60425-19920722				
	Nominal Voltage $U_N$	Nominal Current $I_N$	Cross Section AWG	Cross Section $\text{mm}^2$
	300 V	30 A	30 - 10	-
	300 V	30 A	30 - 10	-
	600 V	5 A	30 - 10	-

 <b>DNV GL</b> Approval ID: TAE00001EZ
--

 <b>LR</b> Approval ID: LR21308805TA
--

 <b>BV</b> Approval ID: 35433/B0 BV
---

# PC 4/ 6-STF-7,62 - PCB connector



1828281

<https://www.phoenixcontact.com/in/products/1828281>

## Classifications

### ECLASS

ECLASS-11.0	27460202
ECLASS-12.0	27460202
ECLASS-13.0	27460202

### ETIM

ETIM 8.0	EC002638
----------	----------

### UNSPSC

UNSPSC 21.0	39121400
-------------	----------

# PC 4/ 6-STF-7,62 - PCB connector



1828281

<https://www.phoenixcontact.com/in/products/1828281>

## Environmental Product Compliance

China RoHS	Environmentally friendly use period: unlimited = EFUP-e
	No hazardous substances above threshold values

# PC 4/ 6-STF-7,62 - PCB connector

1828281

<https://www.phoenixcontact.com/in/products/1828281>

## Accessories

### CP-PC RD - Coding profile

1701967

<https://www.phoenixcontact.com/in/products/1701967>

Coding profile, for plugging into the coding ribs of the plug at a later date, insulating material, color: Red

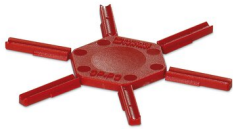

---

### SK 7,62/3,8:FORTL.ZAHLEN - Marker card

0804549

<https://www.phoenixcontact.com/in/products/0804549>

Marker card, white, labeled, horizontal: consecutive numbers 1 ... 10, 11 ... 20, etc. up to 91 ... 100, mounting type: adhesive, for terminal block width: 7.62 mm, lettering field size: 7.62 x 3.8 mm

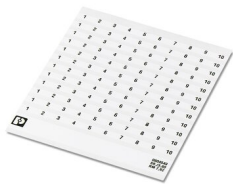

## PC 4/ 6-STF-7,62 - PCB connector

1828281

<https://www.phoenixcontact.com/in/products/1828281>



## SZS 0,6X3,5 - Screwdriver

1205053

<https://www.phoenixcontact.com/in/products/1205053>



Actuation tool, for ST terminal blocks, insulated, also suitable for use as a bladed screwdriver, size: 0.6 x 3.5 x 100 mm, 2-component grip, with non-slip grip

---

## PCVK 4-7,62 - DIN rail connector

1849998

<https://www.phoenixcontact.com/in/products/1849998>



DIN rail connector, nominal cross section: 4 mm<sup>2</sup>, color: green, nominal current: 20 A, rated voltage (III/2): 630 V, contact surface: Tin, type of contact: Pin, number of potentials: 1, number of rows: 1, number of positions: 1, number of connections: 1, product range: PCVK 4, pitch: 7.62 mm, connection method: Screw connection with tension sleeve, screw head form: L Slotted, mounting: DIN rail, conductor/PCB connection direction: 0 °, plug-in system: COMBICON PC 4, locking: without, mounting: without, type of packaging: packed in cardboard

## PC 4/ 6-STF-7,62 - PCB connector

1828281

<https://www.phoenixcontact.com/in/products/1828281>



## UPCV3K 4-G-7,62 - Feed-through terminal block

1838381

<https://www.phoenixcontact.com/in/products/1838381>



Feed-through terminal block, Current and voltage are determined by the plug used., nom. voltage: 800 V, nominal current: 20 A, number of connections: 4, number of positions: 1, connection method: Screw/plug-in connection, cross section: 0.2 mm<sup>2</sup> - 4 mm<sup>2</sup>, mounting type: NS 35/7,5, NS 35/15, NS 32, color: gray

---

## PCVK 4-7,62-PE - DIN rail connector

1876246

<https://www.phoenixcontact.com/in/products/1876246>

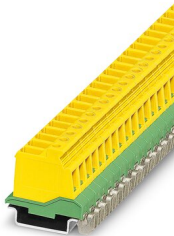

DIN rail connector, nominal cross section: 4 mm<sup>2</sup>, color: green-yellow, nominal current: 20 A, rated voltage (III/2): 630 V, contact surface: Tin, type of contact: Pin, number of potentials: 1, number of rows: 1, number of positions: 1, number of connections: 1, product range: PCVK 4-PE, pitch: 7.62 mm, connection method: Screw connection with tension sleeve, screw head form: L Slotted, mounting: DIN rail, conductor/PCB connection direction: 0 °, plug-in system: COMBICON PC 4, locking: without, mounting: without, type of packaging: packed in cardboard



# PC 4/ 6-STF-7,62 - PCB connector



1828281

<https://www.phoenixcontact.com/in/products/1828281>

## DFK-PC 4/ 6-GF-7,62 - Feed-through plug

1840599

<https://www.phoenixcontact.com/in/products/1840599>

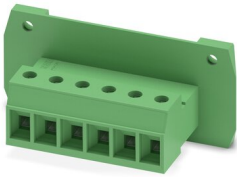

Feed-through connector, nominal cross section: 4 mm<sup>2</sup>, color: green, nominal current: 20 A, rated voltage (III/2): 630 V, contact surface: Tin, type of contact: Pin, number of potentials: 6, number of rows: 1, number of positions: 6, number of connections: 6, product range: DFK-PC 4/...-GF, pitch: 7.62 mm, connection method: Screw connection with tension sleeve, screw head form: L Slotted, mounting: Direct mounting, conductor/PCB connection direction: 0 °, number of solder pins per potential: 1, plug-in system: COMBICON PC 4, Pin connector pattern alignment: Standard, locking: Screw locking, mounting: Threaded flange, type of packaging: packed in cardboard

---

Phoenix Contact 2023 © - all rights reserved

<https://www.phoenixcontact.com>

PHOENIX CONTACT (I) Pvt. Ltd.

A-58/2, Okhla Industrial Area, Phase - II, New Delhi-110 020

+91.1275.71420

[info@phoenixcontact.co.in](mailto:info@phoenixcontact.co.in)