

Bulgin's broad line of pushbutton switches are available in various sizes and configurations. This includes a variety of illumination and terminal options as well as several with high inductive power ratings suitable for motor driven applications. These switches can be found in many markets including home appliances, commercial, medical, audio and security.

- Miniature, round and rectangular push button switches available
- Ratings up to 16A, 250V ac
12(12)A 250V ac rating also available
- Latching and momentary actions
- Choice of actuators
(custom option also available)
- Square and Round Mounting Styles



Front Panel Mounting



MP0012/Col

- 22mm diameter
- Prominent Button
- S.P. Push to Make
- Screw Terminals
- Brass, Chrome Plated Body, Glass Filled Nylon Button



Front Panel Mounting



MP0012/1/Col

- 22mm diameter
- Recessed Button
- S.P. Push to Make
- Screw Terminals
- Brass, Chrome Plated Body, Glass Filled Nylon Button



Rear Panel Mounting



MP0016

- S.P. Push to Make
- Solder Tags
- 1A, 28Vac/dc
- Brass Nickel Plated Body, Glass Filled Nylon Button



Specifications	MP0012/Colour	MP0012/1/Colour	MP0016/Colour
Terminations:	Screw Terminals	Screw Terminals	Solder Tags
Switching:	S.P. Push to Make Slow Momentary Action	S.P. Push to Make Slow Momentary Action	S.P. Push to Make Slow Momentary Action
Max. Rating:	0.25A. 250Vac, 1A. 110Vac, 2A. 12Vac/dc	0.25A. 250Vac, 1A. 110Vac, 2A. 12Vac/dc	1A 28Vac/dc (non-inductive)
Contact Resistance:	<15mΩ	<15mΩ	<15mΩ
Insulation Resistance:	>10 ⁴ MΩ	>10 ⁴ MΩ	>10 ⁴ MΩ
Dielectric Strength:	>2.5kVac	>2.5kVac	>2.0kVac
Operating Temp. Range:	-20°C to +85°C	-20°C to +85°C	-20°C to +85°C
Operation Pressure (typ):	9.18 newtons	9.18 newtons	6.22 newtons
Materials			
Moulding:	Glass Filled Nylon Brass,	Glass Filled Nylon Brass,	Glass Filled Nylon Brass,
Body:	Brass, Chrome Plated	Brass, Chrome Plated	Brass, Chrome Plated
Contacts/Terms:	Brass, Silver Plated	Brass, Silver Plated	Brass, Silver Plated
Variant	Button Colour: Standard - Black, /RD (Red)	Button Colour: Standard - Black, /RD (Red)	Button Colour: Standard - Black, /RD (Red)
RoHS	Compliant	Compliant	Compliant

8300 Series Push Button

8(8)A 250Vac & 12(12)A 250Vac



Key Features

- Miniature push button
- 8A Inductive current rating
- Ratings up to 12(12)A, 250V ac (H suffix)
- Illuminated and nonilluminated
- Single and double Contact
- Latching and momentary
- Slotted actuator for custom buttons
- Industry standard panel cutout
- Panel cut out: 19.3 x 12.9

Approvals and specifications

16(4)A 250Vac T85, 1E4 (10,000 Operations)
 12(12)A 250Vac T105, 1E4 (10,000 Operations)
 8(8)A 250Vac T105, 5E4 (50,000 Operations)
 6(6)A 250Vac T125, 5E4 (50,000 Operations)

8350, 8351, 8353, 8354
 12A 250Vac DR, 250Vac 1hp, 125Vac 1/2hp

8300, 8301, 8303, 8304
 13A 250Vac SP, 250Vac 1hp, 125Vac 1/2hp

UL 85°C, file E45221, CSA file LR10990

In house test:
10(10)A 250Vac—Indicative rating only

3mm contact gap.

Terminal	Function	Actuator	Body Code	Body Colour								
<p>C</p>	<p>1 2 3 4</p> <p>Approvals & ratings vary with function Single Contact switches use terminals 1 & 2 (& 3)</p> <p>8300 Single Contact ON - OFF</p>	<p>A Standard actuator</p>	<p>Panel cut-out ** Bezel</p> <p>B Standard body</p>	<p>B Black</p>								
<p>H</p>	<p>8301 Single Contact ON - OFF (momentary ON)</p>	<p>H Slotted for custom caps</p>	<p>E Softline style body with radiused bezel</p> <p>Cut-outs must be punched in the direction of insertion</p>	<p>W White</p>								
<p>A</p>	<p>8303 Single Contact ON - OFF With Light</p>	<p>Slots for snap-in buttons</p> <p>C Square actuator</p>	<p>F Small round actuator</p>	<p>Dimensions for snap-in fixing</p> <table border="1"> <thead> <tr> <th>Panel thickness</th> <th>Dimension X</th> </tr> </thead> <tbody> <tr> <td>0.75-1.24</td> <td>19.1/19.2</td> </tr> <tr> <td>1.25-1.99</td> <td>19.3/19.4</td> </tr> <tr> <td>2.00-3.00</td> <td>19.7/19.8</td> </tr> </tbody> </table>	Panel thickness	Dimension X	0.75-1.24	19.1/19.2	1.25-1.99	19.3/19.4	2.00-3.00	19.7/19.8
Panel thickness	Dimension X											
0.75-1.24	19.1/19.2											
1.25-1.99	19.3/19.4											
2.00-3.00	19.7/19.8											
<p>K</p>	<p>8304 Single Contact ON - OFF (momentary ON) with light</p>	<p>E Radiused actuator</p>	<p>J Smooth curved actuator</p>	<p>X and V PCB terminals. Additional dummy terminals may be supplied for extra support.</p>								
<p>T</p>	<p>8350 Double Contact ON - OFF</p>	<p>F Small round actuator</p>	<p>M</p>									
<p>X</p>	<p>8351 Double Contact ON - OFF (momentary ON)</p>	<p>J Smooth curved actuator</p>	<p>D Large round actuator</p>									
<p>V</p>	<p>8353 Double Contact ON - OFF With light</p>	<p>M</p>										
<p>X</p>	<p>8354 Double Contact ON - OFF (momentary ON) with light</p>	<p>D Large round actuator</p>										
<p>V</p>	<p>8355 Single Contact ON - OFF Isolated light - switched C, E & M actuators only</p>	<p>M</p>										
<p>X</p>	<p>8356 Single Contact ON - OFF Isolated light - unswitched C, E & M actuators only</p>	<p>All actuators except H available lit</p>										

Dimensions

Actuator A
Body B

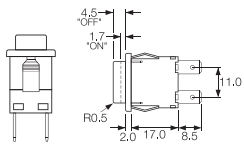

Actuator J
Body E

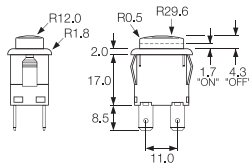

Examples



H8350AB ---
T8350AB ---



H8353JE ---
T8353JE ---



H8353EB ---
T8353EB ---



H8353CB ---
T8353CB ---

Actuator Colour	Lamp Voltage	Legend	Legend Colour	Options
LIT				
A Amber	— None			<p>H 12(12)A 250Vac switch rating</p> <p>Finish Matt finish standard except on J and D actuators which are gloss</p> <p>Colour Call sales for custom colours A full range is available for large orders</p> <p>Legend printing Select from the examples or call sales for custom legends.</p> <p>Special buttons Some of the many options are shown Call sales for the full range</p> <p>L167 Protective cover</p>  <p>Snaps on to switch bodies fitted with "A" or "J" style actuators, this reduces panel thickness by 0.8mm</p> <p>BioCote Antimicrobial Additive Moulded components have antimicrobial properties using BioCote silver ion technology.</p>
C Clear	2 125V Neon			
G Green	3 250V Neon			
R Red	7 12V Filament			
UNLIT	8 24V Filament			
B Black				
R Red				
W White				

8200 Series Push Button

8(8)A 250Vac & 12(12)A 250Vac



Key Features

- ⬡ Miniature push button
- ⬡ 8A Inductive current rating
- ⬡ Ratings up to 12(12)A, 250V ac (H suffix)
- ⬡ Without button
- ⬡ Sub panel mount
- ⬡ Push on, solder or PCB terminals
- ⬡ Latching and momentary

Approvals and specifications

- ⚡ 16(4)A 250Vac T85, 1E4 (10,000 Operations)
- 12(12)A 250Vac T105, 1E4 (10,000 Operations)
- 8(8)A 250Vac T105, 5E4 (50,000 Operations)
- 6(6)A 250Vac T125, 5E4 (50,000 Operations)

12A 250Vac
250Vac 1hp, 125Vac 1/2hp
 UL 85°C, file E45221, CSA file LR10990

3mm contact gap.

Terminal	Function	Actuator	Body Code
<p>C</p> <p>6.3 x 0.8 10.1</p>	<p>1 2 3 4</p> <p>Approvals & ratings vary with function Single Contact switches use terminals 1 & 2 (& 3)</p> <p>8200 Single Contact ON - OFF</p>	<p>A</p> <p>Standard actuator for snap-on custom adaptors</p> <p>B</p> <p>Flat top actuator</p> <p>C</p> <p>Curved top actuator</p> <p>Examples of possible actuation methods</p> <p>Using a Snap on adaptor</p> <p>Using a Hinged Actuator</p>	<p>A</p> <p>Standard body</p> <p>See dimensioned drawings for details</p> <p>C</p> <p>As standard body but with side support peg for use with M PCB terminals</p> <p>X and V PCB terminals. Additional dummy terminals may be supplied for extra support.</p>
<p>H</p> <p>4.8 x 0.8 8.5</p> <p>A</p> <p>7.6 As "H" but right angle 4.8 x 0.8</p>	<p>8201 Single Contact ON - OFF (momentary ON)</p>	<p>C</p> <p>2.6 1.5 8.5 2.8 x 0.8</p>	<p>C</p> <p>As standard body but with side support peg for use with M PCB terminals</p> <p>X and V PCB terminals. Additional dummy terminals may be supplied for extra support.</p>
<p>T</p> <p>2.6 1.5 7.0 Solder</p> <p>V</p> <p>3.7 Ctrs 4.3 Dual Plug PCB (Call sales for mounting dims)</p>	<p>8250 Double Contact ON - OFF</p>	<p>C</p> <p>2.6 1.5 7.0 Solder</p> <p>V</p> <p>3.7 Ctrs 4.3 Dual Plug PCB (Call sales for mounting dims)</p>	<p>C</p> <p>As standard body but with side support peg for use with M PCB terminals</p> <p>X and V PCB terminals. Additional dummy terminals may be supplied for extra support.</p>
<p>X</p> <p>4.5 7.0 PCB 0.8 Sq</p>	<p>8251 Double Contact ON - OFF (momentary ON)</p>	<p>C</p> <p>2.6 1.5 7.0 Solder</p> <p>V</p> <p>3.7 Ctrs 4.3 Dual Plug PCB (Call sales for mounting dims)</p>	<p>C</p> <p>As standard body but with side support peg for use with M PCB terminals</p> <p>X and V PCB terminals. Additional dummy terminals may be supplied for extra support.</p>

Dimensions

'A' body with 'H' 4.8 terminals

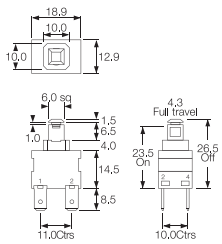

Example of possible mounting styles



'A' body with 'A' right angle 4.8 terminals

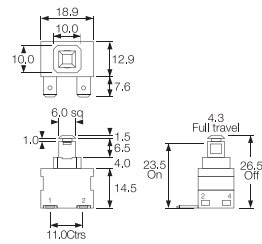

Alternative Actuator



Impact washer resists damage from excessive operator force

'C' body with 'M' right angle PCB terminals

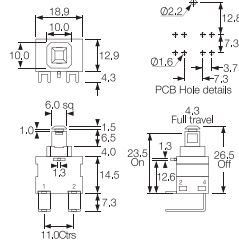

Examples



C8250AA ---
with impact
washer M1226



X8201AA ---



K8200AA ---



A8200AA ---



M8200AC ---



Example of M8200AC

7000 Series Push Button

16A 250Vac















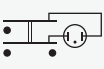
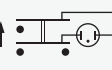

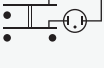
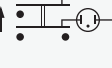
Key Features

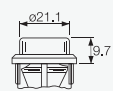
- Round and rectangular push button switches
- Ratings up to 16A, 250V ac
- Latching and momentary
- Illuminated & non-illuminated
- Matching indicators
- Low profile version
- Panel cut outs: 25.0 dia 27.2 x 22.3

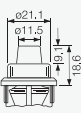
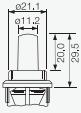
Approvals and specifications

- CE 16(4)A 250Vac T125
8(8)A 250Vac T85
- UL CSA 16A Non Ind, 250Vac 1hp, 125Vac 1/2hp
UL 65°C, file no. E45221, CSA file no. LR10990
- 3mm contact gap.

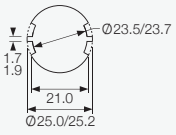
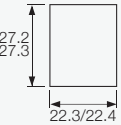
Terminal	Function	Actuator	Body Code
<p>C</p>  <p>6.3 x 0.8</p> <p>H</p>  <p>4.8 x 0.8</p>	<p>1 2 3 4 Approvals & ratings vary with function Single Contact switches use terminals 1 & 2 (& 3)</p> <p>7000 Single Contact ON - OFF</p>  <p>7001 Single Contact (momentary) ON - OFF</p>  <p>7003 Single Contact (with light) ON - OFF</p>  <p>7004 Single Contact (momentary) with light ON - OFF</p>  <p>7050 Double Contact ON - OFF</p>  <p>7051 Double Contact with light ON - OFF</p>  <p>7053 Double Contact with light ON - OFF</p>  <p>7054 Double Contact (momentary ON) with light ON - OFF</p>  <p>7030 Indicator UL E63363 CSA LR29381</p> 	<p>A Round actuator shown in F body</p>  <p>A Round actuator shown in G body</p>  <p>B Round actuator - medium shown in F body</p>  <p>C Round actuator - long shown in F body</p>  <p>D Round actuator - sub panel mount</p>  <p>S Rectangular actuator Shown in "A" body N/A for 7030</p> 	<p>Panel cut-outs</p> <p>F H G</p> <p>Body types fit either cut-out</p>  <p>25.0/25.2</p>  <p>Ø23.5/23.7 21.0 Ø25.0/25.2</p> <p>A</p>  <p>27.2 27.3 22.3/22.4</p> <p>Cut-outs must be punched in the direction of insertion</p>

Dimensions

Panel thickness:

A - 0.8 - 2.5mm

F, G, H - 0.8 - 5.0mm

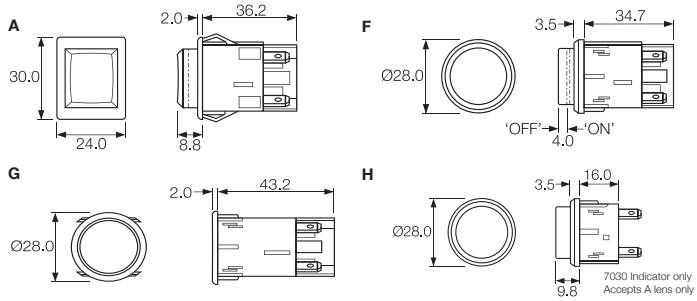

Examples



C7000AF ---



C7003AF ---



C7050SA ---



C7053AG ---

Body Colour	Actuator Colour	Lamp Voltage	Legend	Legend Colour	Options
B Black	A Amber	— None			<p>Finish Matt finish is standard on bodies. Gloss finish is standard on actuators.</p> <p>Colour Call sales for custom colours. A full range is available for large orders.</p> <p>Legend printing A wide range is available or call sales for custom legends.</p> <p>Lamp voltage Call sales for details of available voltages.</p> <p>Weatherproof housing (E) Additional housing which fits round body switches with an oversize housing with a clear silicone cover designed to IP65. Mounting hole dia: 38.0mm</p>
W White	C Clear	2 125V Neon			
	G Green	3 250V Neon			
	R Red	7 12V Filament			
		8 24V Filament			
	B Black	UNLIT			
	R Red				
	W White				

0911 Push Button Switches

0.5A 250Vac



Key Features

- Snap action switches
- Ratings up to 16A, 250Vac
- Round and rectangular buttons

Approvals and specifications

- ⚡ 16(4)A 250Vac 5E4 T85
 - ⚡ 16A 125/250Vac 3/4hp T85 50E3
125V 1/2 HP, 250V 3/4 HP, 0.4A 125Vdc, 0.2A 250Vdc
- Approvals apply to switch mechanism only.
μ contact gap.

Dimensions

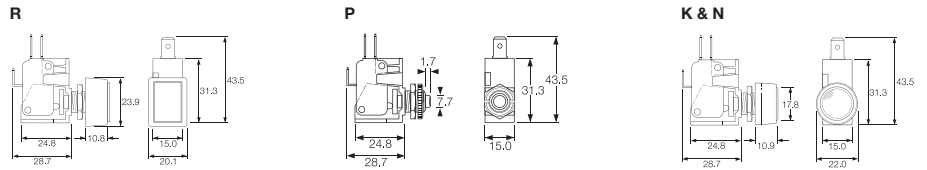

Terminal	Function	Actuator	Body Code	Options
	<p>0911 (momentary) ON - ON</p>	<p>R Rectangular bezel</p> <p>P Short</p> <p>K with satin chrome bezel</p> <p>N with nylon bezel</p>	<p>Panel Cut-out</p> <p>Panel thickness Both nuts 2.5mm No backnut 4.0mm</p>	<p>Call factory for custom colours</p>



Key Features

- Self wiping contacts
- Slow make & break
- Momentary action
- Choice of switch circuits
- Choice of actuators

Approvals and specifications

In house test:
0.5A 250Vac T85 – Indicative rating only

Dimensions

Dimensions (mm) Nylon S and L actuators



Neck thread - 40 TPI Whit. Actuator travel - 2.5 max

Stainless steel V actuator (IP66)



Neck thread - 26 TPI Whit. Actuator travel - 2.5 max

Terminal	Function	Actuator	Body Code	Options
<p>T</p>	<p>0916</p> <p>Black base SP ON - OFF (momentary)</p>	<p>S Small Actuator</p>	<p>Panel Cut-out (L & S Actuators)</p>	<p>Finish</p> <p>Gloss finish for L and S actuators.</p>
	<p>0917 50V only</p> <p>Brown base SP ON - OFF (momentary 1 side)</p>	<p>L Large Actuator</p>	<p>Panel thickness Both nuts - 2.5mm No Backnut - 4.0</p>	<p>Colour</p> <p>Call sales for custom colours. A full range is available for large orders.</p>
	<p>0918</p> <p>White base SP ON - OFF (momentary OFF)</p>	<p>V Vandal Resistant IP66 Flattop Stainless Steel</p>	<p>Panel Cut-out (Stainless Steel V Actuator) Panel thickness - 8.0mm</p>	
	<p>0919</p> <p>Black base DP ON - OFF (momentary 1 side)</p>			
	<p>0920</p> <p>White base DP ON - OFF (momentary ON)</p>			