

SAC-3P-MS/ 0,6-PUR/A-1L-Z SCO - Sensor/actuator cable



1434895

<https://www.phoenixcontact.com/in/products/1434895>

Please be informed that the data shown in this PDF document is generated from our Online Catalog. Please find the complete data in the user documentation. Our General Terms of Use for Downloads are valid.



Sensor/actuator cable, 3-position, PUR halogen-free, black-gray RAL 7021, Plug straight M12 SPEEDCON, coding: A, on Valve connector A, with 1 LED, connected with Z diode, cable length: 0.6 m

Your advantages

- Easy and safe: 100% electrically tested plug-in components
- Save time, thanks to installation with SPEEDCON fast locking system
- Convenient: increased machine availability thanks to quick and easy diagnostics
- Our standard: robust halogen-free PUR cable

Commercial Data

Item number	1434895
Packing unit	1 pc
Minimum order quantity	1 pc
Sales Key	BF1
Product Key	BF1DJA
Catalog Page	Page 228 (C-2-2019)
GTIN	4046356413299
Weight per Piece (including packing)	54.22 g
Weight per Piece (excluding packing)	50.3 g
Customs tariff number	85444290
Country of origin	PL

SAC-3P-MS/ 0,6-PUR/A-1L-Z SCO - Sensor/actuator cable



1434895

<https://www.phoenixcontact.com/in/products/1434895>

Technical Data

Product properties

Product type	Sensor/actuator cable with valve connector
Number of positions	3
Application	Standard
No. of cable outlets	1
Shielded	no
Coding	A

Insulation characteristics

Overvoltage category	III
Degree of pollution	3

Material specifications

Flammability rating according to UL 94	HB
Seal material	TPU
Material housing valve plug	TPU
Material of grip body	TPU
Contact material	CuSn
Contact surface material	Ni/Au
Contact carrier material	TPU GF
Contact material	CuSn
Valve plug contact insert material	PA 6.6
Contact surface material	Sn
Material for screw connection	Zinc die-cast, nickel-plated

Electrical properties

Contact resistance	$\leq 5 \text{ m}\Omega$
Insulation resistance	$\geq 100 \text{ M}\Omega$
Nominal voltage U_N	24 V AC
	24 V DC
Nominal current I_N	4 A
Protective circuit	Z diode

Valve connector characteristics

Fixing screws	M3 x 29
Pulse power	40 W (at 100 μs square-wave pulse)
Terminal voltage	70 V (at 2 mA constant current)
Reverse voltage	50 V

Mechanical properties

Mechanical data

Insertion/withdrawal cycles	≥ 100 (M12 connector)
-----------------------------	----------------------------

SAC-3P-MS/ 0,6-PUR/A-1L-Z SCO - Sensor/actuator cable

1434895

<https://www.phoenixcontact.com/in/products/1434895>

Signaling

Status display	1 LED
Status display present	Yes

Connector

Connection 1

Coding type	A
-------------	---

Connection 2

Material	CuSn (Contact)
	Sn (Contact surface)
	PA 6.6 (Contact carriers)
	TPU (Housing)

Cable/line

Cable length	0.6 m
--------------	-------

PUR halogen-free black [PUR]

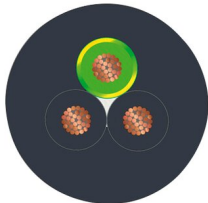
Dimensional drawing	
Cable weight	30 kg/km
UL AWM Style	20549
Number of positions	3
Shielded	no
Cable type	PUR halogen-free black [PUR]
Conductor structure signal line	28x 0.15 mm
AWG signal line	20
Conductor cross section	3x 0.5 mm ²
Wire diameter incl. insulation	1.5 mm ±0.05 mm (Signal line)
External cable diameter	4.5 mm ±0.2 mm
Outer sheath, material	PUR
External sheath, color	black-gray RAL 7021
Conductor material	Bare Cu litz wires
Material wire insulation	PP
Single wire, color	black 1, black 2, green/yellow
Overall twist	3 wires, twisted
Max. conductor resistance	39 Ω/km (at 20 °C)
Insulation resistance	min. 20 MΩ*km

SAC-3P-MS/ 0,6-PUR/A-1L-Z SCO - Sensor/actuator cable



1434895

<https://www.phoenixcontact.com/in/products/1434895>

Nominal voltage, cable	≤ 300 V
Test voltage	≥ 1200 V
Minimum bending radius, fixed installation	5 x D
Minimum bending radius, flexible installation	10 x D
Smallest bending radius, fixed installation	22.5 mm
Max. bending cycles	15000000
Halogen-free	in accordance with DIN VDE 0472 part 815
Flame resistance	according to DIN VDE 0482 According to DIN EN 50265-2-1
Resistance to oil	in accordance with DIN EN 60811-2-1
Other resistance	largely oil-resistant partly UV-resistant in accordance with DIN EN ISO 4892-2-A
Ambient temperature (operation)	-40 °C ... 80 °C (cable, fixed installation) -20 °C ... 80 °C (Cable, flexible installation)

Environmental and real-life conditions

Ambient conditions

Degree of protection	IP65 IP67
Ambient temperature (operation)	-25 °C ... 90 °C (Plug / socket) -20 °C ... 85 °C (valve plug) -40 °C ... 80 °C (cable, fixed installation) -15 °C ... 80 °C (Cable, flexible installation)

Standards and regulations

Standards/specifications	IEC 61076-2-101
Standards/specifications	EN 175301-803

SAC-3P-MS/ 0,6-PUR/A-1L-Z SCO - Sensor/actuator cable

1434895

<https://www.phoenixcontact.com/in/products/1434895>

Drawings

Dimensional drawing

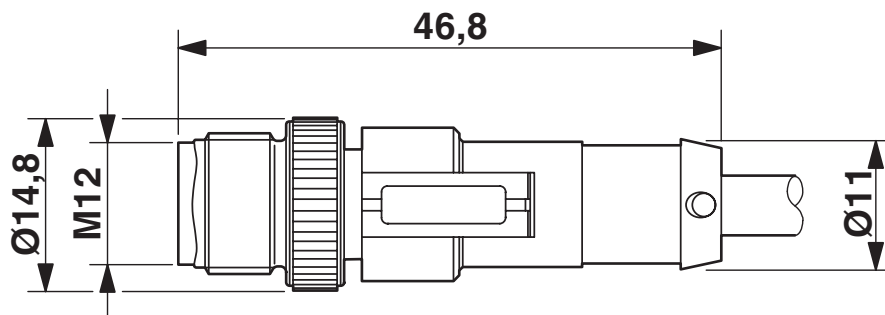

Plug, M12 x 1, straight, shielded

Circuit diagram

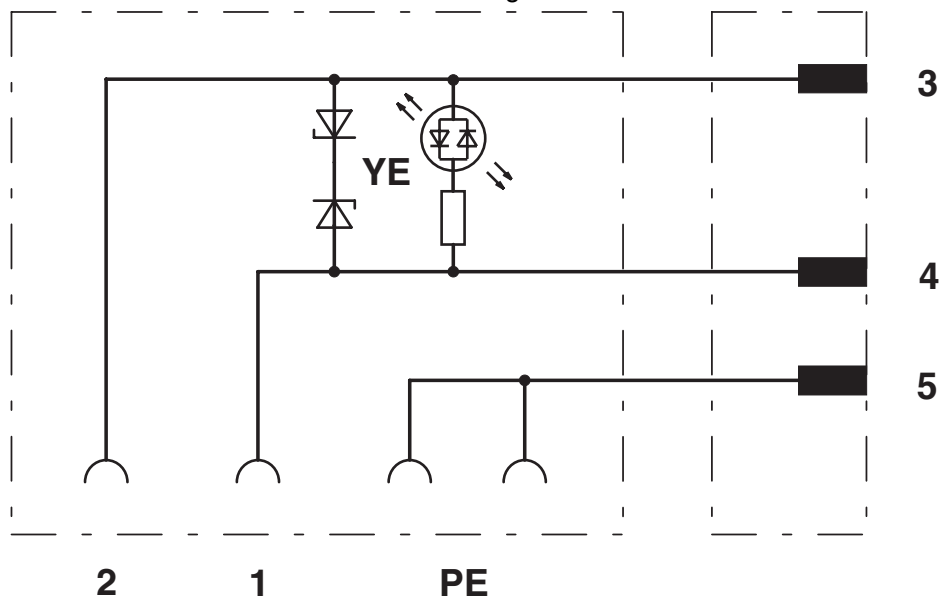

SAC-3P-MS/ 0,6-PUR/A-1L-Z SCO - Sensor/actuator cable

1434895

<https://www.phoenixcontact.com/in/products/1434895>

Schematic diagram

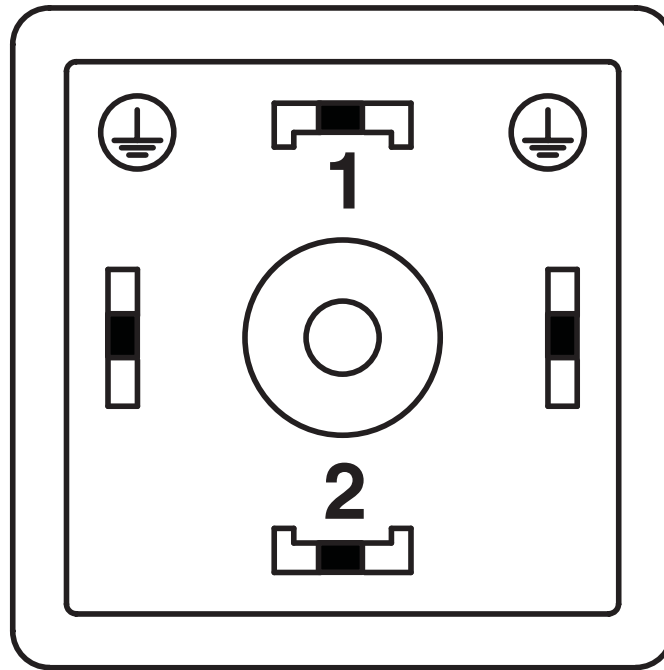

Valve connector pin assignment, type A

Dimensional drawing

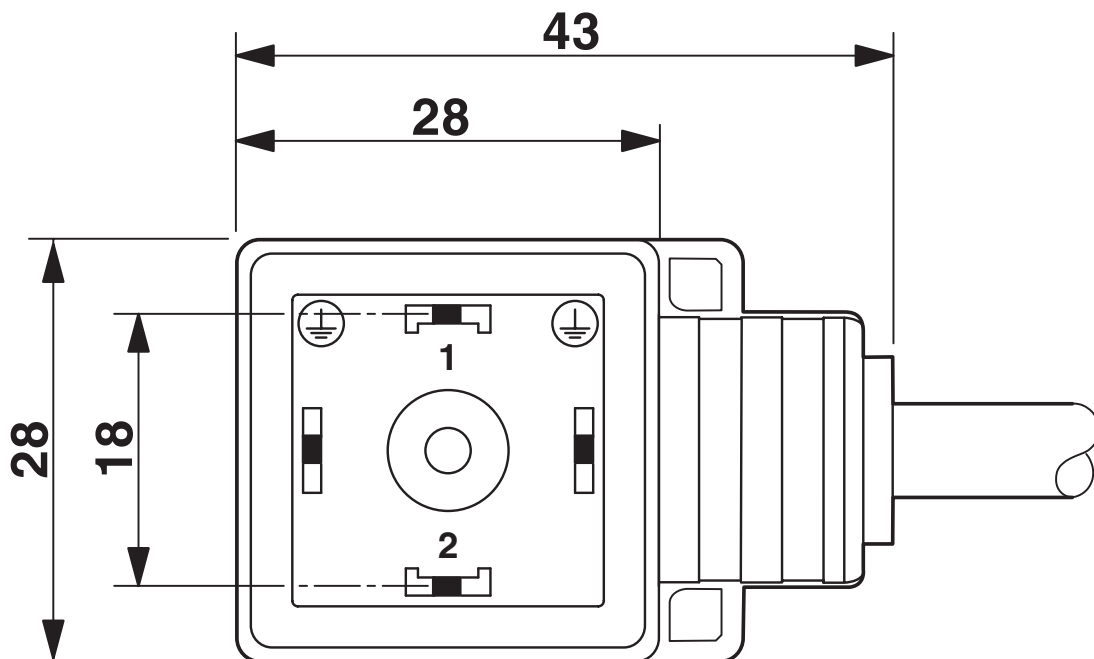

Valve connector, type A

SAC-3P-MS/ 0,6-PUR/A-1L-Z SCO - Sensor/actuator cable

1434895

<https://www.phoenixcontact.com/in/products/1434895>

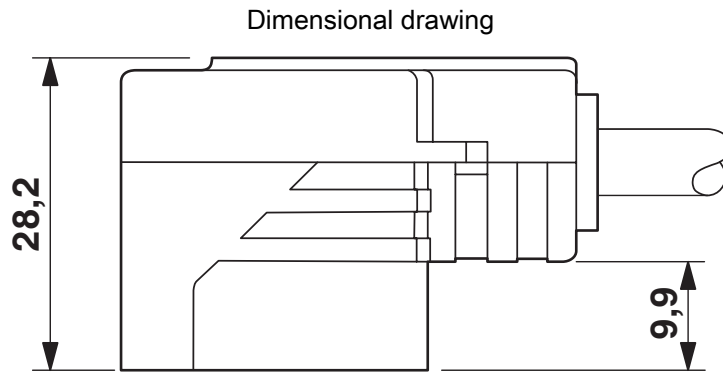

Valve connector, type A, side view

Schematic diagram

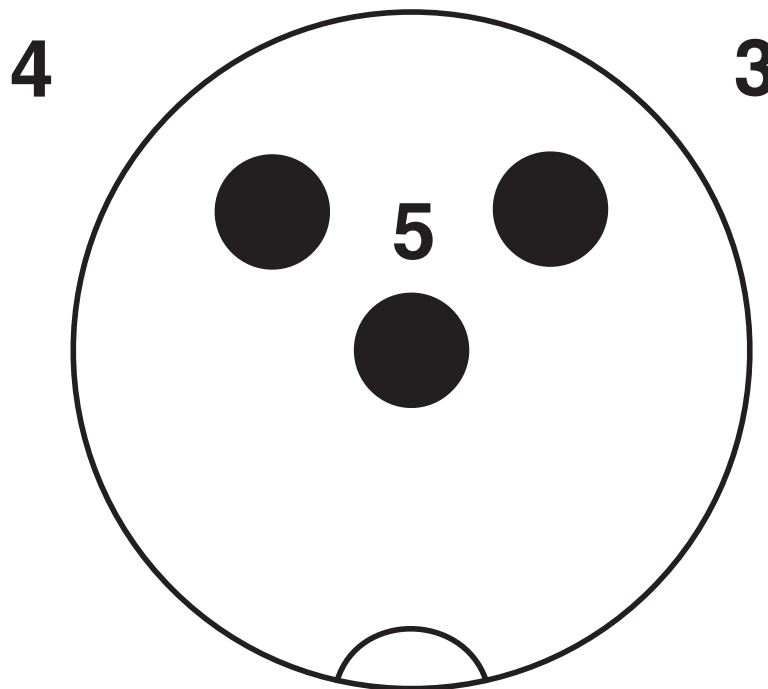

Pin assignment M12 plug, 3-pos., valve connector

SAC-3P-MS/ 0,6-PUR/A-1L-Z SCO - Sensor/actuator cable





1434895

<https://www.phoenixcontact.com/in/products/1434895>

Approvals

 CSA Approval ID: 13631				
	Nominal Voltage U_N	Nominal Current I_N	Cross Section AWG	Cross Section mm^2
	24 V	4 A	-	-

 EAC Approval ID: RU C-DE.BL08.B.00286				
---	--	--	--	--

 EAC Approval ID: RU D-DE.HB35.B.00387				
---	--	--	--	--

 CSAus Approval ID: 13631				
	Nominal Voltage U_N	Nominal Current I_N	Cross Section AWG	Cross Section mm^2
	24 V	4 A	-	-

SAC-3P-MS/ 0,6-PUR/A-1L-Z SCO - Sensor/actuator cable



1434895

<https://www.phoenixcontact.com/in/products/1434895>

Classifications

ECLASS

ECLASS-11.0	27060312
ECLASS-12.0	27060312
ECLASS-13.0	27060312

ETIM

ETIM 8.0	EC001855
----------	----------

UNSPSC

UNSPSC 21.0	31251500
-------------	----------

SAC-3P-MS/ 0,6-PUR/A-1L-Z SCO - Sensor/actuator cable



1434895

<https://www.phoenixcontact.com/in/products/1434895>

Environmental Product Compliance

China RoHS	Environmentally Friendly Use Period = 50 years For information on hazardous substances, refer to the manufacturer's declaration available under "Downloads"
------------	--

SAC-3P-MS/ 0,6-PUR/A-1L-Z SCO - Sensor/actuator cable



1434895

<https://www.phoenixcontact.com/in/products/1434895>

Accessories

SAC-V-SCREW-M3-29 KNURL - Screw

1403779

<https://www.phoenixcontact.com/in/products/1403779>



Fillister head screw with plastic knurl, M3 x 40

SF-BIT-PH 1-70 - Screw insert

1212582

<https://www.phoenixcontact.com/in/products/1212582>



Screw bit, PH crosshead, E6.3-1/4" drive, size: PH 1 x 70 mm, hardened, suitable for holder according to DIN 3126-F6.3/ISO 1173

SAC-3P-MS/ 0,6-PUR/A-1L-Z SCO - Sensor/actuator cable



1434895

<https://www.phoenixcontact.com/in/products/1434895>

PROT-M12 FS-PA-CHAIN - Sealing cap

1430873

<https://www.phoenixcontact.com/in/products/1430873>

M12 sealing cap made of plastic with fixing band, for sensor cables, for free M12 plugs



SAC-M12-EXCLIP-M - Locking clip

1558988

<https://www.phoenixcontact.com/in/products/1558988>

Locking clip for the pin side of sensor/actuator cables with M12 connector and M12 connectors for assembly, for knurl diameter: 15 mm or for Allen key with a wrench size of 14 mm, prevents the disconnection of plug-in connections without tools



SAC-3P-MS/ 0,6-PUR/A-1L-Z SCO - Sensor/actuator cable



1434895

<https://www.phoenixcontact.com/in/products/1434895>

PABA WH/23 - Insert label

1013779

<https://www.phoenixcontact.com/in/products/1013779>



Insert label, Strip, white, unlabeled, can be labeled with: CMS-P1-PLOTTER, mounting type: slide-on, cable diameter range: 1.5 ... 35 mm, lettering field size: 23 x 4 mm, Number of individual labels: 20

PABA YE/23 - Insert label

1013782

<https://www.phoenixcontact.com/in/products/1013782>



Insert label, Strip, yellow, unlabeled, can be labeled with: CMS-P1-PLOTTER, mounting type: slide-on, cable diameter range: 1.5 ... 35 mm, lettering field size: 23 x 4 mm, Number of individual labels: 20

SAC-3P-MS/ 0,6-PUR/A-1L-Z SCO - Sensor/actuator cable



1434895

<https://www.phoenixcontact.com/in/products/1434895>

B-STIFT - Marker pen

1051993

<https://www.phoenixcontact.com/in/products/1051993>



Marker pen, for manual labeling of unprinted Zack strips, smear-proof and waterproof, line thickness 0.5 mm

TSD 04 SAC - Torque screwdriver

1208429

<https://www.phoenixcontact.com/in/products/1208429>



Torque screwdriver, with preset torque of 0.4 Nm and 4 mm hexagonal drive for M12 connectors

SAC-3P-MS/ 0,6-PUR/A-1L-Z SCO - Sensor/actuator cable



1434895

<https://www.phoenixcontact.com/in/products/1434895>

TSD-M 1,2NM - Torque screwdriver

1212224

<https://www.phoenixcontact.com/in/products/1212224>



Torque screw driver, accuracy as per EN ISO 6789 standard, adjustable from 0.3 - 1.2 Nm

TSD-M SAC-BIT ADAPTER - Adapter insert

1212600

<https://www.phoenixcontact.com/in/products/1212600>



Adapter bit for TSD-M...torque tools, E6.3-1/4" drive with 4 mm hexagon to accommodate SAC bits

SAC-3P-MS/ 0,6-PUR/A-1L-Z SCO - Sensor/actuator cable



1434895

<https://www.phoenixcontact.com/in/products/1434895>

SAC BIT M12-D15 - Tool

1208432

<https://www.phoenixcontact.com/in/products/1208432>



Nut for assembling sensor/actuator cables with M12 connector and M12 connectors for assembly, with a knurl diameter of 15 mm, for 4 mm hexagonal drive

Phoenix Contact 2023 © - all rights reserved

<https://www.phoenixcontact.com>

PHOENIX CONTACT (I) Pvt. Ltd.

A-58/2, Okhla Industrial Area, Phase - II, New Delhi-110 020

+91.1275.71420

info@phoenixcontact.co.in