

Product data sheet

Specifications



battery control module - 24..28.8 V DC - 24 V - 20 A - for regulated SMPS

ABL8BBU24200

Main

Range of product	Phaseo
Product or component type	Battery control module
Input voltage	24...28.8 V DC
Output voltage	(U _{battery} -0.5) V in battery mode DC (U _{in} -0.25) V in nominal mode DC
Maximum output current	20 A

Complementary

Input voltage limits	22...30 V
Maximum power dissipation in W	7 W
Activation threshold	Adjustable 22...36 V
Number of output channels	1
Current consumption	0.6 A on load 0.1 mA no load <= 40.6 A
Output protection type	Against overload, protection technology: 1.5 x I _n Against short-circuits, protection technology: battery-backed mode, automatic reset Against short-circuits, protection technology: power-supplied mode
Connections - terminals	For diagnostic relay: removable screw terminal block, connection capacity: 1 x 0.75 mm ² For input connection: screw type terminals, connection capacity: 2 x 0.5...2 x 10 mm ² AWG 20...AWG 8 For output connection: screw type terminals, connection capacity: 2 x 0.5...2 x 10 mm ² AWG 20...AWG 8
Fixing mode	By clips on 35 mm symmetrical DIN rail, operating position: horizontal By clips on 35 mm symmetrical DIN rail, operating position: vertical
Operating altitude	2000 m
Marking	CE
Name of test	Electrostatic discharges conforming to EN/IEC 61000-4-2 Emission conforming to EN 61000-6-3 Induced electromagnetic field conforming to EN/IEC 61000-4-6 level 3 Radiated electromagnetic field conforming to EN/IEC 61000-4-3 level 3 Rapid transient conforming to IEC 61000-4-4 level 3 Surge conforming to EN/IEC 61000-4-5 level 2 Conducted/radiated emissions conforming to EN 55022 class B, 20 %
Local signalling	1 C/O relay for alarm status 1 C/O relay for battery status 1 C/O relay for power supply status LCD screen for module status
Width	60 mm
Height	125 mm

Depth	160 mm
Net weight	0.5 kg
Environment	
Product certifications	RCM EAC
Standards	UL 508 CSA C22.2 No 60950-1
Ambient air temperature for operation	-25...60 °C
Ambient air temperature for storage	-40...85 °C
Environmental characteristic	EMC conforming to EN 61000-6-3 EMC conforming to EN/IEC 61000-6-2 Safety conforming to EN/IEC 60950-1 Safety conforming to EN/IEC 61204-3
IP degree of protection	IP20 conforming to EN/IEC 60529
Dielectric strength	500 V between input and ground 500 V between output and ground
Overtoltage category	Class II conforming to VDE 0106-1
Relative humidity	0...90 % during operation 0...95 % during storage
MTBF reliability	718708 H at 24 V DC with UTE C80-810 calculation method
Vibration resistance	2 gn (f= 11.9...150 Hz) conforming to EN/IEC 61131-2 3.5 mm (f= 3...11.9 Hz) conforming to EN/IEC 61131-2

Packing Units

Unit Type of Package 1	PCE
Number of Units in Package 1	1
Package 1 Height	9 cm
Package 1 Width	19.5 cm
Package 1 Length	19.5 cm
Package 1 Weight	1.468 kg
Unit Type of Package 2	S03
Number of Units in Package 2	8
Package 2 Height	30 cm
Package 2 Width	30 cm
Package 2 Length	40 cm
Package 2 Weight	11.929 kg
Unit Type of Package 3	P06
Number of Units in Package 3	72
Package 3 Height	80 cm
Package 3 Width	80 cm
Package 3 Length	60 cm
Package 3 Weight	118.7 kg

Offer Sustainability

Sustainable offer status	Green Premium product
REACH Regulation	REACH Declaration

REACH free of SVHC	Yes
EU RoHS Directive	Pro-active compliance (Product out of EU RoHS legal scope) EU RoHS Declaration
Mercury free	Yes
China RoHS Regulation	China RoHS declaration
RoHS exemption information	Yes
Environmental Disclosure	Product Environmental Profile
Circularity Profile	End of Life Information
PVC free	Yes
California proposition 65	WARNING: This product can expose you to chemicals including: Lead and lead compounds, which is known to the State of California to cause cancer and birth defects or other reproductive harm. For more information go to www.P65Warnings.ca.gov

Contractual warranty

Warranty	18 months
-----------------	-----------

24 Vdc/20 A Battery Control Module

Dimensions

mm
inch

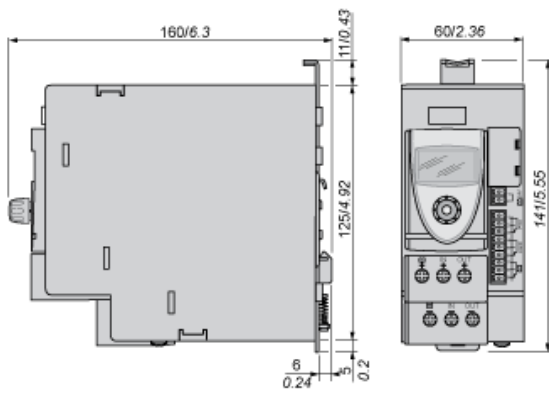

24 Vdc Battery Control Module

Mounting

mm
inch

AM1 DE200
IEC/EN 60715

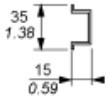

AM1 ED200

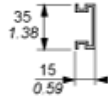

AM1 DP200

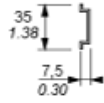

DZ5 MB200



24 Vdc Battery Control Module

Clearance

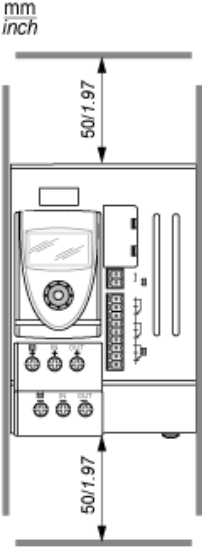

24 Vdc Battery Control Module

Wiring Diagram

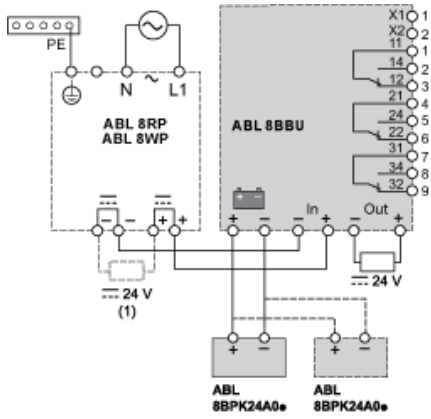







(1) See table below for the maximum unstored charge capacity (μF)



ABL	Max. Unstored Charge Capacity (μF)
8RPS24030	30 000
8RPS24050	50 000
8RPS24100	100 000
8RPM24200	100 000
8WPS24200	100 000
8WPS24400	100 000

24 Vdc Battery Control Module

Outputs States (U = 24 Vdc: I > 5 mA, U = 230 Vac: I < 500 mA)

	No power from the power supply		Power from the power supply
	Alarm or device not supplied		No alarm
	No power from the battery pack		Power from the battery pack







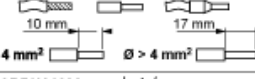

Inputs States (Dry Contact)

	Operational battery		Battery inhibited
---	---------------------	--	-------------------







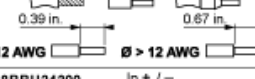

Wiring Requirements

Cable Types and Wire Sizes

IEC / EN

		ABL 8RPS24030 8RPS24050 8RPS24100	ABL 8RPM24200 8WPS24200 8WPS24400
	$\varnothing \leq 4 \text{ mm}^2$		
	$\varnothing > 4 \text{ mm}^2$		
ABL 8BBU24200	In + / -	1... 4 mm ²	4... 10 mm ²
	 + / -	6 mm ²	-
	Out + / -	6 mm ²	-
ABL 8BBU24400	In + / -	1... 4 mm ²	4... 10 mm ²
	 + / -	10 mm ²	-
	Out + / -	10 mm ²	-
	 +	10 mm ²	-
		-	-
	OFF / PSU / Alarm / 	0, 14... 1 mm ²	-

UL

		ABL 8RPS24030 8RPS24050 8RPS24100	ABL 8RPM24200 8WPS24200 8WPS24400
	$\varnothing \leq 12 \text{ AWG}$		
	$\varnothing > 12 \text{ AWG}$		
ABL 8BBU24200	In + / -	16... 12 AWG	12... 6 AWG
	 + / -	10 AWG	-
	Out + / -	10 AWG	-
ABL 8BBU24400	In + / -	16... 12 AWG	12... 6 AWG
	 + / -	6 AWG	-
	Out + / -	6 AWG	-
	 +	6 AWG	-
		-	-
	OFF / PSU / Alarm / 	26... 16 AWG	-

Recommended replacement(s)