

PRODUCT NUMBER
SEE PART NO. TABLE

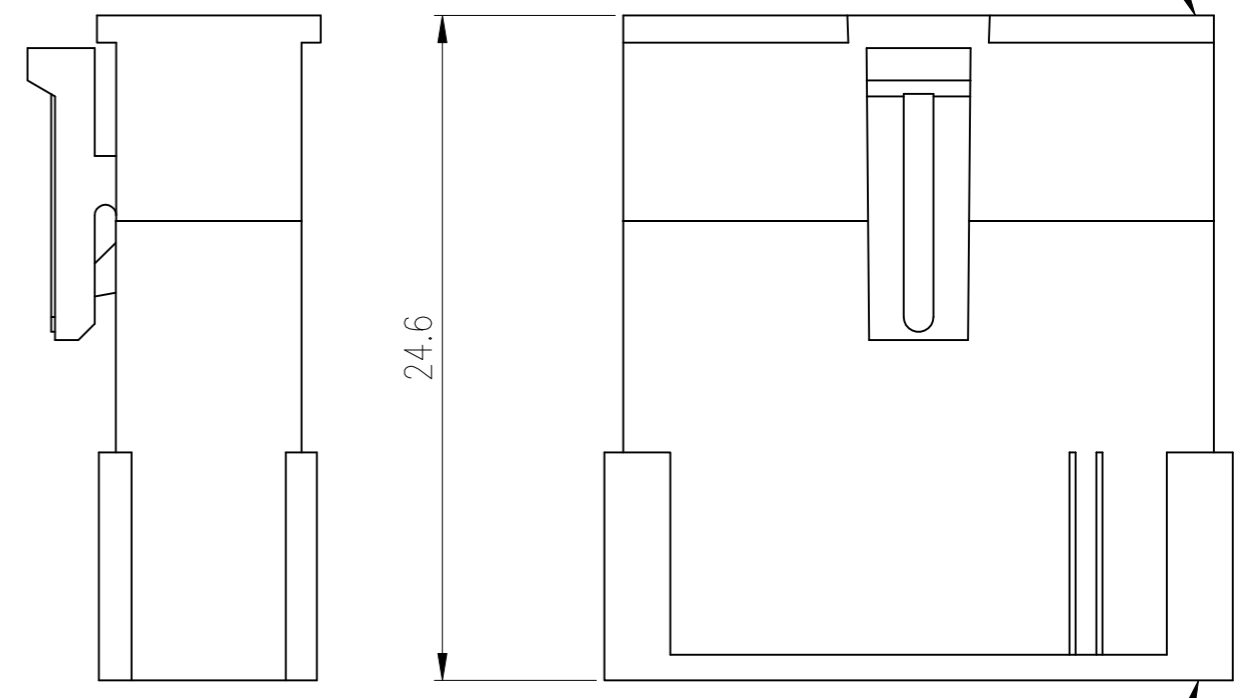
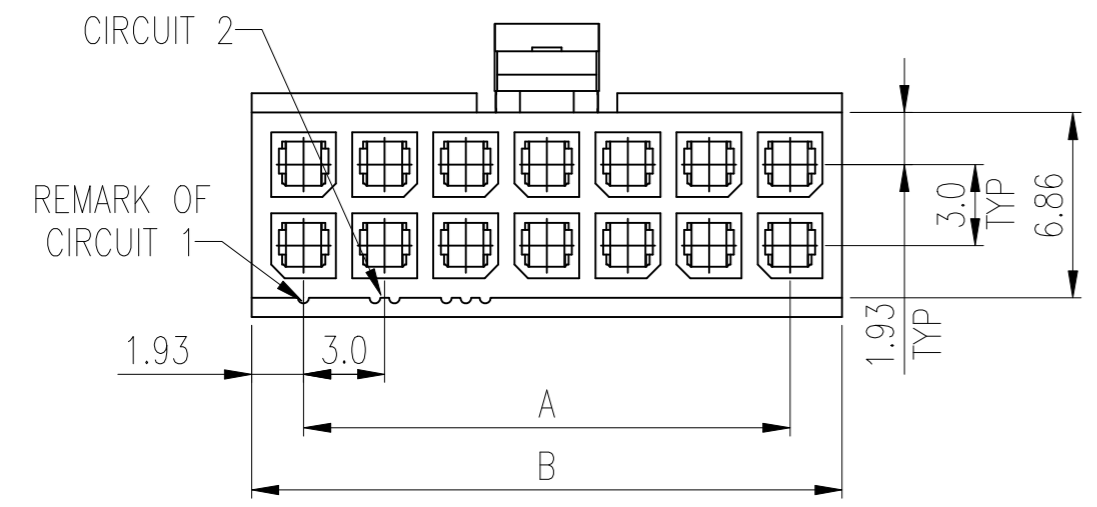
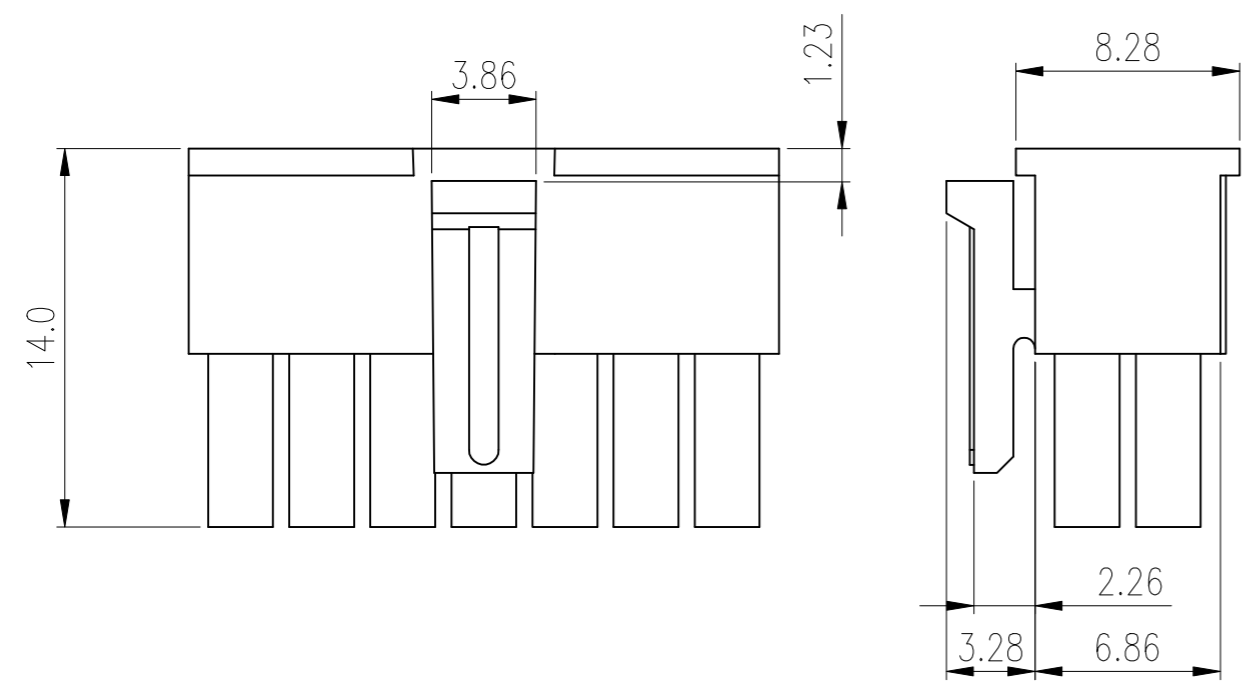
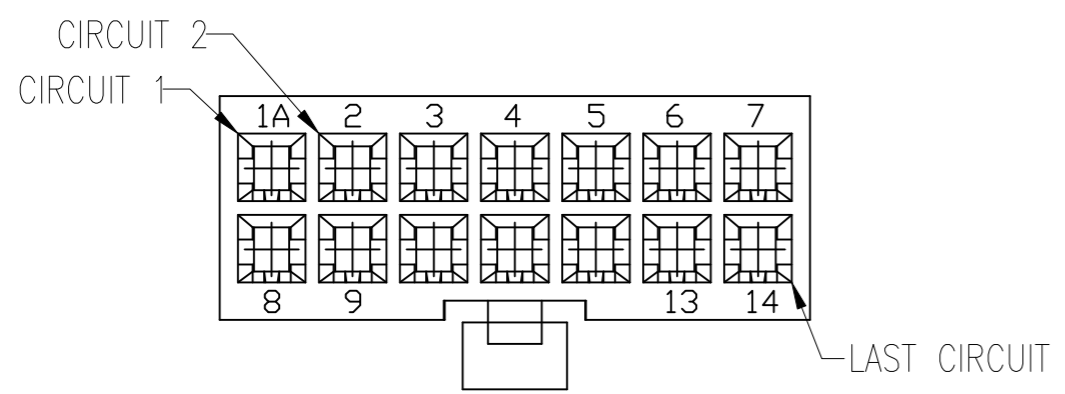

NOTE:
 1. MATERIAL:
 HOUSING: NYLON 66, HALOGEN FREE
 UL94V-0, COLOR: OPTION
 2. REFER GS-20-0399 APPLICATION SPECIFICATION FOR MATING CONNECTOR.
 3. PRODUCT SPECIFICATION: GS-12-1177.
 4. PACKAGE SPECIFICATION: GS-14-2359 (BULK PACKED)
 5. APPLICATION SPECIFICATION: GS-20-0399.
 6. LEAD FREE PRODUCTS MEET EUROPEAN UNION DIRECTIVES AND OTHER COUNTRY REGULATIONS AS DESCRIBED IN GS-47-0004
 7. PART NUMBER SCHEME:
 10127716- XX X LF
 POS. CODE: | | LEAD FREE
 02: 2 POS. | | MATERIAL
 04: 4 POS. | | BLANK: NON GLOW WIRE
 24: 24 POS. | | COMPATIBLE, BLACK.
 | | G: GLOW WIRE COMPATIBLE, BLACK.
 | | 1: NON GLOW WIRE COMPATIBLE, NATURAL
 | | 2: GLOW WIRE COMPATIBLE, NATURAL

DIMENSIONAL & PART NO. TABLE:

PART NO.	POS	A	B
10127716-02XLF	2	3.85	
10127716-04XLF	4	3.0	6.85
10127716-06XLF	6	6.0	9.85
10127716-08XLF	8	9.0	12.85
10127716-10XLF	10	12.0	15.85
10127716-12XLF	12	15.0	18.85
10127716-14XLF	14	18.0	21.85
10127716-16XLF	16	21.0	24.85
10127716-18XLF	18	24.0	27.85
10127716-20XLF	20	27.0	30.85
10127716-22XLF	22	30.0	33.85
10127716-24XLF	24	33.0	36.85

mat'l. code		surface		tolerance		projection		product family	
		ISO 1302		ISO 406 ISO 1101		mm		MINITEK PWR3.0	
ltr		ecn no		dr		date		title	
A		--		Tai		2013-10-21		MINITEK PWR3.0 WIRE CONNECTOR, RECEPTACLE HSG, DUAL ROW	
B		ELX-T-21897		Tai		2015-08-24		dwg no	
C		ELX-2-26735		MZ		2017-04-20		sheet 1 of 2	
D		ELX-N-28649		TONY		2017-11-30		size	
E		ELX-I-43460		ASLAM		2022-01-17		A3	
								10127716	
								Product Customer Drawing	
sheet index		revision sheet		E E					
				1 2					

Amphenol FCI

© 2016 AFCI

© 2016 AFci
 Amphenol FCI

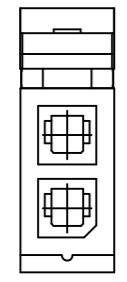

2 POS

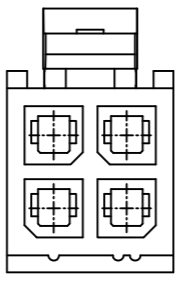

4 POS

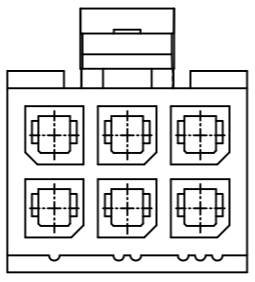

6 POS

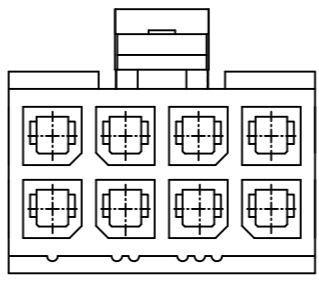

8 POS

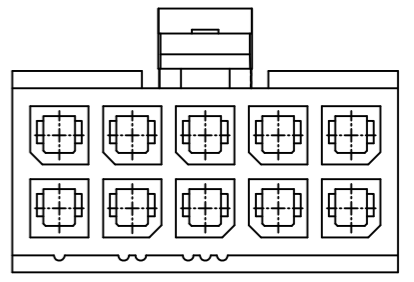

10 POS

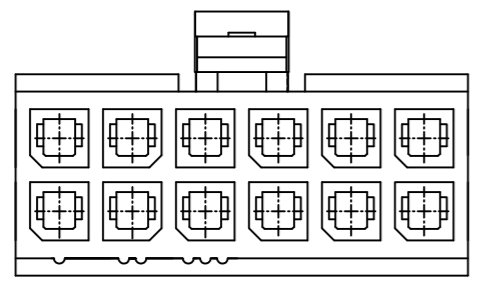

12 POS

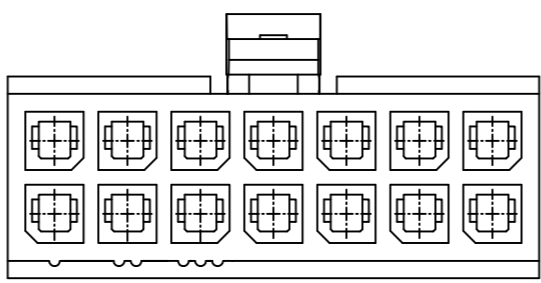

14 POS

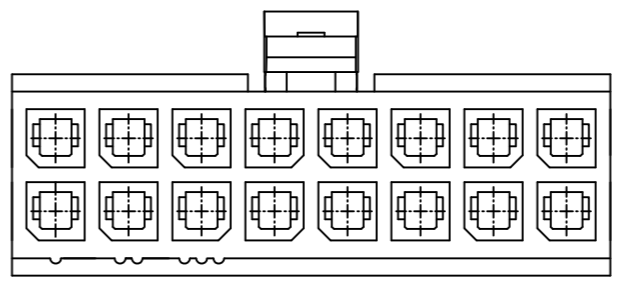

16 POS

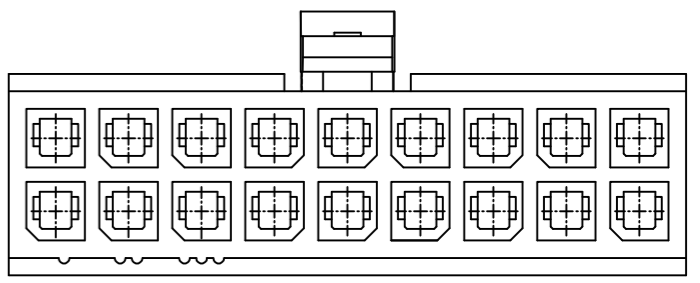

18 POS

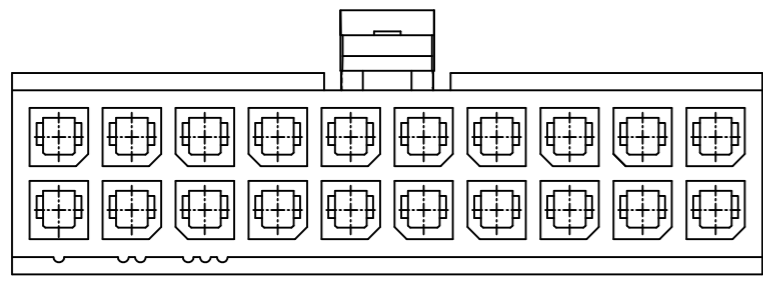

20 POS

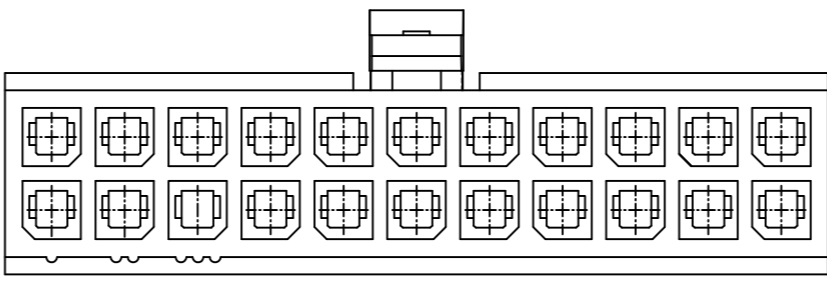

22 POS

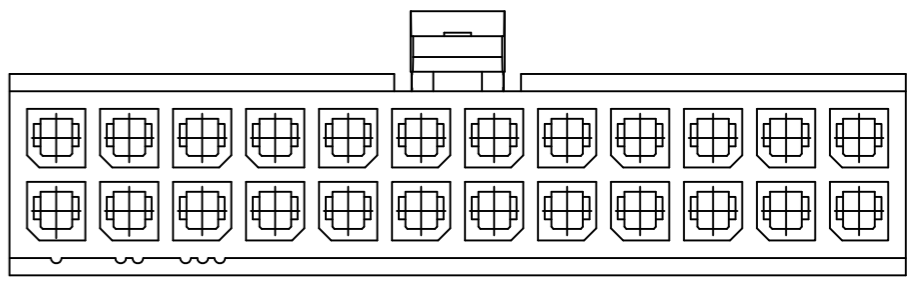

24 POS

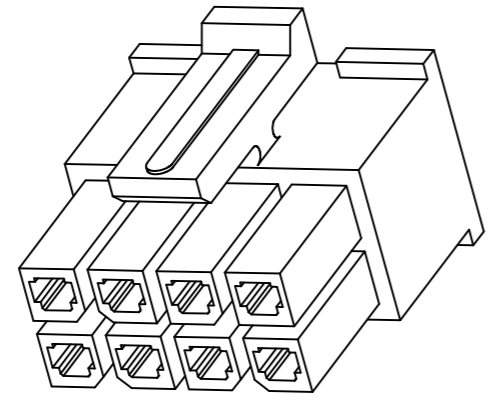

mat'l. code		surface		tolerance		projection		product family			
		ISO 1302		ISO 406 ISO 1101		mm		MINITEK PWR3.0			
ltr		ecn no		dr		date		title			
								MINITEK PWR3.0 WIRE CONNECTOR, RECEPTACLE HSG, DUAL ROW			
				angles		linear		scale		N.T.S	
				0°±3'						dwg no	
				dr		KENNY TAI		2013-10-21		sheet 2 of 2	
				enfr		AKHIL RAJAN		2022-01-17		size	
				chr		MITHUN PAUL		2022-01-17		A3	
				appd		SPK		2022-01-17		type	
										Product Customer Drawing	
sheet index		revision sheet		E 1		E 2					