

Product datasheet

Specifications



variable speed drive ATV71 - 5.5kW-7.5HP - 480V - EMC filter- graphic terminal

ATV71HU55N4

! Discontinued on: 01 June 2021

! To be end-of-service on: 01 January 2026

! Discontinued

Main

Range of product	Altivar 71
Product or component type	Variable speed drive
Product specific application	Complex, high-power machines
Component name	ATV71
Motor power kW	5.5 kW, 3 phases at 380...480 V
Motor power hp	7.5 hp, 3 phases at 380...480 V
Maximum motor cable length	50 m shielded cable 100 m unshielded cable
Power supply voltage	380...480 V - 15...10 %
Network number of phases	3 phases
Line current	17 A for 480 V 3 phases 5.5 kW / 7.5 hp 20.3 A for 380 V 3 phases 5.5 kW / 7.5 hp
EMC filter	Integrated
Assembly style	With heat sink
Apparent power	13.4 kVA at 380 V 3 phases 5.5 kW / 7.5 hp
Prospective line I _{sc}	22 kA for 3 phases
Nominal output current	11 A at 4 kHz 460 V 3 phases 5.5 kW / 7.5 hp 14.3 A at 4 kHz 380 V 3 phases 5.5 kW / 7.5 hp
Maximum transient current	21.5 A for 60 s 3 phases 5.5 kW / 7.5 hp 23.6 A for 2 s 3 phases 5.5 kW / 7.5 hp
Output frequency	0.1...599 Hz
Nominal switching frequency	4 kHz
Switching frequency	1...16 kHz adjustable 4...16 kHz with derating factor
Asynchronous motor control profile	Sensorless flux vector control (SFVC) (voltage or current vector) Voltage/frequency ratio (2 or 5 points) ENA (Energy adaptation) system for unbalanced loads Flux vector control (FVC) with sensor (current vector)
Type of polarization	No impedance for Modbus

Complementary

Product destination	Synchronous motors Asynchronous motors
---------------------	---

Power supply voltage limits	323...528 V
Power supply frequency	50...60 Hz - 5...5 %
Power supply frequency limits	47.5...63 Hz
Speed range	1...100 for asynchronous motor in open-loop mode, without speed feedback 1...1000 for asynchronous motor in closed-loop mode with encoder feedback 1...50 for synchronous motor in open-loop mode, without speed feedback
Speed accuracy	+/- 0.01 % of nominal speed in closed-loop mode with encoder feedback 0.2 Tn to Tn +/- 10 % of nominal slip without speed feedback 0.2 Tn to Tn
Torque accuracy	+/- 15 % in open-loop mode, without speed feedback +/- 5 % in closed-loop mode with encoder feedback
Transient overtorque	170 % of nominal motor torque +/- 10 % for 60 s every 10 minutes 220 % of nominal motor torque +/- 10 % for 2 s
Braking torque	<= 150 % with braking or hoist resistor 30 % without braking resistor
Synchronous motor control profile	Vector control without speed feedback
Regulation loop	Adjustable PI regulator
Motor slip compensation	Adjustable Suppressable Not available in voltage/frequency ratio (2 or 5 points) Automatic whatever the load
Diagnostic	1 LED (red) for drive voltage
Output voltage	<= power supply voltage
Insulation	Electrical between power and control
Type of cable for mounting in an enclosure	With a NEMA Type1 kit: 3 wire(s)UL 508 cable at 40 °C, copper 75 °C / PVC With an IP21 or an IP31 kit: 3 wire(s)IEC cable at 40 °C, copper 70 °C / PVC Without mounting kit: 1 wire(s)IEC cable at 45 °C, copper 70 °C / PVC Without mounting kit: 1 wire(s)IEC cable at 45 °C, copper 90 °C / XLPE/EPR
Electrical connection	Terminal, clamping capacity: 2.5 mm ² , AWG 14 (AI1-/AI1+, AI2, AO1, R1A, R1B, R1C, R2A, R2B, LI1...LI6, PWR) Terminal, clamping capacity: 6 mm ² , AWG 8 (L1/R, L2/S, L3/T, U/T1, V/T2, W/T3, PC/-, PO, PA/+, PA, PB)
Tightening torque	0.6 N.m (AI1-/AI1+, AI2, AO1, R1A, R1B, R1C, R2A, R2B, LI1...LI6, PWR) 3 N.m, 26.5 lb.in (L1/R, L2/S, L3/T, U/T1, V/T2, W/T3, PC/-, PO, PA/+, PA, PB)
Supply	Internal supply for reference potentiometer (1 to 10 kOhm): 10.5 V DC +/- 5 %, <10 mA, protection type: overload and short-circuit protection Internal supply: 24 V DC (21...27 V), <200 mA, protection type: overload and short-circuit protection
Analogue input number	2
Analogue input type	AI1-/AI1+ bipolar differential voltage: +/- 10 V DC 24 V max, resolution 11 bits + sign AI2 software-configurable current: 0...20 mA, impedance: 242 Ohm, resolution 11 bits AI2 software-configurable voltage: 0...10 V DC 24 V max, impedance: 30000 Ohm, resolution 11 bits
Input sampling time	2 ms +/- 0.5 ms (AI1-/AI1+) - analog input(s) 2 ms +/- 0.5 ms (AI2) - analog input(s) 2 ms +/- 0.5 ms (LI1...LI5) - discrete input(s) 2 ms +/- 0.5 ms (LI6)if configured as logic input - discrete input(s)
Response time	<= 100 ms in STO (Safe Torque Off) AO1 2 ms, tolerance +/- 0.5 ms for analog output(s) R1A, R1B, R1C 7 ms, tolerance +/- 0.5 ms for discrete output(s) R2A, R2B 7 ms, tolerance +/- 0.5 ms for discrete output(s)
Absolute accuracy precision	+/- 0.6 % (AI1-/AI1+) for a temperature variation 60 °C +/- 0.6 % (AI2) for a temperature variation 60 °C +/- 1 % (AO1) for a temperature variation 60 °C
Linearity error	+/- 0.15 % of maximum value (AI1-/AI1+, AI2) +/- 0.2 % (AO1)
Analogue output number	1
Analogue output type	AO1 software-configurable logic output 10 V 20 mA AO1 software-configurable current 0...20 mA, impedance: 500 Ohm, resolution 10 bits AO1 software-configurable voltage 0...10 V DC, impedance: 470 Ohm, resolution 10 bits
Discrete output number	2
Discrete output type	Configurable relay logic: (R1A, R1B, R1C) NO/NC - 100000 cycles Configurable relay logic: (R2A, R2B) NO - 100000 cycles

Minimum switching current	3 mA at 24 V DC for configurable relay logic
Maximum switching current	R1, R2: 2 A at 250 V AC inductive load, cos phi = 0.4 R1, R2: 2 A at 30 V DC inductive load, cos phi = 0.4 R1, R2: 5 A at 250 V AC resistive load, cos phi = 1 R1, R2: 5 A at 30 V DC resistive load, cos phi = 1
Discrete input number	7
Discrete input type	LI1...LI5: programmable 24 V DC with level 1 PLC, impedance: 3500 Ohm LI6: switch-configurable 24 V DC with level 1 PLC, impedance: 3500 Ohm LI6: switch-configurable PTC probe 0...6, impedance: 1500 Ohm PWR: safety input 24 V DC, impedance: 1500 Ohm conforming to ISO 13849-1 level d
Discrete input logic	Negative logic (sink) (LI1...LI5), > 16 V (state 0), < 10 V (state 1) Positive logic (source) (LI1...LI5), < 5 V (state 0), > 11 V (state 1) Negative logic (sink) (LI6)if configured as logic input, > 16 V (state 0), < 10 V (state 1) Positive logic (source) (LI6)if configured as logic input, < 5 V (state 0), > 11 V (state 1)
Acceleration and deceleration ramps	Linear adjustable separately from 0.01 to 9000 s Automatic adaptation of ramp if braking capacity exceeded, by using resistor S, U or customized
Braking to standstill	By DC injection
Protection type	Against exceeding limit speed: drive Against input phase loss: drive Break on the control circuit: drive Input phase breaks: drive Line supply overvoltage: drive Line supply undervoltage: drive Overcurrent between output phases and earth: drive Overheating protection: drive Overvoltages on the DC bus: drive Short-circuit between motor phases: drive Thermal protection: drive Motor phase break: motor Power removal: motor Thermal protection: motor
Insulation resistance	> 1 mOhm 500 V DC for 1 minute to earth
Frequency resolution	Analog input: 0.024/50 Hz Display unit: 0.1 Hz
Communication port protocol	CANopen Modbus
Connector type	1 RJ45 (on front face) for Modbus 1 RJ45 (on terminal) for Modbus Male SUB-D 9 on RJ45 for CANopen
Physical interface	2-wire RS 485 for Modbus
Transmission frame	RTU for Modbus
Transmission rate	4800 bps, 9600 bps, 19200 bps, 38.4 Kbps for Modbus on terminal 9600 bps, 19200 bps for Modbus on front face 20 kbps, 50 kbps, 125 kbps, 250 kbps, 500 kbps, 1 Mbps for CANopen
Data format	8 bits, 1 stop, even parity for Modbus on front face 8 bits, odd even or no configurable parity for Modbus on terminal
Number of addresses	1...127 for CANopen 1...247 for Modbus
Method of access	Slave CANopen
Marking	CE
Operating position	Vertical +/- 10 degree
Height	295 mm
Depth	187 mm
Width	175 mm
Net weight	5.5 kg
Functionality	Full
Specific application	Other applications
Option card	Communication card for CC-Link Controller inside programmable card Communication card for DeviceNet Communication card for EtherNet/IP Communication card for Fipio

I/O extension card
 Communication card for Interbus-S
 Interface card for encoder
 Communication card for Modbus Plus
 Communication card for Modbus TCP
 Communication card for Modbus/Uni-Telway
 Overhead crane card
 Communication card for Profibus DP
 Communication card for Profibus DP V1

Environment

Noise level	55.6 dB conforming to 86/188/EEC
Dielectric strength	3535 V DC between earth and power terminals 5092 V DC between control and power terminals
Electromagnetic compatibility	1.2/50 µs - 8/20 µs surge immunity test level 3 conforming to IEC 61000-4-5 Conducted radio-frequency immunity test level 3 conforming to IEC 61000-4-6 Electrical fast transient/burst immunity test level 4 conforming to IEC 61000-4-4 Electrostatic discharge immunity test level 3 conforming to IEC 61000-4-2 Radiated radio-frequency electromagnetic field immunity test level 3 conforming to IEC 61000-4-3 Voltage dips and interruptions immunity test conforming to IEC 61000-4-11
Standards	IEC 60721-3-3 class 3C1 EN/IEC 61800-5-1 UL Type 1 EN 61800-3 environments 2 category C3 IEC 60721-3-3 class 3S2 EN/IEC 61800-3 EN 61800-3 environments 1 category C3 EN 55011 class A group 2
Product certifications	GOST CSA NOM 117 UL C-Tick
Pollution degree	2 conforming to EN/IEC 61800-5-1
IP degree of protection	IP20
Vibration resistance	1 gn (f= 13...200 Hz) conforming to EN/IEC 60068-2-6 1.5 mm peak to peak (f= 3...13 Hz) conforming to EN/IEC 60068-2-6
Shock resistance	15 gn for 11 ms conforming to EN/IEC 60068-2-27
Relative humidity	5...95 % without condensation conforming to IEC 60068-2-3 5...95 % without dripping water conforming to IEC 60068-2-3
Ambient air temperature for operation	-10...50 °C (without derating)
Ambient air temperature for storage	-25...70 °C
Operating altitude	<= 1000 m without derating 1000...3000 m with current derating 1 % per 100 m

Offer Sustainability

Sustainable offer status	Green Premium product
EU RoHS Directive	Pro-active compliance (Product out of EU RoHS legal scope) EU RoHS Declaration
Mercury free	Yes
China RoHS Regulation	China RoHS declaration
RoHS exemption information	Yes
Environmental Disclosure	Product Environmental Profile
Circularity Profile	End of Life Information
WEEE	The product must be disposed on European Union markets following specific waste collection and never end up in rubbish bins

Contractual warranty

Warranty	18 months
-----------------	-----------

UL Type 1/IP 20 Drives

Dimensions without Option Card

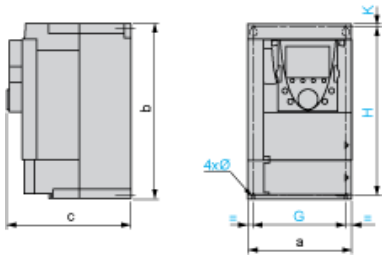

Dimensions in mm

a	b	c	G	H	K	Ø
175	295	187	158	283	6	5

Dimensions in in.

a	b	c	G	H	K	Ø
6.89	11.61	7.36	6.22	11.14	0.23	0.19

Dimensions with 1 Option Card (1)

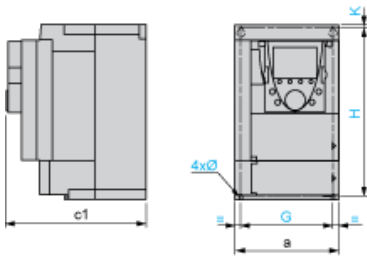

Dimensions in mm

a	c1	G	H	K	Ø
175	210	158	283	6	5

Dimensions in in.

a	c1	G	H	K	Ø
6.89	8.26	6.22	11.14	0.23	0.19

(1) Option cards: I/O extension cards, communication cards or "Controller Inside" programmable card.

Dimensions with 2 Option Cards (1)

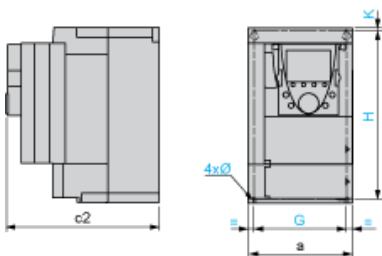

Dimensions in mm

a	c2	G	H	K	Ø
175	233	158	283	6	5

Dimensions in in.

a	c2	G	H	K	Ø
6.89	9.17	6.22	11.14	0.23	0.19

(1) Option cards: I/O extension cards, communication cards or "Controller Inside" programmable card.

Mounting Recommendations

Depending on the conditions in which the drive is to be used, its installation will require certain precautions and the use of appropriate accessories.

Install the unit vertically:

- Avoid placing it close to heating elements
- Leave sufficient free space to ensure that the air required for cooling purposes can circulate from the bottom to the top of the unit.

Clearance

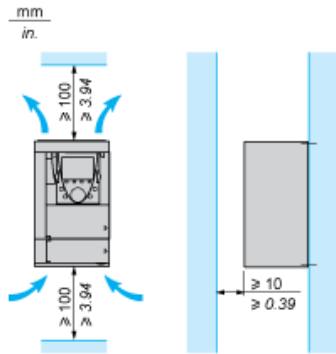

Mounting Types

Type A Mounting

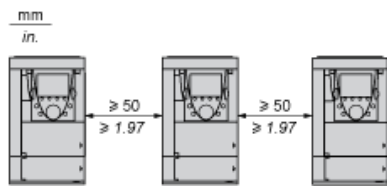

Type B Mounting

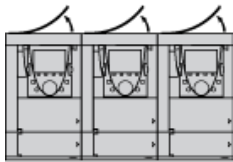

Type C Mounting

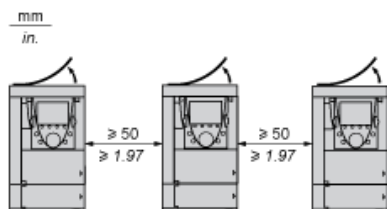

By removing the protective blanking cover from the top of the drive, the degree of protection for the drive becomes IP 20.

The protective blanking cover may vary according to the drive model (refer to the user guide).

The protective blanking cover must be removed from ATV 71P••N4Z drives when they are mounted in a dust and damp proof enclosure.

Specific Recommendations for Mounting the Drive in an Enclosure

Ventilation

To ensure proper air circulation in the drive:

- Fit ventilation grilles.
- Ensure that there is sufficient ventilation. If there is not, install a forced ventilation unit with a filter. The openings and/or fans must provide a flow rate a

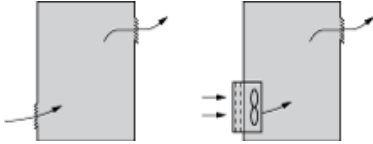

- Use special filters with IP 54 protection.
- Remove the blanking cover from the top of the drive.

Dust and Damp Proof Metal Enclosure (IP 54)

The drive must be mounted in a dust and damp proof enclosure in certain environmental conditions: dust, corrosive gases, high humidity with risk of condensation and dripping water, splashing liquid, etc.

This enables the drive to be used in an enclosure where the maximum internal temperature reaches 50°C.

Wiring Diagram Conforming to Standards EN 954-1 Category 1, IEC/EN 61508 Capacity SIL1, in Stopping Category 0 According to IEC/EN 60204-1

Three-Phase Power Supply with Upstream Breaking via Contactor

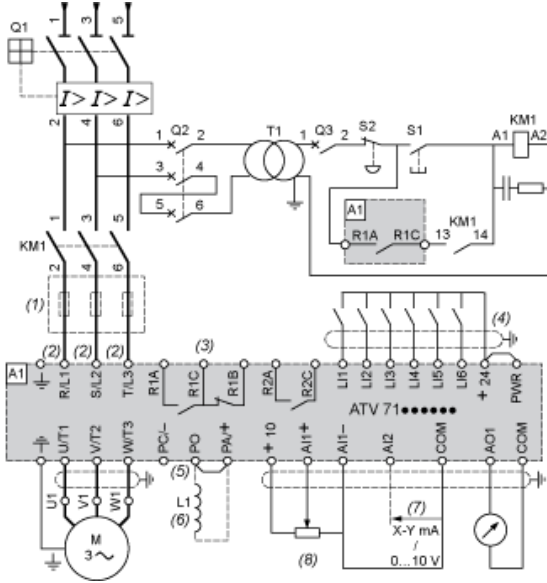

A1 ATV71 drive

KM1 Contactor

L1 DC choke

Q1 Circuit-breaker

Q2 GV2 L rated at twice the nominal primary current of T1

Q3 GB2CB05

S1, S2 XB4 B or XB5 A pushbuttons

T1 100 VA transformer 220 V secondary

(1) Line choke (three-phase); mandatory for ATV71HC11Y...HC63Y drives (except when a special transformer is used (12-pulse)).

(2) For ATV71HC40N4 drives combined with a 400 kW motor, ATV71HC50N4 and ATV71HC40Y...HC63Y, refer to the power terminal connections

(3) Fault relay contacts. Used for remote signalling of the drive status.

(4) Connection of the common for the logic inputs depends on the positioning of the SW1 switch. The above diagram shows the internal power supply

(5) There is no PO terminal on ATV71HC11Y...HC63Y drives.

(6) Optional DC choke for ATV71H...M3, ATV71HD11M3X...HD45M3X, ATV71•075N4...•D75N4 and ATV71P...N4Z drives. Connected in place of

(7) Software-configurable current (0...20 mA) or voltage (0...10 V) analog input.

(8) Reference potentiometer.

All terminals are located at the bottom of the drive. Fit interference suppressors on all inductive circuits near the drive or connected on the same circuit, such as relays, contactors, solenoid valves, fluorescent lighting, etc.

Wiring Diagram Conforming to Standards EN 954-1 Category 1, IEC/EN 61508 Capacity SIL1, in Stopping Category 0 According to IEC/EN 60204-1

Three-Phase Power Supply with Downstream Breaking via Switch Disconnecter

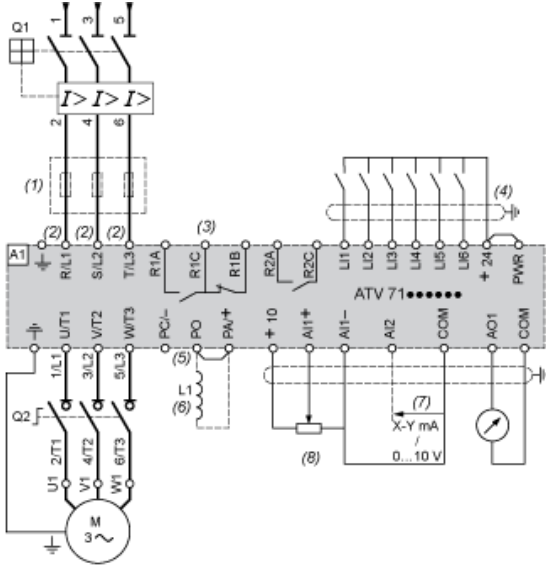

A1 ATV71 drive
L1 DC choke
Q1 Circuit-breaker
Q2 Switch disconnecter (Vario)

- (1) Line choke (three-phase), mandatory for ATV71HC11Y...HC63Y drives (except when a special transformer is used (12-pulse)).
- (2) For ATV71HC40N4 drives combined with a 400 kW motor, ATV71HC50N4 and ATV71HC40Y...HC63Y, refer to the power terminal connections
- (3) Fault relay contacts. Used for remote signalling of the drive status.
- (4) Connection of the common for the logic inputs depends on the positioning of the SW1 switch. The above diagram shows the internal power supply
- (5) There is no PO terminal on ATV71HC11Y...HC63Y drives.
- (6) Optional DC choke for ATV71H...M3, ATV71HD11M3X...HD45M3X, ATV71•075N4...•D75N4 and ATV71P...N4Z drives. Connected in place of
- (7) Software-configurable current (0...20 mA) or voltage (0...10 V) analog input.
- (8) Reference potentiometer.

All terminals are located at the bottom of the drive. Fit interference suppressors on all inductive circuits near the drive or connected on the same circuit, such as relays, contactors, solenoid valves, fluorescent lighting, etc.

Wiring Diagram Conforming to Standards EN 954-1 Category 3, IEC/EN 61508 Capacity SIL2, in Stopping Category 0 According to IEC/EN 60204-1

Three-Phase Power Supply, Low Inertia Machine, Vertical Movement

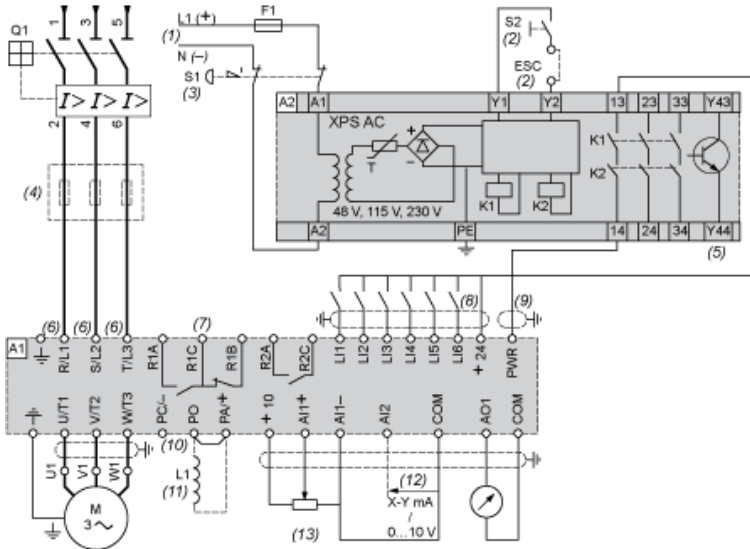

- A1 ATV71 drive
- A2 Preventa XPS AC safety module for monitoring emergency stops and switches. One safety module can manage the “Power Removal” function for up to 2 drives.
- F1 Fuse
- L1 DC choke
- Q1 Circuit-breaker
- S1 Emergency stop button with 2 contacts
- S2 XB4 B or XB5 A pushbutton
- (1) Power supply: 24 Vdc or Vac, 48 Vac, 115 Vac, 230 Vac.
- (2) S2: resets XPS AC module on power-up or after an emergency stop. ESC can be used to set external starting conditions.
- (3) Requests freewheel stopping of the movement and activates the “Power Removal” safety function.
- (4) Line choke (three-phase), mandatory for and ATV71HC11Y...HC63Y drives (except when a special transformer is used (12-pulse)).
- (5) The logic output can be used to signal that the machine is in a safe stop state.
- (6) For ATV71HC40N4 drives combined with a 400 kW motor, ATV71HC50N4 and ATV71HC40Y...HC63Y, refer to the power terminal connections in the manual.
- (7) Fault relay contacts. Used for remote signalling of the drive status.
- (8) Connection of the common for the logic inputs depends on the positioning of the SW1 switch. The above diagram shows the internal power supply connection.
- (9) Standardized coaxial cable, type RG174/U according to MIL-C17 or KX3B according to NF C 93-550, external diameter 2.54 mm /0.09 in., maximum length 100 m.
- (10) There is no PO terminal on ATV71HC11Y...HC63Y drives.
- (11) Optional DC choke for ATV71H...M3, ATV71HD11M3...HD45M3X, ATV71•075N4...•D75N4 and ATV71P...N4Z drives. Connected in place of L1.
- (12) Software-configurable current (0...20 mA) or voltage (0...10 V) analog input.
- (13) Reference potentiometer.

All terminals are located at the bottom of the drive. Fit interference suppressors on all inductive circuits near the drive or connected on the same circuit, such as relays, contactors, solenoid valves, fluorescent lighting, etc.

Wiring Diagram Conforming to Standards EN 954-1 Category 3, IEC/EN 61508 Capacity SIL2, in Stopping Category 1 According to IEC/EN 60204-1

Three-Phase Power Supply, High Inertia Machine

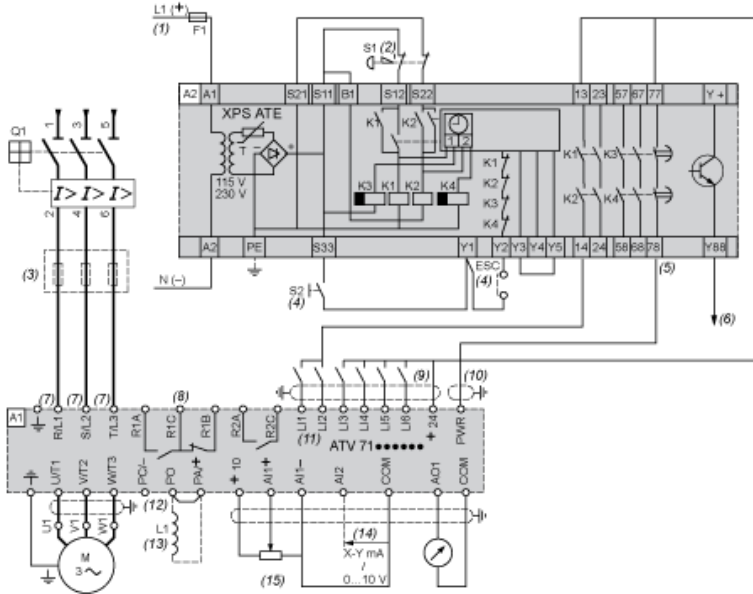

- A1** ATV71 drive
- A2 (5)** Preventa XPS ATE safety module for monitoring emergency stops and switches. One safety module can manage the "Power Removal" safety function.
- F1** Fuse
- L1** DC choke
- Q1** Circuit-breaker
- S1** Emergency stop button with 2 N/C contacts
- S2** Run button
- (1)** Power supply: 24 Vdc or Vac, 115 Vac, 230 Vac.
- (2)** Requests controlled stopping of the movement and activates the "Power Removal" safety function.
- (3)** Line choke (three-phase), mandatory for ATV71HC11Y...HC63Y drives (except when a special transformer is used (12-pulse)).
- (4)** S2: resets XPS ATE module on power-up or after an emergency stop. ESC can be used to set external starting conditions.
- (5)** For stopping times requiring more than 30 seconds in category 1, use a Preventa XPS AV safety module which can provide a maximum time delay.
- (6)** The logic output can be used to signal that the machine is in a safe state.
- (7)** For ATV71HC40N4 drives combined with a 400 kW motor, ATV71HC50N4 and ATV71HC40Y...HC63Y, refer to the power terminal connections.
- (8)** Fault relay contacts. Used for remote signalling of the drive status.
- (9)** Connection of the common for the logic inputs depends on the positioning of the SW1 switch. The above diagram shows the internal power supply.
- (10)** Standardized coaxial cable, type RG174/U according to MIL-C17 or KX3B according to NF C 93-550, external diameter 2.54 mm/0.09 in., maximum length 100 m.
- (11)** Logic inputs LI1 and LI2 must be assigned to the direction of rotation: LI1 in the forward direction and LI2 in the reverse direction.
- (12)** There is no PO terminal on ATV71HC11Y...HC63Y drives.
- (13)** Optional DC choke for ATV71H...M3, ATV71HD11M3X...HD45M3X, ATV71•075N4...•D75N4 and ATV71P...N4Z drives. Connected in place of L2.
- (14)** Software-configurable current (0...20 mA) or voltage (0...10 V) analog input.
- (15)** Reference potentiometer.

All terminals are located at the bottom of the drive. Fit interference suppressors on all inductive circuits near the drive or connected on the same circuit, such as relays, contactors, solenoid valves, fluorescent lighting, etc.

Derating Curves

The derating curves for the drive nominal current (I_n) depend on the temperature, the switching frequency and the mounting type. For intermediate temperatures (e.g. 55°C), interpolate between 2 curves.

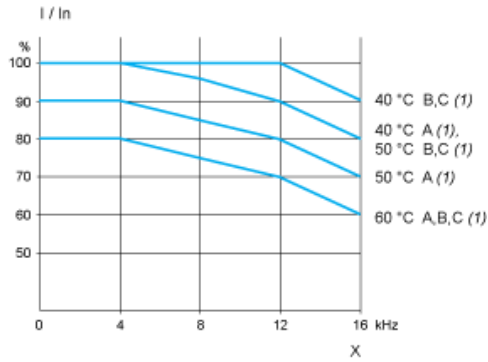

X Switching frequency
(1) Mounting type

Recommended replacement(s)

ATV71HU55N4 may be replaced by any of the following products:

1x  Variable speed drive, Altivar Process ATV900, ATV930, 7,5 kW, 400/480 V, with braking unit, IP21
ATV930U75N4

1x  Variable speed drive, Altivar Machine ATV340, 5.5 kW Heavy Duty, 400 V, 3 phases
ATV340U55N4