

**2 HOLES FLANGE JACK RECEPTACLE
WITH CYLINDRICAL CONTACT**

R125.464.001

Series : SMA

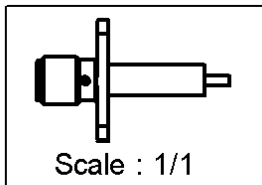
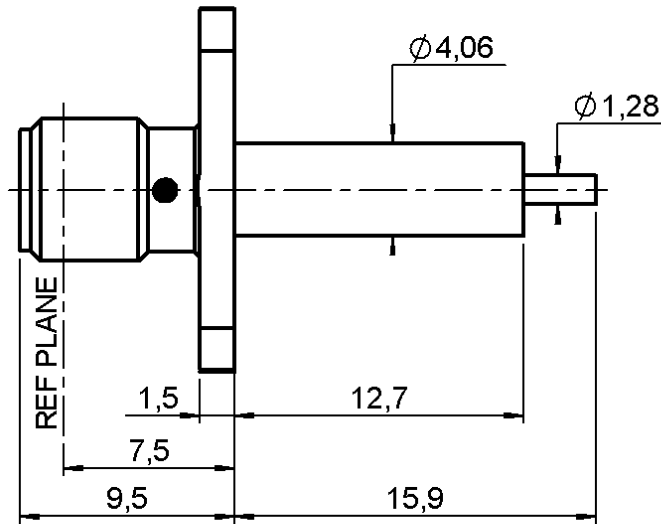
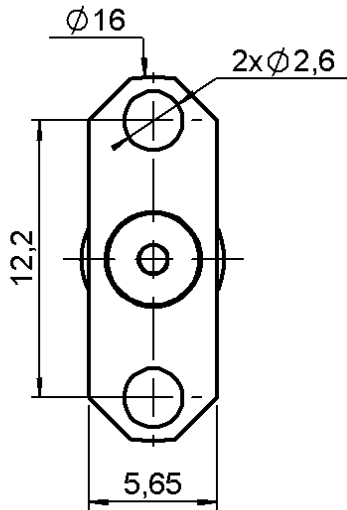

PANEL CUT OUT

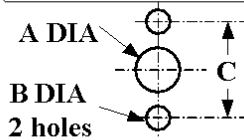

	mm	
	Maxi	mini
A	4.2	4.1
B	2.65	2.6
C	12.25	12.15

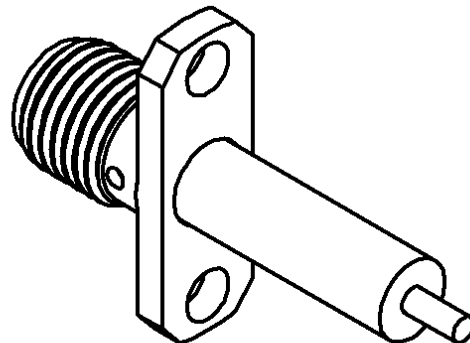

All dimensions are in mm.

COMPONENTS	MATERIALS	PLATINGS (µm)
BODY	STAINLESS STEEL	PASSIVATED .
CENTER CONTACT	BERYLLIUM COPPER	GOLD 1.3 OVER NICKEL 2
OUTER CONTACT	-	-
INSULATOR	PTFE	-
GASKET	-	-
OTHERS PARTS	-	-
-	-	-
-	-	-

Issue : 0222 C

In the effort to improve our products, we reserve the right to make changes judged to be necessary.



**2 HOLES FLANGE JACK RECEPTACLE
WITH CYLINDRICAL CONTACT**

R125.464.001

Series : SMA

PACKAGING

SPECIFICATION

Standard	Unit	Other
100	'W' option	Contact us

ELECTRICAL CHARACTERISTICS

ENVIRONMENTAL

Impedance		50 Ω
Frequency		0-18 GHz
VSWR	1.06 +	0.002 x F(GHz) Maxi
Insertion loss		0.07* √F(GHz) dB Maxi
RF leakage	- (60 - F(GHz)) dB Maxi
Voltage rating		500 Veff Maxi
Dielectric withstanding voltage		1000 Veff mini
Insulation resistance		5000 MΩ mini

Operating temperature	-65/+165 ° C
Hermetic seal	NA Atm.cm3/s
Panel leakage	NA

OTHERS CHARACTERISTICS

Assembly instruction **NA**

Others :

* Coaxial Transmission Line Only

MECHANICAL CHARACTERISTICS

Center contact retention		
Axial force – Mating end	27	N mini
Axial force – Opposite end	27	N mini
Torque	2.8	N.cm mini
Recommended torque		
Mating	NA	N.cm
Panel nut	NA	N.cm
Mating life	500	Cycles mini
Weight	2.100	g

Issue : 0222 C

In the effort to improve our products, we reserve the right to make changes judged to be necessary.

