

STRAIGHT PLUGS, CRIMP TYPE, FOR FLEXIBLE CABLES

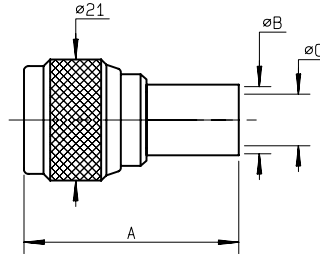

cable	part number	dimensions			captured center contact	mounting
		A	B	C		
6 / 75 / S	R162 084 000	33.9	6.6	4	YES	M33
10 / 75 / S	R162 075 000	37.25	11.05	7.46	YES	M33
11 / 75 / D	R162 088 000	37.25	11.4	7.46	YES	M33

STRAIGHT PLUGS, CLAMP TYPE, FOR FLEXIBLE CABLES

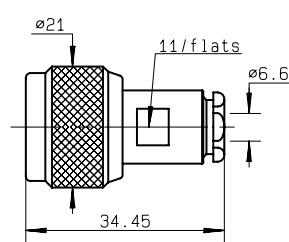

Fig. 1

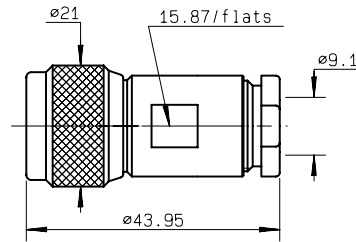

Fig. 2

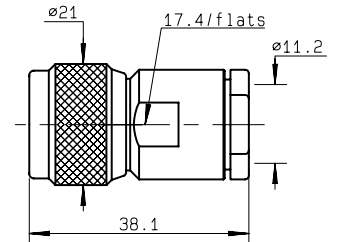
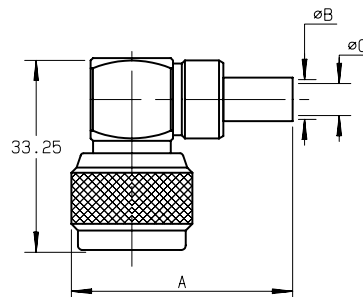

Fig. 3

cable	part number	fig.	captured center contact	mounting
6 / 75 + 93	R162 012 000	1	NO	M02
8 / 75 / D	R162 013 000	2	NO	M16
10 + 11 / 75	R162 017 000	3	NO	M04

RIGHT ANGLE PLUGS, CRIMP TYPE, FOR FLEXIBLE CABLES



cable	part number	dimensions			captured center contact	mounting
		A	B	C		
6 / 75 / S	R162 184 000	38.25	6.6	4	YES	M33
10 / 75 / S	R162 185 000	42.25	11.05	7.46	YES	M33
11 / 75 / D	R162 187 000	42.25	11.4	7.46	YES	M33

Note : standard packaging = 50 pieces. For unit packaging, add "W" after the P/N.

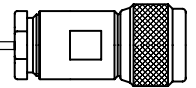

RIGHT ANGLE PLUGS, CLAMP TYPE, FOR FLEXIBLE CABLES

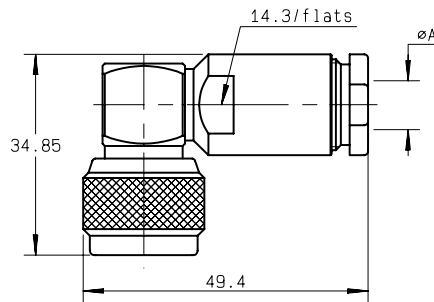

cable	part number	dimensions A	captured center contact	mounting
6 / 75 + 93	R162 162 000	6.5	YES	M16
10 + 11 / 75	R162 168 000	11.2	YES	M16

STRAIGHT JACKS, CRIMP TYPE, FOR FLEXIBLE CABLES

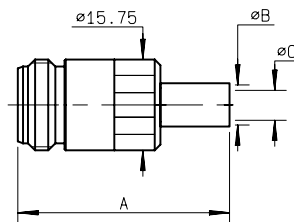

cable	part number	dimensions			captured center contact	mounting
		A	B	C		
6 / 75 / S	R162 239 000	36.6	6.6	4	YES	M33
10 / 75 / S	R162 241 000	40.6	11.05	7.46	YES	M33
11 / 75 / D	R162 243 000	40.6	11.4	7.46	YES	M33

STRAIGHT JACKS, CLAMP TYPE, FOR FLEXIBLE CABLES

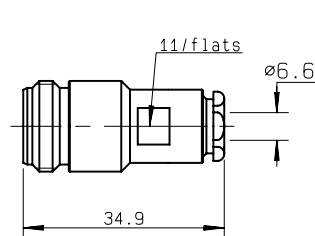

Fig. 1

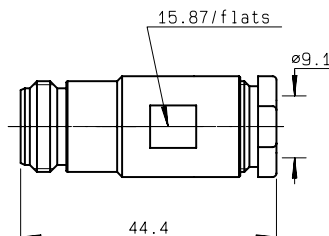

Fig. 2

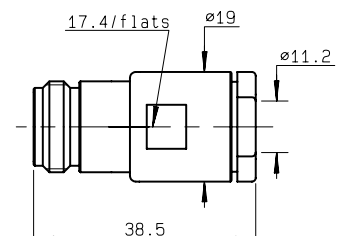

Fig. 3

cable	part number	fig.	captured center contact	mounting
6 / 75 + 93 / S	R162 212 000	1	NO	M02
8 / 75 / D	R162 213 000	2	NO	M16
10 + 11 / 75	R162 217 000	3	NO	M04

Note : standard packaging = 50 pieces. For unit packaging, add "W" after the P/N.