

# MKKDSN 1,5/ 6 - PCB terminal block



1726134

<https://www.phoenixcontact.com/in/products/1726134>

Please be informed that the data shown in this PDF document is generated from our Online Catalog. Please find the complete data in the user documentation. Our General Terms of Use for Downloads are valid.

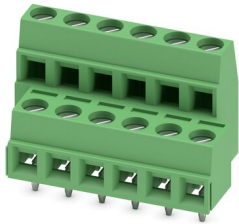

PCB terminal block, nominal current: 13.5 A, rated voltage (III/2): 400 V, nominal cross section: 1.5 mm<sup>2</sup>, number of potentials: 12, number of rows: 2, number of positions per row: 6, product range: MKKDSN 1,5, pitch: 5 mm, connection method: Screw connection with tension sleeve, screw head form: L Slotted, mounting: Wave soldering, conductor/PCB connection direction: 0 °, color: green, Pin layout: Linear pinning, Solder pin [P]: 3.5 mm, number of solder pins per potential: 1, type of packaging: packed in cardboard. The article can be aligned to create different nos. of positions!

## Your advantages

- Well-known connection principle allows worldwide use
- Low temperature rise, thanks to maximum contact force
- Allows connection of two conductors
- Extremely small design for the respective conductor cross section
- Conductor connection on several levels enables higher contact density
- The latching on the side enables various numbers of positions to be combined

## Commercial Data

Item number	1726134
Packing unit	50 pc
Minimum order quantity	50 pc
Sales Key	AAL
Product Key	AALFJK
Catalog Page	Page 93 (C-1-2013)
GTIN	4017918025403
Weight per Piece (including packing)	13.87 g
Weight per Piece (excluding packing)	13.78 g
Customs tariff number	85369010
Country of origin	CN

# MKKDSN 1,5/ 6 - PCB terminal block



1726134

<https://www.phoenixcontact.com/in/products/1726134>

## Technical Data

### Product properties

Type	PC terminal block can be aligned
Product line	COMBICON Terminals S
Product type	Printed circuit board terminal
Product family	MKKDSN 1,5
Number of positions	6
Pitch	5 mm
Number of connections	12
Number of rows	2
Number of potentials	12
Pin layout	Linear pinning
Solder pins per potential	1

### Electrical properties

Nominal current $I_N$	13.5 A
Nominal voltage $U_N$	400 V
Degree of pollution	3
Rated voltage (III/3)	250 V
Rated surge voltage (III/3)	4 kV
Rated voltage (III/2)	400 V
Rated surge voltage (III/2)	4 kV
Rated voltage (II/2)	630 V
Rated surge voltage (II/2)	4 kV

### Connection data

#### Connection technology

Type	PC terminal block can be aligned
Nominal cross section	1.5 mm <sup>2</sup>

#### Conductor connection

Connection method	Screw connection with tension sleeve
Conductor cross section rigid	0.14 mm <sup>2</sup> ... 1.5 mm <sup>2</sup>
Conductor cross section flexible	0.14 mm <sup>2</sup> ... 1.5 mm <sup>2</sup>
Conductor cross section AWG	26 ... 16
Conductor cross section flexible, with ferrule without plastic sleeve	0.25 mm <sup>2</sup> ... 1 mm <sup>2</sup>
Conductor cross section, flexible, with ferrule, with plastic sleeve	0.25 mm <sup>2</sup> ... 1.5 mm <sup>2</sup>
2 conductors with same cross section, solid	0.14 mm <sup>2</sup> ... 0.75 mm <sup>2</sup>
2 conductors with same cross section, flexible	0.14 mm <sup>2</sup> ... 0.75 mm <sup>2</sup>
2 conductors with same cross section, flexible, with ferrule without plastic sleeve	0.25 mm <sup>2</sup> ... 0.5 mm <sup>2</sup>

# MKKDSN 1,5/ 6 - PCB terminal block



1726134

<https://www.phoenixcontact.com/in/products/1726134>

2 conductors with the same cross section, flexible, with TWIN ferrule with plastic sleeve	0.5 mm <sup>2</sup> ... 1 mm <sup>2</sup> (1st level: 0.5 mm <sup>2</sup> ... 1 mm <sup>2</sup> / 2nd level: 0.5 mm <sup>2</sup> )
Stripping length	6 mm
Tightening torque	0.5 Nm ... 0.6 Nm

## Mounting

Mounting type	Wave soldering
Pin layout	Linear pinning
Drive form screw head	Slotted (L)
Drive form screw head	Slotted (L)

## Material specifications

### Material data - contact

Note	WEEE/RoHS-compliant, free of whiskers according to IEC 60068-2-82/JEDEC JESD 201
Contact material	Cu alloy
Surface characteristics	Tin-plated
Metal surface terminal point (top layer)	Tin (5 - 7 µm Sn)
Metal surface terminal point (middle layer)	Nickel (2 - 3 µm Ni)
Metal surface soldering area (top layer)	Tin (5 - 7 µm Sn)
Metal surface soldering area (middle layer)	Nickel (2 - 3 µm Ni)

### Material data - housing

Color (Housing)	green (6021)
Insulating material	PA
Insulating material group	I
CTI according to IEC 60112	600
Flammability rating according to UL 94	V0
Glow wire flammability index GWFI according to EN 60695-2-12	850
Glow wire ignition temperature GWIT according to EN 60695-2-13	775
Temperature for the ball pressure test according to EN 60695-10-2	125 °C

### Material data – actuating element

Color ( )	( )
-----------	-----

## Dimensions

Dimensional drawing	
Pitch	5 mm
Width [w]	32.5 mm

# MKKDSN 1,5/ 6 - PCB terminal block



1726134

<https://www.phoenixcontact.com/in/products/1726134>

Height [h]	22.6 mm
Length [l]	18.3 mm
Installed height	19.1 mm
Solder pin length [P]	3.5 mm

## PCB design

Pin spacing	10 mm
-------------	-------

## Mechanical tests

### Test for conductor damage and slackening

Specification	IEC 60999-1:1999-11
Result	Test passed

### Pull-out test

Specification	IEC 60999-1:1999-11
Conductor cross section/conductor type/tractive force setpoint/actual value	0.14 mm <sup>2</sup> / solid / > 10 N
	0.14 mm <sup>2</sup> / flexible / > 10 N
	1.5 mm <sup>2</sup> / solid / > 40 N
	1.5 mm <sup>2</sup> / flexible / > 40 N

## Electrical tests

### Temperature-rise test

Specification	IEC 60947-7-4:2019-01
Requirement temperature-rise test	The sum of ambient temperature and temperature rise of the PCB terminal block shall not exceed the upper limiting temperature.

### Short-time withstand current

Specification	IEC 60947-7-4:2019-01
---------------	-----------------------

### Insulation resistance

Specification	IEC 60512-3-1:2002-02
Insulation resistance, neighboring positions	> 5 MΩ

### Air clearances and creepage distances |

Specification	IEC 60947-1:2007-06 + A1:2010-12 + A2:2014-09
Insulating material group	I
Comparative tracking index (IEC 60112)	CTI 600
Rated insulation voltage (III/3)	250 V
Rated surge voltage (III/3)	4 kV
minimum clearance value - non-homogenous field (III/3)	3 mm
minimum creepage distance (III/3)	3.2 mm
Note on connection cross section	With connected conductor 1.5 mm <sup>2</sup> (solid).
Rated insulation voltage (III/2)	400 V
Rated surge voltage (III/2)	4 kV
minimum clearance value - non-homogenous field (III/2)	3 mm

# MKKDSN 1,5/ 6 - PCB terminal block



1726134

<https://www.phoenixcontact.com/in/products/1726134>

minimum creepage distance (III/2)	3 mm
Rated insulation voltage (II/2)	630 V
Rated surge voltage (II/2)	4 kV
minimum clearance value - non-homogenous field (II/2)	3 mm
minimum creepage distance (II/2)	3.2 mm

## Environmental and real-life conditions

### Vibration test

Specification	IEC 60068-2-6:2007-12
Frequency	10 - 150 - 10 Hz
Sweep speed	1 octave/min
Amplitude	0.35 mm (10 Hz ... 60.1 Hz)
Sweep speed	5g (60.1 Hz ... 150 Hz)
Test duration per axis	2.5 h

### Glow-wire test

Specification	IEC 60695-2-10:2013-04
Temperature	850 °C
Time of exposure	5 s

### Aging

Specification	IEC 60947-7-4:2019-01
---------------	-----------------------

### Ambient conditions

Ambient temperature (operation)	-40 °C ... 105 °C (Depending on the current carrying capacity/derating curve)
Ambient temperature (storage/transport)	-40 °C ... 70 °C
Relative humidity (storage/transport)	30 % ... 70 %
Ambient temperature (assembly)	-5 °C ... 100 °C

## Packaging specifications

Type of packaging	packed in cardboard
-------------------	---------------------

# MKKDSN 1,5/ 6 - PCB terminal block

1726134

<https://www.phoenixcontact.com/in/products/1726134>

## Drawings

Diagram

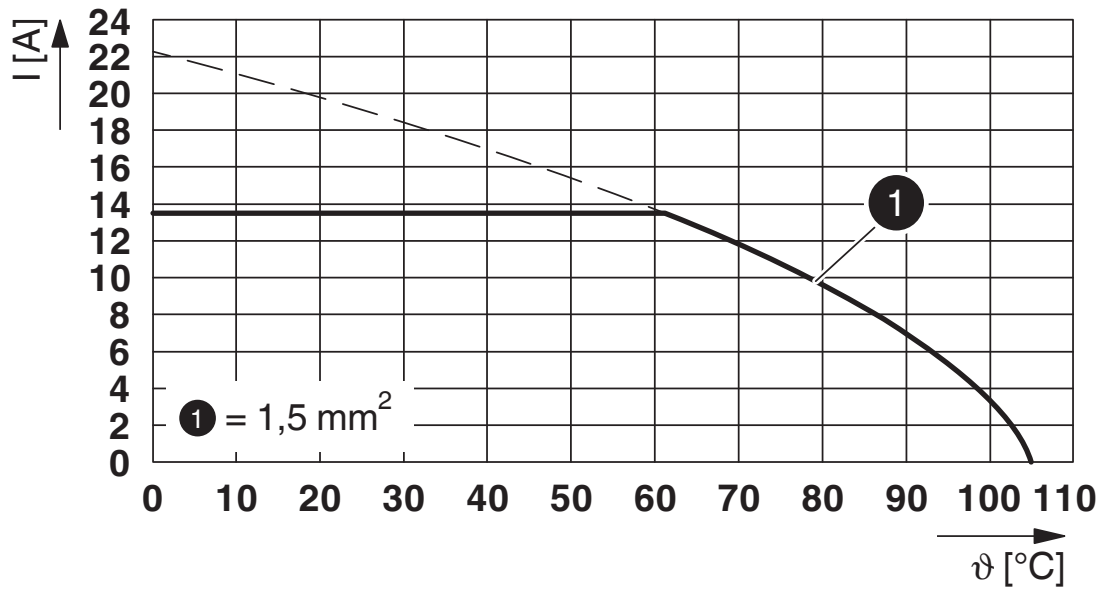

Type: MKKDSN 1,5/...

Dimensional drawing

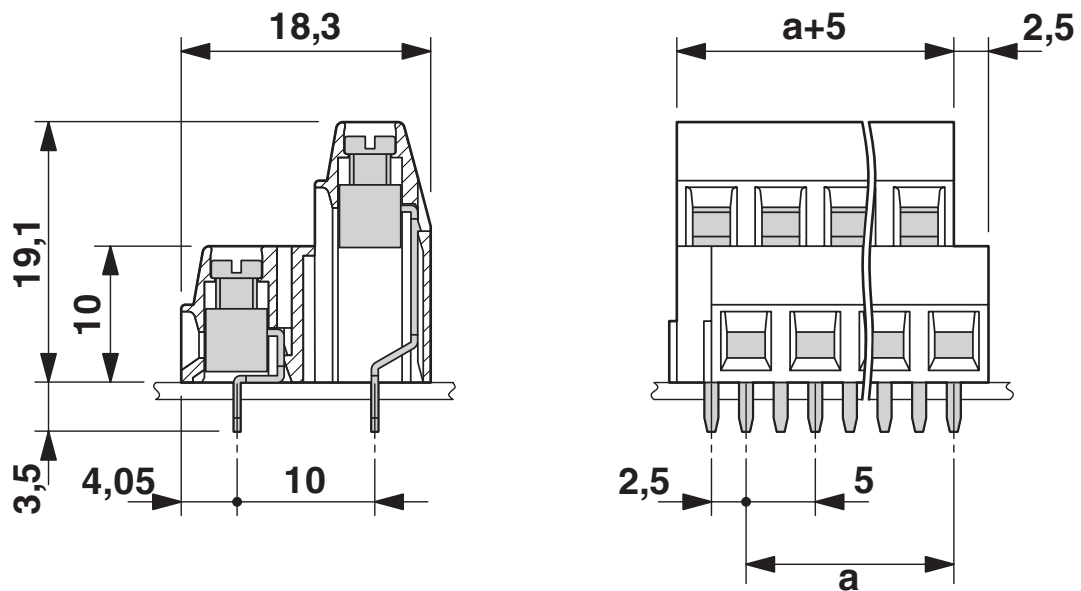

# MKKDSN 1,5/ 6 - PCB terminal block

1726134

<https://www.phoenixcontact.com/in/products/1726134>



Drilling plan/solder pad geometry

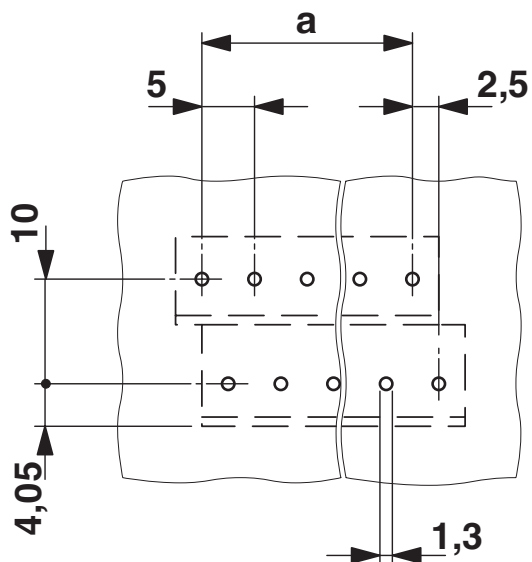

# MKKDSN 1,5/ 6 - PCB terminal block





1726134

<https://www.phoenixcontact.com/in/products/1726134>

## Approvals

 <b>CSA</b> Approval ID: 13631				
	Nominal Voltage $U_N$	Nominal Current $I_N$	Cross Section AWG	Cross Section $\text{mm}^2$
	150 V	10 A	28 - 14	-
	300 V	10 A	28 - 14	-

 <b>EAC</b> Approval ID: B.01687				
--	--	--	--	--

 <b>cULus Recognized</b> Approval ID: E60425-19770427				
	Nominal Voltage $U_N$	Nominal Current $I_N$	Cross Section AWG	Cross Section $\text{mm}^2$
	300 V	10 A	2x - 18	-
	300 V	10 A	30 - 14	-
	300 V	10 A	2x - 18	-
	300 V	10 A	30 - 14	-

 <b>IECEE CB Scheme</b> Approval ID: DE1-66542				
	Nominal Voltage $U_N$	Nominal Current $I_N$	Cross Section AWG	Cross Section $\text{mm}^2$
	400 V	13.5 A	-	0.2 - 1.5

 <b>VDE Zeichengenehmigung</b> Approval ID: 40055535				
	Nominal Voltage $U_N$	Nominal Current $I_N$	Cross Section AWG	Cross Section $\text{mm}^2$
	400 V	13.5 A	-	0.2 - 1.5



# MKKDSN 1,5/ 6 - PCB terminal block



1726134

<https://www.phoenixcontact.com/in/products/1726134>

## Classifications

### ECLASS

ECLASS-11.0	27460101
ECLASS-12.0	27460101
ECLASS-13.0	27460101

### ETIM

ETIM 8.0	EC002643
----------	----------

### UNSPSC

UNSPSC 21.0	39121400
-------------	----------

# MKKDSN 1,5/ 6 - PCB terminal block



1726134

<https://www.phoenixcontact.com/in/products/1726134>

## Environmental Product Compliance

REACH SVHC	Lead 7439-92-1
China RoHS	Environmentally Friendly Use Period = 50 years
	For information on hazardous substances, refer to the manufacturer's declaration available under "Downloads"

# MKKDSN 1,5/ 6 - PCB terminal block

1726134

<https://www.phoenixcontact.com/in/products/1726134>

## Accessories

 Note: Applying some accessories below might limit this product.

### EBP 2- 5 - Insertion bridge

1733169

<https://www.phoenixcontact.com/in/products/1733169>

Insertion bridge for connectors with 5.0 mm or 5.08 mm pitch



 Max. current carrying capacity: 12 A

### EBP 3- 5 - Insertion bridge

1733172

<https://www.phoenixcontact.com/in/products/1733172>

Insertion bridge for connectors with 5.0 mm or 5.08 mm pitch



 Max. current carrying capacity: 12 A

# MKKDSN 1,5/ 6 - PCB terminal block

1726134

<https://www.phoenixcontact.com/in/products/1726134>



## EBP 6- 5 - Insertion bridge

1733208

<https://www.phoenixcontact.com/in/products/1733208>

Insertion bridge for connectors with 5.0 mm or 5.08 mm pitch



 Max. current carrying capacity: 12 A

---

## SZS 0,6X3,5 - Screwdriver

1205053

<https://www.phoenixcontact.com/in/products/1205053>

Actuation tool, for ST terminal blocks, insulated, also suitable for use as a bladed screwdriver, size: 0.6 x 3.5 x 100 mm, 2-component grip, with non-slip grip



# MKKDSN 1,5/ 6 - PCB terminal block



1726134

<https://www.phoenixcontact.com/in/products/1726134>

## SK 5/3,8:FORTL.ZAHLEN - Marker card

0804183

<https://www.phoenixcontact.com/in/products/0804183>

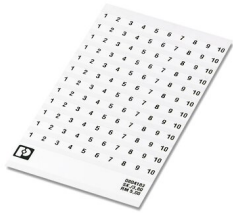

Marker card, white, labeled, horizontal: consecutive numbers 1 ... 10, 11 ... 20, etc. up to 91 ... (99)100, mounting type: adhesive, for terminal block width: 5 mm, lettering field size: 5 x 3.8 mm

## SK 5/3,8:UNBEDRUCKT - Marker card

0805409

<https://www.phoenixcontact.com/in/products/0805409>



Marker card, white, unlabeled, can be labeled with: Marker pen, mounting type: adhesive, for terminal block width: 5 mm, lettering field size: 5 x 3.8 mm

Phoenix Contact 2023 © - all rights reserved  
<https://www.phoenixcontact.com>

PHOENIX CONTACT (I) Pvt. Ltd.  
A-58/2, Okhla Industrial Area, Phase - II, New Delhi-110 020

+91.1275.71420  
[info@phoenixcontact.co.in](mailto:info@phoenixcontact.co.in)