

S10YBR-P07XCD0-0000
amc, type_s1

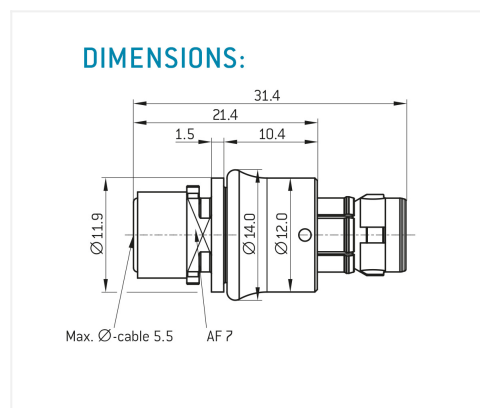

General information

Part number	S10YBR-P07XCD0-0000
Termination	solder
Size	0
Locking principle	push
Keying	b_key_amc
Cable Diameter	cable_amc_0
Cable outlet	overmolding

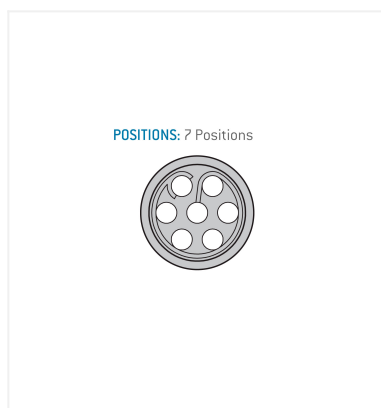
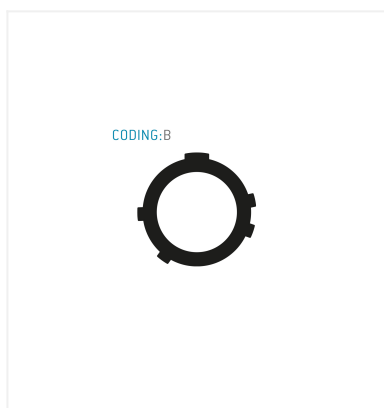

Contact insert description

Number of contacts	7
Contact type	pins
Contact diameter	05mm
Insulator material	peek
Wire cross section	26_awg
Termination	solder
Termination diameter	065mm

reverse_gender_on_request

Technical information

Nominal current single contact	05_a	iec_60512_5_2
Nominal current insert	3,25 A	vde_0298_4
Test voltage	09_kv_ac	eia_364_20f

safety_text

Mechanical and environmental data

Degree of protection*	ipsk8_ip6k9k
Operating temperature	51_125_c
Mating cycles	5000

mated

Material and surface treatments

Housing	ruthenium
Contact	cu_alloy_gold

safety_text_2
ul_text
illustrative_text