

# MSTBV 2,5/ 3-GF - PCB header



1776896

<https://www.phoenixcontact.com/in/products/1776896>

Please be informed that the data shown in this PDF document is generated from our Online Catalog. Please find the complete data in the user documentation. Our General Terms of Use for Downloads are valid.

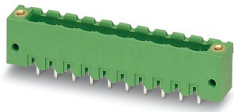

PCB headers, nominal cross section: 2.5 mm<sup>2</sup>, color: green, nominal current: 12 A, rated voltage (III/2): 320 V, contact surface: Tin, type of contact: Pin, number of potentials: 3, number of rows: 1, number of positions: 3, number of connections: 3, product range: MSTBV 2,5/...-GF, pitch: 5 mm, mounting: Wave soldering, pin layout: Linear pinning, solder pin [P]: 3.9 mm, number of solder pins per potential: 1, plug-in system: COMBICON MSTB 2,5, Pin connector pattern alignment: Standard, locking: Screw locking, mounting: Threaded flange, type of packaging: packed in cardboard

## Your advantages

- Maximum flexibility when it comes to device design – one header for connectors with different connection technologies
- Well-known mounting principle allows worldwide use
- Vertical connection enables multi-row arrangement on the PCB

## Commercial Data

Item number	1776896
Packing unit	250 pc
Minimum order quantity	250 pc
Sales Key	AAC
Product Key	AACSLC
Catalog Page	Page 317 (C-1-2013)
GTIN	4017918039066
Weight per Piece (including packing)	2.79 g
Weight per Piece (excluding packing)	2.556 g
Customs tariff number	85366930
Country of origin	DE

# MSTBV 2,5/ 3-GF - PCB header



1776896

<https://www.phoenixcontact.com/in/products/1776896>

## Technical Data

### Product properties

Type	Standard
Product line	COMBICON Connectors M
Product type	PCB headers
Product family	MSTBV 2,5/..-GF
Number of positions	3
Pitch	5 mm
Number of connections	3
Number of rows	1
Mounting flange	Threaded flange
Number of potentials	3
Pin layout	Linear pinning
Solder pins per potential	1

### Electrical properties

Nominal current $I_N$	12 A
Nominal voltage $U_N$	320 V
Degree of pollution	3
Contact resistance	2.4 m $\Omega$
Rated voltage (III/3)	250 V
Rated surge voltage (III/3)	4 kV
Rated voltage (III/2)	320 V
Rated surge voltage (III/2)	4 kV
Rated voltage (II/2)	400 V
Rated surge voltage (II/2)	4 kV

### Mounting

Mounting type	Wave soldering
Pin layout	Linear pinning

### Flange

Tightening torque	0.3 Nm
-------------------	--------

### Attachment on the PCB

Tightening torque	0.3 Nm
Screw	Sheet metal screw ISO 1481-ST 2,2x6,5 C or ISO 7049-ST 2,2x6,5 C

### Material specifications

#### Material data - contact

Note	WEEE/RoHS-compliant, free of whiskers according to IEC 60068-2-82/JEDEC JESD 201
------	--

# MSTBV 2,5/ 3-GF - PCB header

1776896

<https://www.phoenixcontact.com/in/products/1776896>

Contact material	Cu alloy
Surface characteristics	Tin-plated
Metal surface contact area (top layer)	Tin (3 - 5 µm Sn)
Metal surface contact area (middle layer)	Nickel (1.3 - 3 µm Ni)
Metal surface soldering area (top layer)	Tin (3 - 5 µm Sn)
Metal surface soldering area (middle layer)	Nickel (1.3 - 3 µm Ni)

## Material data - housing

Color (Housing)	green (6021)
Insulating material	PBT
Insulating material group	IIIa
CTI according to IEC 60112	225
Flammability rating according to UL 94	V0

## Material data – actuating element

Color ( )	( )
-----------	-----

## Notes

Notes on operation	In accordance with IEC 61984, COMBICON connectors have no switching power (COC). During designated use, they must not be plugged in or disconnected when carrying voltage or under load.
--------------------	--

## Dimensions

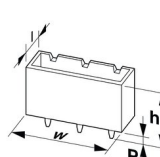
Dimensional drawing	
Pitch	5 mm
Width [w]	25 mm
Height [h]	15.9 mm
Length [l]	8.6 mm
Installed height	12 mm
Solder pin length [P]	3.9 mm

## Mechanical tests

### Test for conductor damage and slackening

Specification	IEC 60999-1:1999-11
Result	Test passed

### Pull-out test

Specification	IEC 60999-1:1999-11
Conductor cross section/conductor type/tractive force setpoint/actual value	0.2 mm <sup>2</sup> / solid / > 10 N
	0.2 mm <sup>2</sup> / flexible / > 10 N
	2.5 mm <sup>2</sup> / solid / > 50 N

# MSTBV 2,5/ 3-GF - PCB header



1776896

<https://www.phoenixcontact.com/in/products/1776896>

	2.5 mm <sup>2</sup> / flexible / > 50 N
--	---

## Insertion and withdrawal forces

Result	Test passed
No. of cycles	25
Insertion strength per pos. approx.	8 N
Withdraw strength per pos. approx.	6 N

## Torque test

Specification	IEC 60999-1:1999-11
---------------	---------------------

## Contact holder in insert

Specification	IEC 60512-15-1:2008-05
Contact holder in insert Requirements >20 N	Test passed

## Resistance of inscriptions

Specification	IEC 60068-2-70:1995-12
Result	Test passed

## Polarization and coding

Specification	IEC 60512-13-5:2006-02
Result	Test passed

## Visual inspection

Specification	IEC 60512-1-1:2002-02
Result	Test passed

## Dimension check

Specification	IEC 60512-1-2:2002-02
Result	Test passed

## Electrical tests

### Thermal test | Test group C

Specification	IEC 60512-5-1:2002-02
Tested number of positions	18

### Insulation resistance

Specification	IEC 60512-3-1:2002-02
Insulation resistance, neighboring positions	> 5 MΩ

### Air clearances and creepage distances |

Specification	IEC 60664-1:2007-04
Insulating material group	IIIa
Comparative tracking index (IEC 60112)	CTI 225
Rated insulation voltage (III/3)	250 V
Rated surge voltage (III/3)	4 kV
minimum clearance value - non-homogenous field (III/3)	3 mm

# MSTBV 2,5/ 3-GF - PCB header



1776896

<https://www.phoenixcontact.com/in/products/1776896>

minimum creepage distance (III/3)	4 mm
Rated insulation voltage (III/2)	320 V
Rated surge voltage (III/2)	4 kV
minimum clearance value - non-homogenous field (III/2)	3 mm
minimum creepage distance (III/2)	3.2 mm
Rated insulation voltage (II/2)	400 V
Rated surge voltage (II/2)	4 kV
minimum clearance value - non-homogenous field (II/2)	3 mm
minimum creepage distance (II/2)	4 mm

## Environmental and real-life conditions

### Vibration test

Specification	IEC 60068-2-6:2007-12
Frequency	10 - 150 - 10 Hz
Sweep speed	1 octave/min
Amplitude	0.35 mm (10 Hz ... 60.1 Hz)
Sweep speed	5g (60.1 Hz ... 150 Hz)
Test duration per axis	2.5 h

### Durability test

Specification	IEC 60512-9-1:2010-03
Impulse withstand voltage at sea level	4.8 kV
Contact resistance $R_1$	2.4 m $\Omega$
Contact resistance $R_2$	2.4 m $\Omega$
Insertion/withdrawal cycles	25
Insulation resistance, neighboring positions	> 5 M $\Omega$

### Climatic test

Specification	ISO 6988:1985-02
Corrosive stress	0.2 dm <sup>3</sup> SO <sub>2</sub> on 300 dm <sup>3</sup> /40 °C/1 cycle
Thermal stress	100 °C/168 h
Power-frequency withstand voltage	2.21 kV

### Ambient conditions

Ambient temperature (operation)	-40 °C ... 100 °C (dependent on the derating curve)
Ambient temperature (storage/transport)	-40 °C ... 70 °C
Relative humidity (storage/transport)	30 % ... 70 %
Ambient temperature (assembly)	-5 °C ... 100 °C

## Packaging specifications

Type of packaging	packed in cardboard
-------------------	---------------------

## Drawings

Diagram

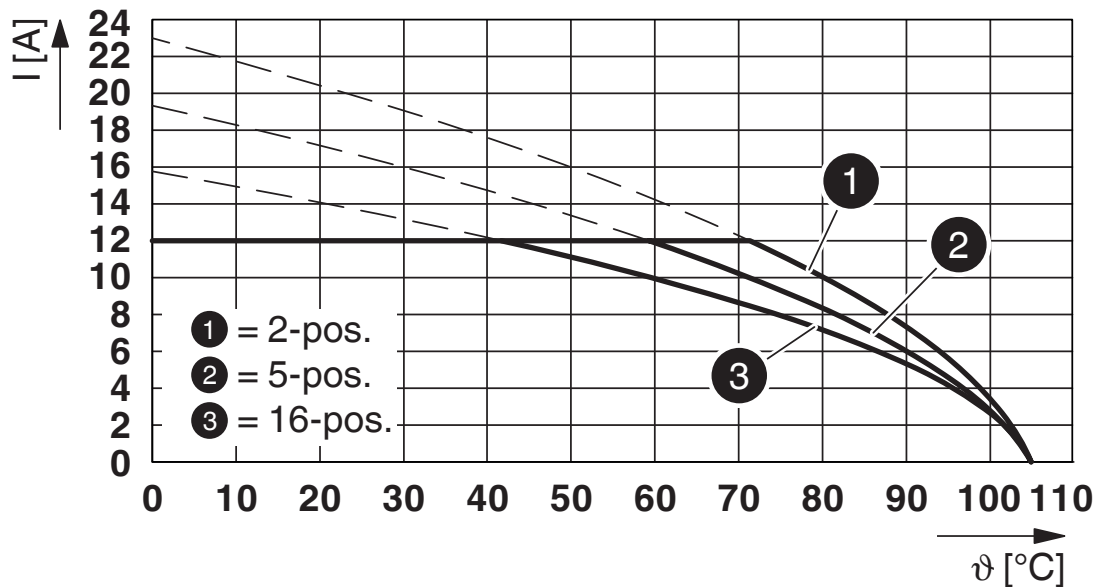

Type: FKCVW 2,5/...-STF with MSTBV 2,5/...-GF

Diagram

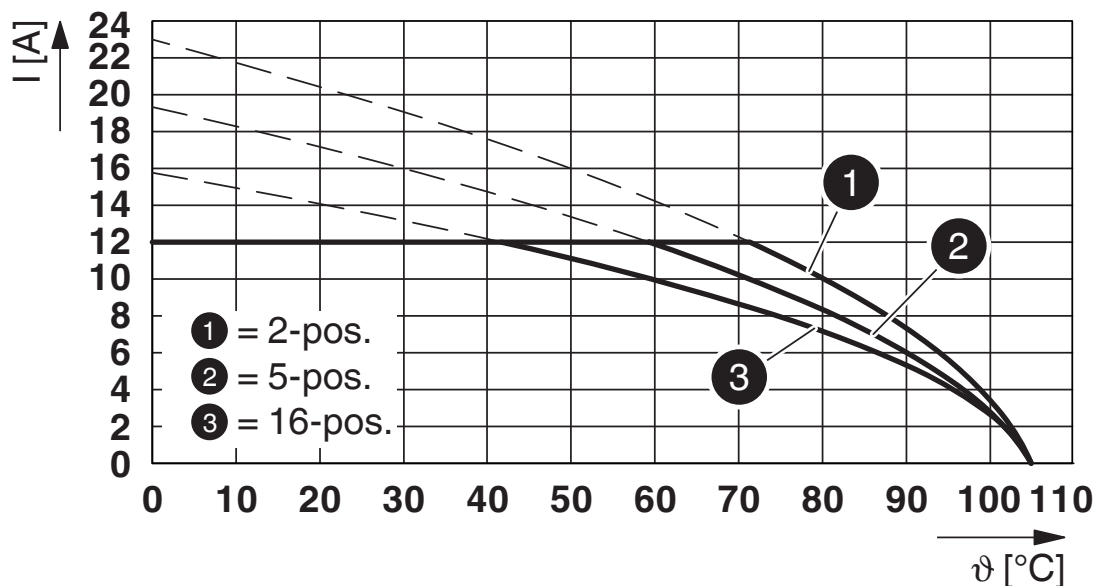

Type: FKCVR 2,5/...-STF with MSTBV 2,5/...-GF

# MSTBV 2,5/ 3-GF - PCB header

1776896

<https://www.phoenixcontact.com/in/products/1776896>

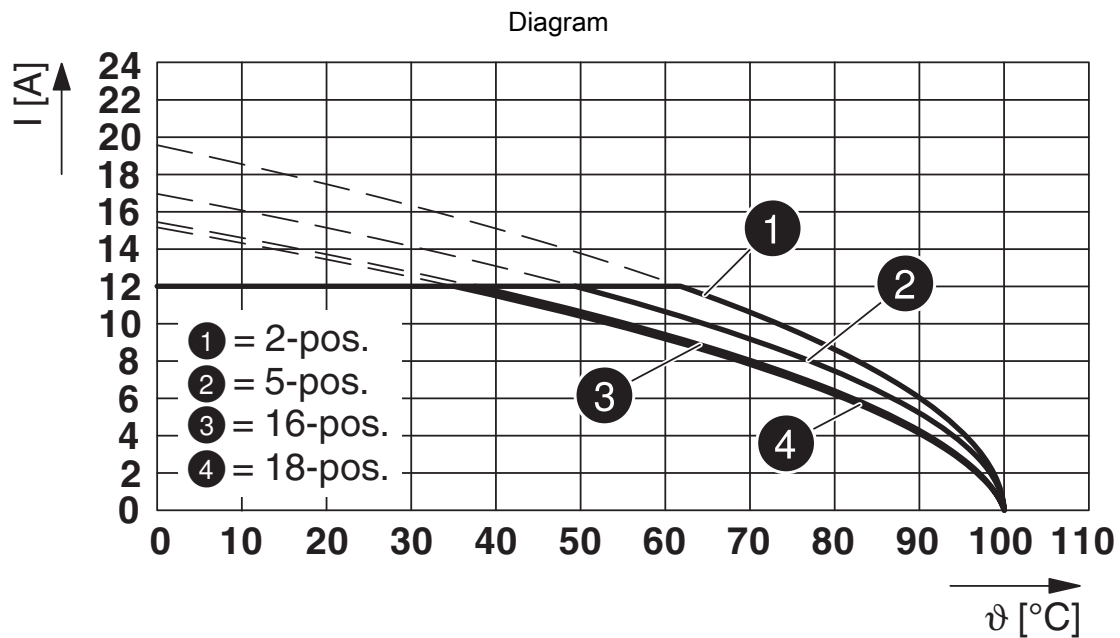

Type: FKCT 2,5/...-STF with MSTBV 2,5/...-GF

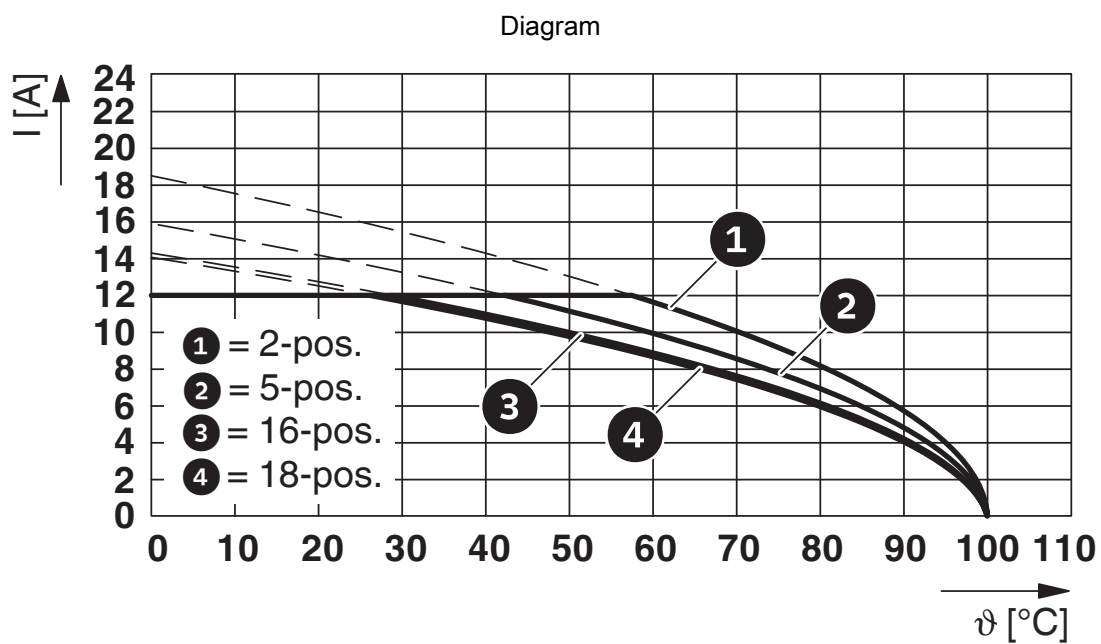

Type: MSTBT 2,5/...-STF with MSTBV 2,5/...-GF

# MSTBV 2,5/ 3-GF - PCB header



1776896

<https://www.phoenixcontact.com/in/products/1776896>

## Approvals

 <b>CSA</b> Approval ID: 13631				
	Nominal Voltage $U_N$	Nominal Current $I_N$	Cross Section AWG	Cross Section $\text{mm}^2$
	300 V	12 A	-	-
	300 V	10 A	-	-

 <b>IECEE CB Scheme</b> Approval ID: DE1-60988-B1B2				
	Nominal Voltage $U_N$	Nominal Current $I_N$	Cross Section AWG	Cross Section $\text{mm}^2$
	250 V	12 A	-	-

 <b>EAC</b> Approval ID: B.01687				
--	--	--	--	--

 <b>cULus Recognized</b> Approval ID: E60425-19931011				
	Nominal Voltage $U_N$	Nominal Current $I_N$	Cross Section AWG	Cross Section $\text{mm}^2$
	300 V	12 A	-	-
	300 V	10 A	-	-

 <b>DNV GL</b> Approval ID: TAE00001EY				
--	--	--	--	--

 <b>VDE Zeichengenehmigung</b> Approval ID: 40050648				
	Nominal Voltage $U_N$	Nominal Current $I_N$	Cross Section AWG	Cross Section $\text{mm}^2$
	250 V	12 A	-	-



# MSTBV 2,5/ 3-GF - PCB header



1776896

<https://www.phoenixcontact.com/in/products/1776896>

## Classifications

### ECLASS

ECLASS-11.0	27460201
ECLASS-12.0	27460201
ECLASS-13.0	27460201

### ETIM

ETIM 8.0	EC002637
----------	----------

### UNSPSC

UNSPSC 21.0	39121400
-------------	----------

# MSTBV 2,5/ 3-GF - PCB header

1776896

<https://www.phoenixcontact.com/in/products/1776896>



## Environmental Product Compliance

China RoHS	Environmentally friendly use period: unlimited = EFUP-e
	No hazardous substances above threshold values

# MSTBV 2,5/ 3-GF - PCB header

1776896

<https://www.phoenixcontact.com/in/products/1776896>



## Accessories

### CR-MSTB - Coding section

1734401

<https://www.phoenixcontact.com/in/products/1734401>

Coding section, inserted into the recess in the header or the inverted plug, red insulating material



---

### MSTB-BL - Accessories

1755477

<https://www.phoenixcontact.com/in/products/1755477>

Keying cap, for forming sections, plugs onto header pin, green insulating material



# MSTBV 2,5/ 3-GF - PCB header

1776896

<https://www.phoenixcontact.com/in/products/1776896>



## SK 5/3,8:FORTL.ZAHLEN - Marker card

0804183

<https://www.phoenixcontact.com/in/products/0804183>



Marker card, white, labeled, horizontal: consecutive numbers 1 ... 10, 11 ... 20, etc. up to 91 ... (99)100, mounting type: adhesive, for terminal block width: 5 mm, lettering field size: 5 x 3.8 mm

---

## SK 5/3,8:UNBEDRUCKT - Marker card

0805409

<https://www.phoenixcontact.com/in/products/0805409>



Marker card, white, unlabeled, can be labeled with: Marker pen, mounting type: adhesive, for terminal block width: 5 mm, lettering field size: 5 x 3.8 mm

# MSTBV 2,5/ 3-GF - PCB header

1776896

<https://www.phoenixcontact.com/in/products/1776896>



## QC 1,5/ 3-STF - PCB connector

1718122

<https://www.phoenixcontact.com/in/products/1718122>



PCB connector, nominal cross section: 1.5 mm<sup>2</sup>, color: green, nominal current: 12 A, rated voltage (III/2): 630 V, contact surface: Tin, type of contact: Socket, number of potentials: 3, number of rows: 1, number of positions: 3, number of connections: 3, product range: QC 1,5/..-STF, pitch: 5 mm, connection method: Displacement connection, conductor/PCB connection direction: 0 °, locking clip: - without locking clip, plug-in system: COMBICON MSTB 2,5, locking: Screw locking, mounting: Screw flange, type of packaging: packed in cardboard

---

## FKCN 2,5/ 3-STF - PCB connector

1732975

<https://www.phoenixcontact.com/in/products/1732975>

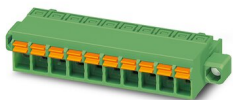

PCB connector, nominal cross section: 2.5 mm<sup>2</sup>, color: green, nominal current: 12 A, rated voltage (III/2): 320 V, contact surface: Tin, type of contact: Socket, number of potentials: 3, number of rows: 1, number of positions: 3, number of connections: 3, product range: FKCN 2,5/..-STF, pitch: 5 mm, connection method: Push-in spring connection, conductor/PCB connection direction: 0 °, locking clip: - Locking clip, plug-in system: COMBICON MSTB 2,5, locking: Screw locking, mounting: Screw flange, type of packaging: packed in cardboard

# MSTBV 2,5/ 3-GF - PCB header

1776896

<https://www.phoenixcontact.com/in/products/1776896>



## MVSTBW 2,5/ 3-STF - PCB connector

1835290

<https://www.phoenixcontact.com/in/products/1835290>

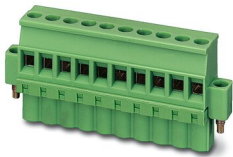

PCB connector, nominal cross section: 2.5 mm<sup>2</sup>, color: green, nominal current: 12 A, rated voltage (III/2): 320 V, contact surface: Tin, type of contact: Socket, number of potentials: 3, number of rows: 1, number of positions: 3, number of connections: 3, product range: MVSTBW 2,5/..-STF, pitch: 5 mm, connection method: Screw connection with tension sleeve, screw head form: L Slotted, conductor/PCB connection direction: -90 °, locking clip: - Locking clip, plug-in system: COMBICON MSTB 2,5, locking: Screw locking, mounting: Screw flange, type of packaging: packed in cardboard

---

## MVSTBR 2,5/ 3-STF - PCB connector

1835481

<https://www.phoenixcontact.com/in/products/1835481>

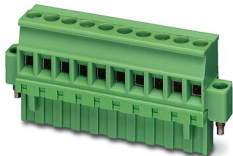

PCB connector, nominal cross section: 2.5 mm<sup>2</sup>, color: green, nominal current: 12 A, rated voltage (III/2): 320 V, contact surface: Tin, type of contact: Socket, number of potentials: 3, number of rows: 1, number of positions: 3, number of connections: 3, product range: MVSTBR 2,5/..-STF, pitch: 5 mm, connection method: Screw connection with tension sleeve, screw head form: L Slotted, conductor/PCB connection direction: 90 °, locking clip: - Locking clip, plug-in system: COMBICON MSTB 2,5, locking: Screw locking, mounting: Screw flange, type of packaging: packed in cardboard

# MSTBV 2,5/ 3-GF - PCB header

1776896

<https://www.phoenixcontact.com/in/products/1776896>



## FKCT 2,5/ 3-STF - PCB connector

1909414

<https://www.phoenixcontact.com/in/products/1909414>

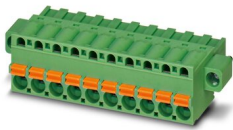

PCB connector, nominal cross section: 2.5 mm<sup>2</sup>, color: green, nominal current: 12 A, rated voltage (III/2): 320 V, contact surface: Tin, type of contact: Socket, number of potentials: 3, number of rows: 1, number of positions: 3, number of connections: 3, product range: FKCT 2,5/..-STF, pitch: 5 mm, connection method: Push-in spring connection, conductor/PCB connection direction: 0 °, locking clip: - without locking clip, plug-in system: COMBICON MSTB 2,5, locking: Screw locking, mounting: Screw flange, type of packaging: packed in cardboard

---

## FKCVR 2,5/ 3-STF - PCB connector

1909896

<https://www.phoenixcontact.com/in/products/1909896>

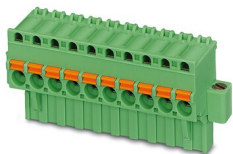

PCB connector, nominal cross section: 2.5 mm<sup>2</sup>, color: green, nominal current: 12 A, rated voltage (III/2): 320 V, contact surface: Tin, type of contact: Socket, number of potentials: 3, number of rows: 1, number of positions: 3, number of connections: 3, product range: FKCVR 2,5/..-STF, pitch: 5 mm, connection method: Push-in spring connection, conductor/PCB connection direction: 90 °, locking clip: - Locking clip, plug-in system: COMBICON MSTB 2,5, locking: Screw locking, mounting: Screw flange, type of packaging: packed in cardboard

# MSTBV 2,5/ 3-GF - PCB header

1776896

<https://www.phoenixcontact.com/in/products/1776896>



## FKCVW 2,5/ 3-STF - PCB connector

1910212

<https://www.phoenixcontact.com/in/products/1910212>

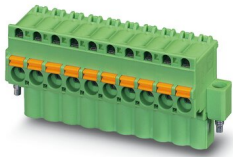

PCB connector, nominal cross section: 2.5 mm<sup>2</sup>, color: green, nominal current: 12 A, rated voltage (III/2): 320 V, contact surface: Tin, type of contact: Socket, number of potentials: 3, number of rows: 1, number of positions: 3, number of connections: 3, product range: FKCVW 2,5/..-STF, pitch: 5 mm, connection method: Push-in spring connection, conductor/PCB connection direction: -90 °, locking clip: - Locking clip, plug-in system: COMBICON MSTB 2,5, locking: Screw locking, mounting: Screw flange, type of packaging: packed in cardboard

---

## FKC 2,5/ 3-STF - PCB connector

1910539

<https://www.phoenixcontact.com/in/products/1910539>



PCB connector, nominal cross section: 2.5 mm<sup>2</sup>, color: green, nominal current: 12 A, rated voltage (III/2): 320 V, contact surface: Tin, type of contact: Socket, number of potentials: 3, number of rows: 1, number of positions: 3, number of connections: 3, product range: FKC 2,5/..-STF, pitch: 5 mm, connection method: Push-in spring connection, conductor/PCB connection direction: 0 °, locking clip: - Locking clip, plug-in system: COMBICON MSTB 2,5, locking: Screw locking, mounting: Screw flange, type of packaging: packed in cardboard



# MSTBV 2,5/ 3-GF - PCB header

1776896

<https://www.phoenixcontact.com/in/products/1776896>



## SMSTB 2,5/ 3-STF - PCB connector

1970883

<https://www.phoenixcontact.com/in/products/1970883>



PCB connector, nominal cross section: 2.5 mm<sup>2</sup>, color: green, nominal current: 12 A, rated voltage (III/2): 320 V, contact surface: Tin, type of contact: Socket, number of potentials: 3, number of rows: 1, number of positions: 3, number of connections: 3, product range: SMSTB 2,5/..-STF, pitch: 5 mm, connection method: Screw connection with tension sleeve, screw head form: L Slotted, conductor/PCB connection direction: -45 °, locking clip: - Locking clip, plug-in system: COMBICON MSTB 2,5, locking: Screw locking, mounting: Screw flange, type of packaging: packed in cardboard

---

Phoenix Contact 2023 © - all rights reserved

<https://www.phoenixcontact.com>

PHOENIX CONTACT (I) Pvt. Ltd.

A-58/2, Okhla Industrial Area, Phase - II, New Delhi-110 020

+91.1275.71420

[info@phoenixcontact.co.in](mailto:info@phoenixcontact.co.in)