

# MINI MCR-2-UNI-UI-2UI - Signal duplicator



2905026

<https://www.phoenixcontact.com/in/products/2905026>

Please be informed that the data shown in this PDF document is generated from our Online Catalog. Please find the complete data in the user documentation. Our General Terms of Use for Downloads are valid.



Universally configurable 4-way signal duplicator, with plug-in connection technology for the electrical isolation and duplication of analog signals. Configurable via DIP switch or software. Screw connection technology, standard configuration.

## Product Description

Configurable, freely adjustable 4-way signal duplicator with plug-in connection technology for the duplication, electrical isolation, conversion, amplification, and filtering of standard signals. Current signals between 0 mA ... 24 mA and voltage signals between 0 V ... 12 V can be processed on the input side. Signals between 0 mA ... 21 mA and 0 V ... 10.5 V are possible on the output side. Both output signals can be set independently of one another. The minimum measuring span is 1 mA and 0.5 V. Full accuracy is maintained with a measuring span greater than 10 mA and 5 V. You can configure the device using one of the free software solutions. Default settings can also be made directly on the device by simply using the DIP switches (see configuration table). The measuring transducer supports fault monitoring and NFC communication.

## Commercial Data

|                                      |                    |
|--------------------------------------|--------------------|
| Item number                          | 2905026            |
| Packing unit                         | 1 pc               |
| Minimum order quantity               | 1 pc               |
| Sales Key                            | CK1                |
| Product Key                          | CK1411             |
| Catalog Page                         | Page 70 (C-5-2019) |
| GTIN                                 | 4046356915243      |
| Weight per Piece (including packing) | 126.4 g            |
| Weight per Piece (excluding packing) | 120.4 g            |
| Customs tariff number                | 85437090           |
| Country of origin                    | DE                 |

## Technical Data

### Notes

#### Utilization restriction

|          |   |
|----------|---|
| EMC note | EMC: class A product, see manufacturer's declaration in the download area |
|----------|---|

### Product properties

|                 |                    |
|-----------------|--------------------|
| Product type    | Signal duplicator  |
| Product family  | MINI Analog Pro    |
| No. of channels | 2                  |
| Type            | Signal conditioner |
| Configuration   | DIP switches       |
|                 | Software           |
|                 | App                |

#### Insulation characteristics: GB Standard

|                      |    |
|----------------------|----|
| Overvoltage category | II |
| Pollution degree     | 2  |

### System properties

#### Functionality

|               |              |
|---------------|--------------|
| Configuration | DIP switches |
|               | Software     |
|               | App          |

### Electrical properties

|                                 |  |
|---------------------------------|--|
| No. of channels                 | 2  |
| Electrical isolation            | 4-way isolation  |
| Step response (0–99%)           | 140 ms (15 Hz sample rate)                               |
|                                 | 45 ms (60 Hz sample rate)                                |
|                                 | 25 ms (240 Hz sample rate, can only be set via software) |
| Maximum temperature coefficient | 0.01 %/K   |
| Maximum transmission error      | 0.05 % (of final value)                                  |

#### Electrical isolation Input/output/power supply

|                          |   |
|--------------------------|---|
| Rated insulation voltage | 300 V <sub>rms</sub>                              |
| Test voltage             | 3 kV AC (50 Hz, 60 s)                             |
| Insulation               | Reinforced insulation according to IEC/EN 61010-1 |

#### Supply

|                        |         |
|------------------------|---------|
| Nominal supply voltage | 24 V DC |
|------------------------|---------|

# MINI MCR-2-UNI-UI-2UI - Signal duplicator



2905026

<https://www.phoenixcontact.com/in/products/2905026>

|                             |  |
|-----------------------------|--|
| Supply voltage range        | 9.6 V DC ... 30 V DC (The DIN rail connector (ME 6,2 TBUS-2 1,5/5-ST-3,81 GN, item no. 2869728) can be used to bridge the supply voltage. It can be snapped onto a 35 mm DIN rail in accordance with EN 60715) |
| Typical current consumption | 55 mA (24 V DC)  |
|                             | 110 mA (12 V DC)   |
| Power consumption           | 1.5 W (at $I_{OUT} = 20$ mA, 9.6 V DC, 600 $\Omega$ load)  |

## Input data

Signal: Voltage/current

|                                   |   |
|-----------------------------------|---|
| Number of inputs                  | 1   |
| Configurable/programmable         | Yes   |
| Voltage input signal              | 0 V ... 10 V (via DIP switch)               |
|                                   | 2 V ... 10 V (via DIP switch)               |
|                                   | 0 V ... 5 V (via DIP switch)                |
|                                   | 1 V ... 5 V (via DIP switch)                |
|                                   | 0 V ... 12 V (can be set via software)      |
| Max. voltage input signal         | 12 V  |
| Current input signal              | 0 mA ... 20 mA (via DIP switch)             |
|                                   | 4 mA ... 20 mA (via DIP switch)             |
|                                   | 0 mA ... 10 mA (via DIP switch)             |
|                                   | 20 mA ... 0 mA (via DIP switch)             |
|                                   | 0 mA ... 24 mA (can be set via software)    |
| Minimum current input signal      | freely configurable                         |
| Max. current input signal         | 24 mA                                       |
| Input resistance of voltage input | > 120 k $\Omega$                            |
| Input resistance current input    | approx. 50 $\Omega$ (+0.7 V for test diode) |

## Output data

Signal: Voltage/current

|                            |  |
|----------------------------|--|
| Number of outputs          | 2  |
| Voltage output signal      | 0 V ... 10 V (via DIP switch)            |
|                            | 2 V ... 10 V (via DIP switch)            |
|                            | 0 V ... 5 V (via DIP switch)             |
|                            | 1 V ... 5 V (via DIP switch)             |
|                            | 0 V ... 10.5 V (can be set via software) |
| Max. voltage output signal | approx. 12.3 V                           |
| Non-load voltage           | $\leq 18.5$ V                            |
| Current output signal      | 0 mA ... 20 mA (via DIP switch)          |
|                            | 4 mA ... 20 mA (via DIP switch)          |
|                            | 0 mA ... 10 mA (via DIP switch)          |
|                            | 20 mA ... 0 mA (via DIP switch)          |
|                            | 0 mA ... 21 mA (can be set via software) |
| Max. current output signal | 24.6 mA                                  |

# MINI MCR-2-UNI-UI-2UI - Signal duplicator



2905026

<https://www.phoenixcontact.com/in/products/2905026>

|                                 |  |
|---------------------------------|--|
| Short-circuit current           | ≤ 25 mA  |
| Load/output load voltage output | ≥ 10 kΩ  |
| Load/output load current output | ≤ 600 Ω (per channel)  |
| Ripple                          | < 20 mV <sub>PP</sub> (at 600 Ω)<br>< 20 mV <sub>PP</sub> (at 600 Ω) |

## Connection data

|                                  |  |
|----------------------------------|--|
| Connection method                | Screw connection   |
| Stripping length                 | 10 mm  |
| Screw thread                     | M3   |
| Conductor cross section rigid    | 0.2 mm <sup>2</sup> ... 1.5 mm <sup>2</sup> (with ferrule)<br>0.14 mm <sup>2</sup> ... 2.5 mm <sup>2</sup> (without ferrule) |
| Conductor cross section flexible | 0.14 mm <sup>2</sup> ... 2.5 mm <sup>2</sup>   |
| Conductor cross section AWG      | 24 ... 12 (flexible)   |
| Tightening torque                | 0.5 Nm ... 0.6 Nm  |

## Ex data

|                       |              |
|-----------------------|--------------|
| Ex installation (EPL) | Gc<br>Div. 2 |
|-----------------------|--------------|

## Interfaces

Data: IFS interface

|                   |                  |
|-------------------|------------------|
| Connection method | Micro USB type B |
|-------------------|------------------|

## Signaling

|                  |                            |
|------------------|----------------------------|
| Status display   | Green LED (supply voltage) |
| Error indication | Red LED                    |

## Dimensions

|        |           |
|--------|-----------|
| Width  | 6.2 mm    |
| Height | 109.81 mm |
| Depth  | 119.2 mm  |

## Material specifications

|  |             |
|--|-------------|
| Fire protection for rail vehicles (DIN EN 45545-2) R22 | HL 1 - HL 2 |
| Fire protection for rail vehicles (DIN EN 45545-2) R23 | HL 1 - HL 2 |
| Fire protection for rail vehicles (DIN EN 45545-2) R24 | HL 1 - HL 2 |
| Housing material                                       | PBT         |

## Environmental and real-life conditions

Ambient conditions

|   |                           |
|---|---------------------------|
| Degree of protection                    | IP20 (not assessed by UL) |
| Ambient temperature (operation)         | -40 °C ... 70 °C          |
| Ambient temperature (storage/transport) | -40 °C ... 85 °C          |

# MINI MCR-2-UNI-UI-2UI - Signal duplicator



2905026

<https://www.phoenixcontact.com/in/products/2905026>

|                                  |                               |
|----------------------------------|-------------------------------|
| Altitude                         | ≤ 2000 m                      |
| Permissible humidity (operation) | 5 % ... 95 % (non-condensing) |

## Approvals

### CE

|             |              |
|-------------|--------------|
| Certificate | CE-compliant |
|-------------|--------------|

### ATEX

|                |   |
|----------------|---|
| Identification | <input type="checkbox"/> II 3 G Ex ec IIC T4 Gc |
| Certificate    | BVS 19 ATEX E 083 X                             |

### UKCA Ex (UKEX)

|                |   |
|----------------|---|
| Identification | <input type="checkbox"/> II 3 G Ex ec IIC T4 Gc |
| Certificate    | PxCIF21UKEX2905026X                             |

### IECEX

|                |                    |
|----------------|--------------------|
| Identification | Ex ec IIC T4 Gc    |
| Certificate    | IECEX BVS 19.0072X |

### CCC / China-Ex

|                |                   |
|----------------|-------------------|
| Identification | Ex nA IIC T4 Gc   |
| Certificate    | NEPSI GYJ20.1318X |

### UL, USA/Canada

|                |                                       |
|----------------|---------------------------------------|
| Identification | UL 508 Listed                         |
|                | Class I, Div. 2, Groups A, B, C, D T6 |
|                | Class I, Zone 2, Group IIC T6         |

### Shipbuilding approval

|             |                          |
|-------------|--------------------------|
| Certificate | DNV GL TAA000021E Rev. 1 |
|-------------|--------------------------|

### EAC Ex

|                |   |
|----------------|---|
| Identification | <input type="checkbox"/> 2Ex ec IIC T4 Gc |
| Certificate    | BY/112 02.01 TP012 103.01 00081           |

### DNV GL data

|             |   |
|-------------|---|
| Temperature | B   |
| Humidity    | B   |
| Vibration   | A   |
| EMC         | A   |
| Enclosure   | Required protection according to the Rules shall be provided upon installation on board |

## EMC data

|                               |  |
|-------------------------------|--|
| Noise immunity                | EN 61000-6-2   |
| Note                          | When being exposed to interference, there may be minimal deviations. |
| Electromagnetic compatibility | Conformance with EMC directive                                       |

# MINI MCR-2-UNI-UI-2UI - Signal duplicator



2905026

<https://www.phoenixcontact.com/in/products/2905026>

|                |              |
|----------------|--------------|
| Noise emission | EN 61000-6-4 |
|----------------|--------------|

## Electrostatic discharge

|                       |              |
|-----------------------|--------------|
| Standards/regulations | EN 61000-4-2 |
|-----------------------|--------------|

## Electrostatic discharge

|          |   |
|----------|---|
| Comments | Safety measures must be taken to prevent electrostatic discharge. |
|----------|---|

## Electromagnetic HF field

|  |                          |
|--|--------------------------|
| Designation  | Electromagnetic RF field |
| Standards/regulations                                  | EN 61000-4-3             |
| Typical deviation from the measuring range final value | 0.2 %                    |

## Fast transients (burst)

|  |                         |
|--|-------------------------|
| Designation  | Fast transients (burst) |
| Standards/regulations                                  | EN 61000-4-4            |
| Typical deviation from the measuring range final value | 0.1 %                   |

## Surge current load (surge)

|                       |              |
|-----------------------|--------------|
| Standards/regulations | EN 61000-4-5 |
|-----------------------|--------------|

## Conducted interference

|  |                         |
|--|-------------------------|
| Designation  | Conducted interferences |
| Standards/regulations                                  | EN 61000-4-6            |
| Typical deviation from the measuring range final value | 2.8 %                   |

## Standards and regulations

|                      |                 |
|----------------------|-----------------|
| Electrical isolation | 4-way isolation |
|----------------------|-----------------|

## GB Standard

|                       |           |
|-----------------------|-----------|
| Standards/regulations | GB 3836.1 |
|                       | GB 3836.8 |

## Mounting

|                       |   |
|-----------------------|---|
| Mounting type         | DIN rail mounting   |
| Assembly instructions | The DIN rail connector can be used for bridging the supply voltage. It can be snapped onto a 35 mm EN 60715 DIN rail. |
| Mounting position     | any   |

# MINI MCR-2-UNI-UI-2UI - Signal duplicator

2905026

<https://www.phoenixcontact.com/in/products/2905026>

## Drawings

Block diagram

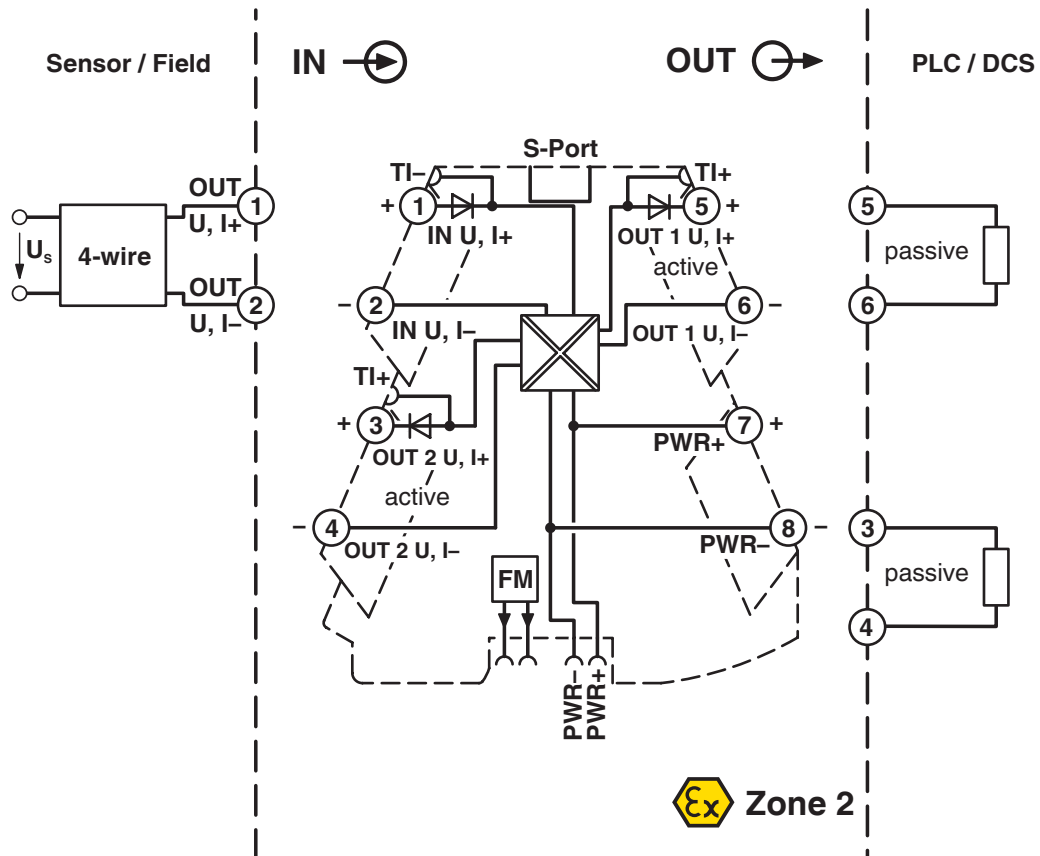

# MINI MCR-2-UNI-UI-2UI - Signal duplicator



2905026

<https://www.phoenixcontact.com/in/products/2905026>

## Approvals



**EAC**

Approval ID: RU\*DE.\*08.B.01536/19



**DNV GL**

Approval ID: TAA000021E



**UL Listed**

Approval ID: FILE E 238705



**cUL Listed**

Approval ID: FILE E 238705



**CCC**

Approval ID: 2021322310003879



**IECEx**

Approval ID: IECEx BVS 19.0072X



**cUL Listed**

Approval ID: FILE E 196811



**UL Listed**

Approval ID: FILE E 196811



**ATEX**

Approval ID: BVS 19 ATEX E 083 X



# MINI MCR-2-UNI-UI-2UI - Signal duplicator



2905026

<https://www.phoenixcontact.com/in/products/2905026>

## Classifications

### ECLASS

|             |          |
|-------------|----------|
| ECLASS-11.0 | 27210120 |
| ECLASS-12.0 | 27210120 |
| ECLASS-13.0 | 27210120 |

### ETIM

|          |          |
|----------|----------|
| ETIM 8.0 | EC002653 |
|----------|----------|

### UNSPSC

|             |          |
|-------------|----------|
| UNSPSC 21.0 | 39121000 |
|-------------|----------|

# MINI MCR-2-UNI-UI-2UI - Signal duplicator



2905026

<https://www.phoenixcontact.com/in/products/2905026>

## Environmental Product Compliance

|            |  |
|------------|--|
| REACH SVHC | Lead 7439-92-1   |
| China RoHS | Environmentally Friendly Use Period = 50 years   |
|            | For information on hazardous substances, refer to the manufacturer's declaration available under "Downloads" |

# MINI MCR-2-UNI-UI-2UI - Signal duplicator



2905026

<https://www.phoenixcontact.com/in/products/2905026>

## Accessories

### TC-D37SUB-AIO16-MP-PS-UNI - Module carrier

2906640

<https://www.phoenixcontact.com/in/products/2906640>

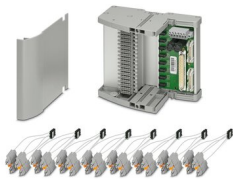

Universal Termination Carrier for connecting 16 MINI Analog Pro signal conditioners to digital or analog I/O cards, via D-SUB connector, 37-pos. (1:1 connection), with HART multiplexer connection

---

### TC-D37SUB-ADIO16-MP-P-UNI - Module carrier

2906639

<https://www.phoenixcontact.com/in/products/2906639>



Universal Termination Carrier for connecting 16 MINI Analog Pro signal conditioners to digital or analog I/O cards, via D-SUB connector, 37-pos. (1:1 connection)

# MINI MCR-2-UNI-UI-2UI - Signal duplicator

2905026

<https://www.phoenixcontact.com/in/products/2905026>



## ME 6,2 TBUS-2 1,5/5-ST-3,81 GY - DIN rail bus connectors

2695439

<https://www.phoenixcontact.com/in/products/2695439>

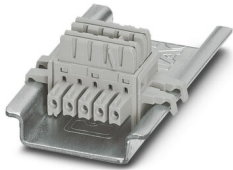

DIN rail connector (TBUS), 5-pos., for bridging the supply voltage, can be snapped onto NS 35/... DIN rail in accordance with EN 60715

---

## QUINT4-SYS-PS/1AC/24DC/2.5/SC - Power supply unit

2904614

<https://www.phoenixcontact.com/in/products/2904614>



Primary-switched power supply, QUINT POWER, screw connection, DIN rail mounting, supply of devices possible via the TBUS DIN rail connector, protective coating, input: single-phase, output: 24 V DC/2.5 A

## MINI MCR-2-UNI-UI-2UI - Signal duplicator

2905026

<https://www.phoenixcontact.com/in/products/2905026>



## ME 6,2 TBUS-2 1,5/5-ST-3,81 GN - DIN rail bus connectors

2869728

<https://www.phoenixcontact.com/in/products/2869728>

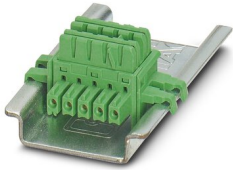

DIN rail connector for DIN rail mounting. Universal for TBUS housing. Gold-plated contacts, 5-pos.

---

## MINI MCR-2-PTB - Power terminal block

2902066

<https://www.phoenixcontact.com/in/products/2902066>



Power terminal with plug-in connection technology for delivering the supply voltage to the DIN rail connector. Monitoring of the supply voltages in combination with the fault monitoring module. Screw connection technology

# MINI MCR-2-UNI-UI-2UI - Signal duplicator

2905026

<https://www.phoenixcontact.com/in/products/2905026>

## MINI MCR-2-PTB-PT - Power terminal block

2902067

<https://www.phoenixcontact.com/in/products/2902067>



Power terminal with plug-in connection technology for delivering the supply voltage to the DIN rail connector. Monitoring of the supply voltages in combination with the fault monitoring module. Push-in connection technology

---

## MINI MCR-2-FM-RC - Monitoring module

2904504

<https://www.phoenixcontact.com/in/products/2904504>



Fault monitoring module with plug-in connection technology for evaluating and reporting group errors from the FM system and for monitoring the supply voltages. Error message via N/C contact. Screw connection technology, standard configuration

## MINI MCR-2-UNI-UI-2UI - Signal duplicator

2905026

<https://www.phoenixcontact.com/in/products/2905026>



## MINI MCR-2-FM-RC-PT - Monitoring module

2904508

<https://www.phoenixcontact.com/in/products/2904508>



Fault monitoring module with plug-in connection technology for evaluating and reporting group errors from the FM system and for monitoring the supply voltages. Error message via N/C contact. Push-in connection technology, standard configuration

---

## MINI MCR-2-V8-FLK 16 - System adapter

2901993

<https://www.phoenixcontact.com/in/products/2901993>



Eight MINI Analog Pro signal conditioners and measuring transducers can be connected to a controller with minimal cabling effort and without any errors using system adapters and system cabling.

# MINI MCR-2-UNI-UI-2UI - Signal duplicator

2905026

<https://www.phoenixcontact.com/in/products/2905026>



## MINI MCR-2-V8-MOD-RTU - Communication module

2905634

<https://www.phoenixcontact.com/in/products/2905634>

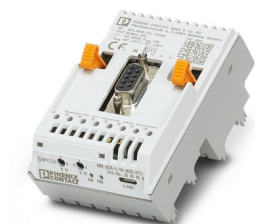

Eight MINI Analog Pro signal conditioners and measuring transducers are quickly and easily integrated into a Modbus/RTU network via a communication adapter.

---

## MINI MCR-2-V8-MOD-TCP - Communication module

2905635

<https://www.phoenixcontact.com/in/products/2905635>



Eight MINI Analog Pro signal conditioners and measuring transducers are quickly and easily integrated into a Modbus/TCP network via a communication adapter.



# MINI MCR-2-UNI-UI-2UI - Signal duplicator

2905026

<https://www.phoenixcontact.com/in/products/2905026>



## MINI MCR-2-V8-PB-DP - Communication module

2905636

<https://www.phoenixcontact.com/in/products/2905636>



Eight MINI Analog Pro signal conditioners and measuring transducers are quickly and easily integrated into a PROFIBUS DP network via a communication adapter.

---

## MINI MCR-2-V8-PN - Communication module

2905637

<https://www.phoenixcontact.com/in/products/2905637>



Eight MINI Analog Pro signal conditioners and measuring transducers can be quickly and easily integrated into a PROFINET network via a communication adapter.

# MINI MCR-2-UNI-UI-2UI - Signal duplicator



2905026

<https://www.phoenixcontact.com/in/products/2905026>

## IFS-USB-PROG-ADAPTER - Programming adapter

2811271

<https://www.phoenixcontact.com/in/products/2811271>



Programming adapter with USB interface, for programming with software. The USB driver is included in the software solutions for the products to be programmed, such as measuring transducers or motor managers.

---

## IFS-BT-PROG-ADAPTER - Adapter

2905872

<https://www.phoenixcontact.com/in/products/2905872>



Bluetooth adapter with micro USB and S-PORT interface for wireless communication with the MINI Analog, MINI Analog Pro, MACX Analog, Interface System Gateways, and PLC logic device series.

## MINI MCR-2-UNI-UI-2UI - Signal duplicator

2905026

<https://www.phoenixcontact.com/in/products/2905026>



## TWN4 MIFARE NFC USB ADAPTER - Programming adapter

2909681

<https://www.phoenixcontact.com/in/products/2909681>



Near Field Communication (NFC) programming adapter with USB interface for the wireless configuration of NFC-capable products from Phoenix Contact with software. A separate USB driver is not required.

---

## FASTCON PRO-SET - Connector set

2906227

<https://www.phoenixcontact.com/in/products/2906227>



FASTCON Pro plug set consisting of four plugs with screw connection, one for each position on the module. Suitable for all MINI Analog Pro modules.

# MINI MCR-2-UNI-UI-2UI - Signal duplicator

2905026

<https://www.phoenixcontact.com/in/products/2905026>

## FASTCON PRO-SET-PT - Connector set

2906228

<https://www.phoenixcontact.com/in/products/2906228>



FASTCON Pro plug set consisting of four plugs with push-in connection, one for each position on the module. Suitable for all MINI Analog Pro modules.

---

## UCT-EM (30X5) - Marker for end clamp

0801505

<https://www.phoenixcontact.com/in/products/0801505>



Marker for end clamp, Sheet, white, unlabeled, can be labeled with: TOPMARK NEO, TOPMARK LASER, BLUEMARK ID COLOR, BLUEMARK ID, BLUEMARK CLED, THERMOMARK PRIME, THERMOMARK CARD 2.0, THERMOMARK CARD, mounting type: snapped, lettering field size: 30 x 5 mm, Number of individual labels: 24

# MINI MCR-2-UNI-UI-2UI - Signal duplicator



2905026

<https://www.phoenixcontact.com/in/products/2905026>

## UCT-EM (30X5) CUS - Marker for end clamp

0801589

<https://www.phoenixcontact.com/in/products/0801589>



Marker for end clamp, can be ordered: by sheet, white, labeled according to customer specifications, mounting type: snapped into marker carrier, lettering field size: 30 x 5 mm, Number of individual labels: 24

---

## SK 5,0 WH:REEL - Marker strip

0805221

<https://www.phoenixcontact.com/in/products/0805221>



Marker strip, Roll, white, unlabeled, can be labeled with: THERMOMARK E.300 (D)/600 (D), THERMOMARK ROLL 2.0, THERMOMARK ROLL, THERMOMARK ROLL X1, THERMOMARK ROLLMASTER 300/600, THERMOMARK X1.2, mounting type: adhesive, for terminal block width: 5 mm, lettering field size: continuous x 5 mm, Number of individual labels: 90000

# MINI MCR-2-UNI-UI-2UI - Signal duplicator



2905026

<https://www.phoenixcontact.com/in/products/2905026>

## UC-EMLP (15X5) - Plastic label

0819301

<https://www.phoenixcontact.com/in/products/0819301>



Plastic label, Sheet, white, unlabeled, can be labeled with: BLUEMARK ID COLOR, BLUEMARK ID, BLUEMARK CLED, PLOTMARK, CMS-P1-PLOTTER, mounting type: adhesive, lettering field size: 15 x 5 mm, Number of individual labels: 10

---

## UC-EMLP (15X5) YE - Plastic label

0822615

<https://www.phoenixcontact.com/in/products/0822615>

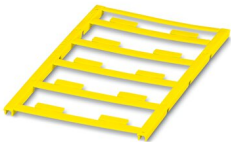

Plastic label, Sheet, yellow, unlabeled, can be labeled with: BLUEMARK ID COLOR, BLUEMARK ID, BLUEMARK CLED, PLOTMARK, CMS-P1-PLOTTER, mounting type: adhesive, lettering field size: 15 x 5 mm, Number of individual labels: 10

# MINI MCR-2-UNI-UI-2UI - Signal duplicator



2905026

<https://www.phoenixcontact.com/in/products/2905026>

## UC-EMLP (15X5) CUS - Plastic label

0824550

<https://www.phoenixcontact.com/in/products/0824550>

Plastic label, can be ordered: by sheet, white, labeled according to customer specifications, mounting type: adhesive, lettering field size: 15 x 5 mm



---

## UC-EMLP (15X5) YE CUS - Plastic label

0824551

<https://www.phoenixcontact.com/in/products/0824551>

Plastic label, can be ordered: by sheet, yellow, labeled according to customer specifications, mounting type: adhesive, lettering field size: 15 x 5 mm

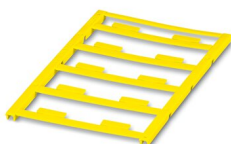

# MINI MCR-2-UNI-UI-2UI - Signal duplicator



2905026

<https://www.phoenixcontact.com/in/products/2905026>

## UC-EMLP (15X5) SR - Plastic label

0828095

<https://www.phoenixcontact.com/in/products/0828095>

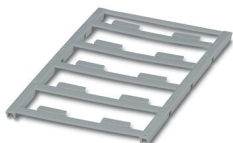

Plastic label, Sheet, silver, unlabeled, can be labeled with: BLUEMARK ID COLOR, BLUEMARK ID, BLUEMARK CLED, PLOTMARK, CMS-P1-PLOTTER, mounting type: adhesive, lettering field size: 15 x 5 mm, Number of individual labels: 10

---

## UC-EMLP (15X5) SR CUS - Plastic label

0828099

<https://www.phoenixcontact.com/in/products/0828099>

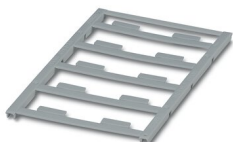

Plastic label, can be ordered: by sheet, silver, labeled according to customer specifications, mounting type: adhesive, lettering field size: 15 x 5 mm, Number of individual labels: 10



# MINI MCR-2-UNI-UI-2UI - Signal duplicator



2905026

<https://www.phoenixcontact.com/in/products/2905026>

## US-EMLP (15X5) - Plastic label

0828790

<https://www.phoenixcontact.com/in/products/0828790>



Plastic label, Card, white, unlabeled, can be labeled with: BLUEMARK ID COLOR, BLUEMARK ID, THERMOMARK PRIME, THERMOMARK CARD 2.0, THERMOMARK CARD, mounting type: adhesive, lettering field size: 15 x 5 mm, Number of individual labels: 189

---

## US-EMLP (15X5) YE - Plastic label

0828873

<https://www.phoenixcontact.com/in/products/0828873>



Plastic label, Card, yellow, unlabeled, can be labeled with: BLUEMARK ID COLOR, BLUEMARK ID, THERMOMARK PRIME, THERMOMARK CARD 2.0, THERMOMARK CARD, mounting type: adhesive, lettering field size: 15 x 5 mm, Number of individual labels: 189

# MINI MCR-2-UNI-UI-2UI - Signal duplicator



2905026

<https://www.phoenixcontact.com/in/products/2905026>

## US-EMLP (15X5) SR - Plastic label

0828874

<https://www.phoenixcontact.com/in/products/0828874>



Plastic label, Card, silver, unlabeled, can be labeled with: BLUEMARK ID COLOR, BLUEMARK ID, THERMOMARK PRIME, THERMOMARK CARD 2.0, THERMOMARK CARD, mounting type: adhesive, lettering field size: 15 x 5 mm, Number of individual labels: 189

---

## US-EMLP (15X5) CUS - Plastic label

0830076

<https://www.phoenixcontact.com/in/products/0830076>



Plastic label, can be ordered: by card, white, labeled according to customer specifications, mounting type: adhesive, lettering field size: 15 x 5 mm, Number of individual labels: 189

# MINI MCR-2-UNI-UI-2UI - Signal duplicator



2905026

<https://www.phoenixcontact.com/in/products/2905026>

## US-EMLP (15X5) YE CUS - Plastic label

0830077

<https://www.phoenixcontact.com/in/products/0830077>

Plastic label, can be ordered: by card, yellow, labeled according to customer specifications, mounting type: adhesive, lettering field size: 15 x 5 mm, Number of individual labels: 189



---

## US-EMLP (15X5) SR CUS - Plastic label

0830078

<https://www.phoenixcontact.com/in/products/0830078>

Plastic label, can be ordered: by card, silver, labeled according to customer specifications, mounting type: adhesive, lettering field size: 15 x 5 mm, Number of individual labels: 189



# MINI MCR-2-UNI-UI-2UI - Signal duplicator



2905026

<https://www.phoenixcontact.com/in/products/2905026>

## UCT-EM (30X5) YE - Marker for end clamp

0830340

<https://www.phoenixcontact.com/in/products/0830340>



Marker for end clamp, Sheet, yellow, unlabeled, can be labeled with: TOPMARK NEO, TOPMARK LASER, BLUEMARK ID COLOR, BLUEMARK ID, BLUEMARK CLED, THERMOMARK PRIME, THERMOMARK CARD 2.0, THERMOMARK CARD, mounting type: snapped, lettering field size: 30 x 5 mm, Number of individual labels: 24

---

## UCT-EM (30X5) YE CUS - Marker for end clamp

0830348

<https://www.phoenixcontact.com/in/products/0830348>



Marker for end clamp, can be ordered: by sheet, yellow, labeled according to customer specifications, mounting type: snapped into marker carrier, lettering field size: 30 x 5 mm, Number of individual labels: 24

---

Phoenix Contact 2023 © - all rights reserved

<https://www.phoenixcontact.com>

PHOENIX CONTACT (I) Pvt. Ltd.

A-58/2, Okhla Industrial Area, Phase - II, New Delhi-110 020

+91.1275.71420

[info@phoenixcontact.co.in](mailto:info@phoenixcontact.co.in)