

# Product datasheet

Specifications



## controller M200 16 IO transistor SINK

TM200C16U

### Main

Range of product	Easy Modicon M200
Product or component type	Logic controller
[Us] rated supply voltage	24 V DC
Discrete I/O number	16
Discrete input number	I8: 1 regular input I2...I5: 4 fast input I0, I1, I6, I7: 4 high speed input
Discrete output number	Q2...Q6: 5 transistor output Q0...Q1: 2 fast output (PLS/PWM/PTO mode)
Discrete input voltage	24 V
Discrete input voltage type	DC
Discrete input current	7 mA for input
Discrete input logic	Sink or source (positive/negative) type 1 conforming to EN/IEC 61131-2
Discrete output voltage	24 V DC
Discrete output current	0.5 A
Discrete output type	Transistor
Discrete output logic	Negative logic (sink)
Power consumption in W	10 W at 24 V DC (with max I/O)

### Complementary

Maximum number of I/O expansion module	4 with 135 discrete output(s) for transistor output 4 with 64 discrete output(s) for relay output
Supply voltage limits	20.4...28.8 V
Inrush current	35 A
Voltage state 1 guaranteed	$\geq 15$ V for input
Voltage state 0 guaranteed	$\leq 5$ V for input
Input impedance	3.3 kOhm for discrete input
Response time	1 ms turn-on, Q0...Q6 terminal(s) for output 1 ms turn-off, Q0...Q6 terminal(s) for output 5 $\mu$ s turn-off, I0, I1, I6, I7 terminal(s) for high speed input 5 $\mu$ s turn-on, I0, I1, I6, I7 terminal(s) for high speed input 100 $\mu$ s turn-off, I2...I5 terminal(s) for fast input 35 $\mu$ s turn-on, I2...I5 terminal(s) for fast input 100 $\mu$ s turn-off, I8 terminal(s) for regular input 35 $\mu$ s turn-on, I8 terminal(s) for regular input

<b>Configurable filtering time</b>	0 ms for input 3 ms for input 12 ms for input
<b>Maximum current per output common</b>	3.5 A at COM 0
<b>Output frequency</b>	100 kHz for fast output (PWM/PLS mode) at Q0...Q1
<b>Maximum leakage current</b>	0.1 mA for transistor output
<b>Maximum voltage drop</b>	<1 V
<b>Maximum tungsten load</b>	<12 W for output and fast output
<b>Protection type</b>	Overload and short-circuit protection at 3.8 A
<b>Reset time</b>	1 s automatic reset
<b>Memory capacity</b>	512 byte internal flash for backup of programs
<b>Data storage equipment</b>	32 GB micro SD card (optional)
<b>Battery type</b>	BR2032 Li-CFx (Lithium-Carbon Monofluoride), battery life: 5 year(s)
<b>Backup time</b>	3 years at 25 °C (by interruption of power supply)
<b>Execution time for 1 KInstruction</b>	0.3 ms for event and periodic task
<b>Execution time per instruction</b>	0.2 µs Boolean
<b>Exct time for event task</b>	60 µs response time
<b>Clock drift</b>	<= 90 s/month at 25 °C
<b>Regulation loop</b>	Adjustable PID regulator up to 14 simultaneous loops
<b>Positioning functions</b>	PWM/PLS 2 channel(s) at 100 kHz
<b>Control signal type</b>	Quadrature (x1, x2, x4) at 100 kHz for fast input (HSC mode) Pulse/direction at 100 kHz for fast input (HSC mode) Single phase at 100 kHz for fast input (HSC mode) CW/CCW at 100 kHz for fast input (HSC mode)
<b>Counting input number</b>	4 fast input (HSC mode) at 100 kHz 32 bits
<b>Integrated connection type</b>	USB port with mini B USB 2.0 connector Non isolated serial link serial 1 with terminal block connector and RS485 interface Non isolated serial link serial 2 with terminal block connector and RS232/RS485 interface Isolated serial link serial 2 with terminal block connector and RS485 interface
<b>Transmission rate</b>	1.2...115.2 kbit/s (115.2 kbit/s by default) for bus length of 15 m for RS485 1.2...115.2 kbit/s (115.2 kbit/s by default) for bus length of 3 m for RS232 12 Mbit/s for USB
<b>Communication port protocol</b>	USB port: USB - SoMachine-Network Non isolated serial link: Modbus master/slave - RTU/ASCII or SoMachine-Network
<b>Local signalling</b>	1 LED (green) for PWR 1 LED (green) for RUN 1 LED (red) for module error (ERR) 1 LED (green) for SD card access (SD) 1 LED (red) for BAT 1 LED (green) for SL1 1 LED per channel (green) for I/O state
<b>Electrical connection</b>	Mini B USB 2.0 connector for a programming terminal removable screw terminal block for inputs removable screw terminal block for outputs removable screw terminal block, 3 terminal(s) for connecting the 24 V DC power supply removable screw terminal block, 4 terminal(s) for connecting the serial link 1
<b>Maximum cable distance between devices</b>	Unshielded cable: <50 m for input Shielded cable: <10 m for fast input Shielded cable: <10 m for high speed input Unshielded cable: <150 m for output
<b>Insulation</b>	Non-insulated between inputs Between input and internal logic at 500 V AC Between fast input and internal logic at 500 V AC Between input groups at 500 V AC Between output and internal logic at 500 V AC Between output groups at 500 V AC Between supply and internal logic at 500 V DC
<b>Marking</b>	CE

<b>Mounting support</b>	Top hat type TH35-15 rail conforming to IEC 60715 Top hat type TH35-7.5 plate or panel with fixing kit conforming to IEC 60715
<b>Height</b>	90 mm
<b>Depth</b>	70 mm
<b>Width</b>	110 mm
<b>Net weight</b>	0.339 kg

## Environment

<b>IP degree of protection</b>	IP20 with protective cover in place
<b>Product certifications</b>	CSA IACS E10 RCM cULus
<b>Standards</b>	EN/IEC 61010-2-201 EN/IEC 61131-2

<b>Electromagnetic compatibility</b>	Electrostatic discharge immunity test - test level: 8 kV (air discharge) conforming to EN/IEC 61000-4-2 Electrostatic discharge immunity test - test level: 6 kV (contact discharge) conforming to EN/IEC 61000-4-2 Susceptibility to electromagnetic fields - test level: 10 V/m (80 MHz...3 GHz) conforming to EN/IEC 61000-4-3 Magnetic field at power frequency - test level: 30 A/m conforming to EN/IEC 61000-4-8 Electrical fast transient/burst immunity test - test level: 2 kV (power lines) conforming to EN/IEC 61000-4-4 Electrical fast transient/burst immunity test - test level: 2 kV (relay output) conforming to EN/IEC 61000-4-4 Electrical fast transient/burst immunity test - test level: 1 kV (I/O) conforming to EN/IEC 61000-4-4 Electrical fast transient/burst immunity test - test level: 1 kV (serial link) conforming to EN/IEC 61000-4-4 1.2/50 µs shock waves immunity test - test level: 1 kV (power lines (DC)) conforming to EN/IEC 61000-4-5 1.2/50 µs shock waves immunity test - test level: 2 kV (power lines (AC)) conforming to EN/IEC 61000-4-5 1.2/50 µs shock waves immunity test - test level: 2 kV (relay output) conforming to EN/IEC 61000-4-5 1.2/50 µs shock waves immunity test - test level: 1 kV (I/O) conforming to EN/IEC 61000-4-5 1.2/50 µs shock waves immunity test - test level: 1 kV (shielded cable) conforming to EN/IEC 61000-4-5 1.2/50 µs shock waves immunity test - test level: 0.5 kV (power lines (DC)) conforming to EN/IEC 61000-4-5 1.2/50 µs shock waves immunity test - test level: 1 kV (power lines (AC)) conforming to EN/IEC 61000-4-5 Conducted RF disturbances - test level: 10 V (0.15...80 MHz) conforming to EN/IEC 61000-4-6 Conducted emission - test level: 79 dBµV/m QP/66 dBµV/m AV (power lines (AC)) conforming to EN/IEC 55011 Conducted emission - test level: 73 dBµV/m QP/60 dBµV/m AV (power lines (AC)) conforming to EN/IEC 55011 Radiated emission - test level: 40 dBµV/m QP class A (10 m) conforming to EN/IEC 55011 Radiated emission - test level: 47 dBµV/m QP class A (10 m) conforming to EN/IEC 55011
--------------------------------------	---

<b>Shock resistance</b>	15 gn for 11 ms 30 gn for 6 ms
-------------------------	-----------------------------------

<b>Immunity to microbreaks</b>	2 ms
--------------------------------	------

<b>Vibration resistance</b>	3.5 mm at 5...8.4 Hz on symmetrical rail 1 gn at 8.4...150 Hz on symmetrical rail 3.5 mm at 5...8.7 Hz on panel mounting 2 gn at 8.7...150 Hz on panel mounting
-----------------------------	--

<b>Relative humidity</b>	10...95 %, without condensation (in operation) 10...95 %, without condensation (in storage)
--------------------------	--

<b>Ambient air temperature for operation</b>	0...55 °C (horizontal installation)
--	-------------------------------------

<b>Ambient air temperature for storage</b>	-25...70 °C
--	-------------

<b>Pollution degree</b>	<= 2
-------------------------	------

<b>Operating altitude</b>	0...2000 m
---------------------------	------------

<b>Storage altitude</b>	0...3000 m
-------------------------	------------

## Packing Units

<b>Unit Type of Package 1</b>	PCE
-------------------------------	-----

<b>Number of Units in Package 1</b>	1
-------------------------------------	---

<b>Package 1 Height</b>	13.6 cm
-------------------------	---------

Package 1 Width	9 cm
Package 1 Length	11.8 cm
Package 1 Weight	512.5 g
Unit Type of Package 2	S03
Number of Units in Package 2	18
Package 2 Height	30 cm
Package 2 Width	30 cm
Package 2 Length	40 cm
Package 2 Weight	9756 g
Unit Type of Package 3	P12
Number of Units in Package 3	288
Package 3 Height	80 cm
Package 3 Width	120 cm
Package 3 Length	110 cm
Package 3 Weight	243144 g

## Offer Sustainability

Sustainable offer status	Green Premium product
REACH Regulation	<a href="#">REACH Declaration</a>
EU RoHS Directive	Pro-active compliance (Product out of EU RoHS legal scope) <a href="#">EU RoHS Declaration</a>
Mercury free	Yes
China RoHS Regulation	<a href="#">China RoHS declaration</a>
RoHS exemption information	<a href="#">Yes</a>
Environmental Disclosure	<a href="#">Product Environmental Profile</a>
Circularity Profile	<a href="#">End of Life Information</a>
WEEE	The product must be disposed on European Union markets following specific waste collection and never end up in rubbish bins

Dimensions Drawings

Dimensions

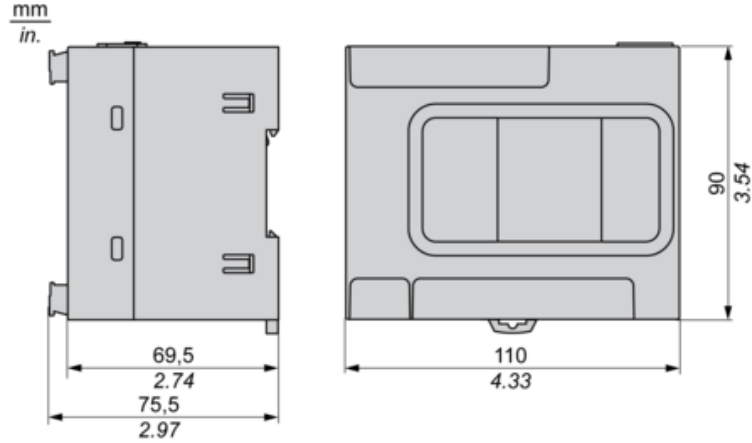

**Mounting and Clearance**

---

**Mounting on a Rail**

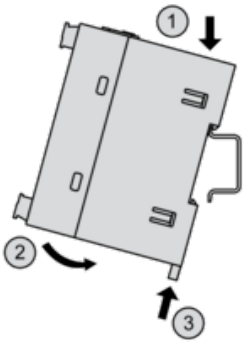

**Direct Mounting on a Panel Surface**

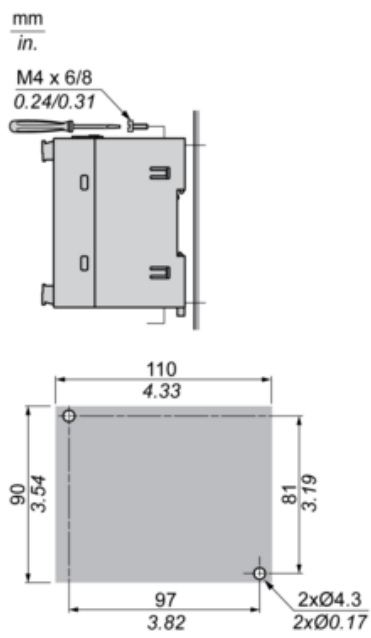

**Mounting Position**

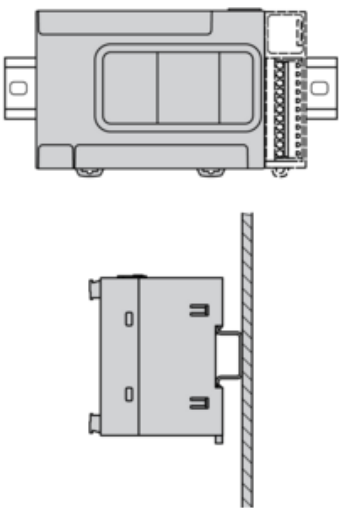

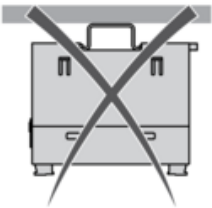
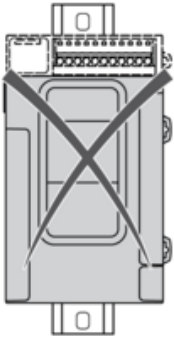
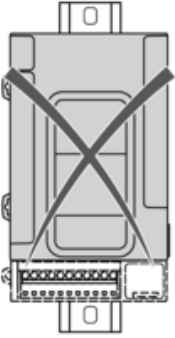
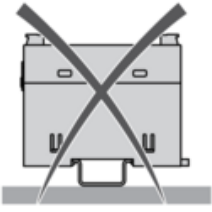

### Clearance

mm  
in.

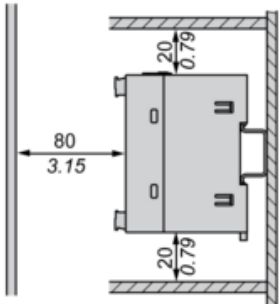
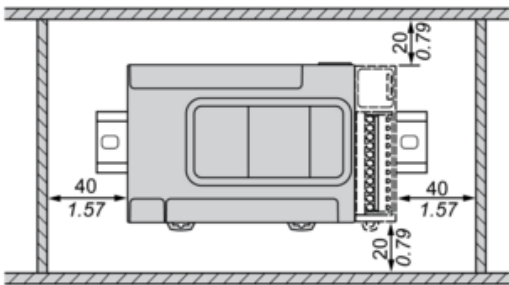

## TMCR2...Installation

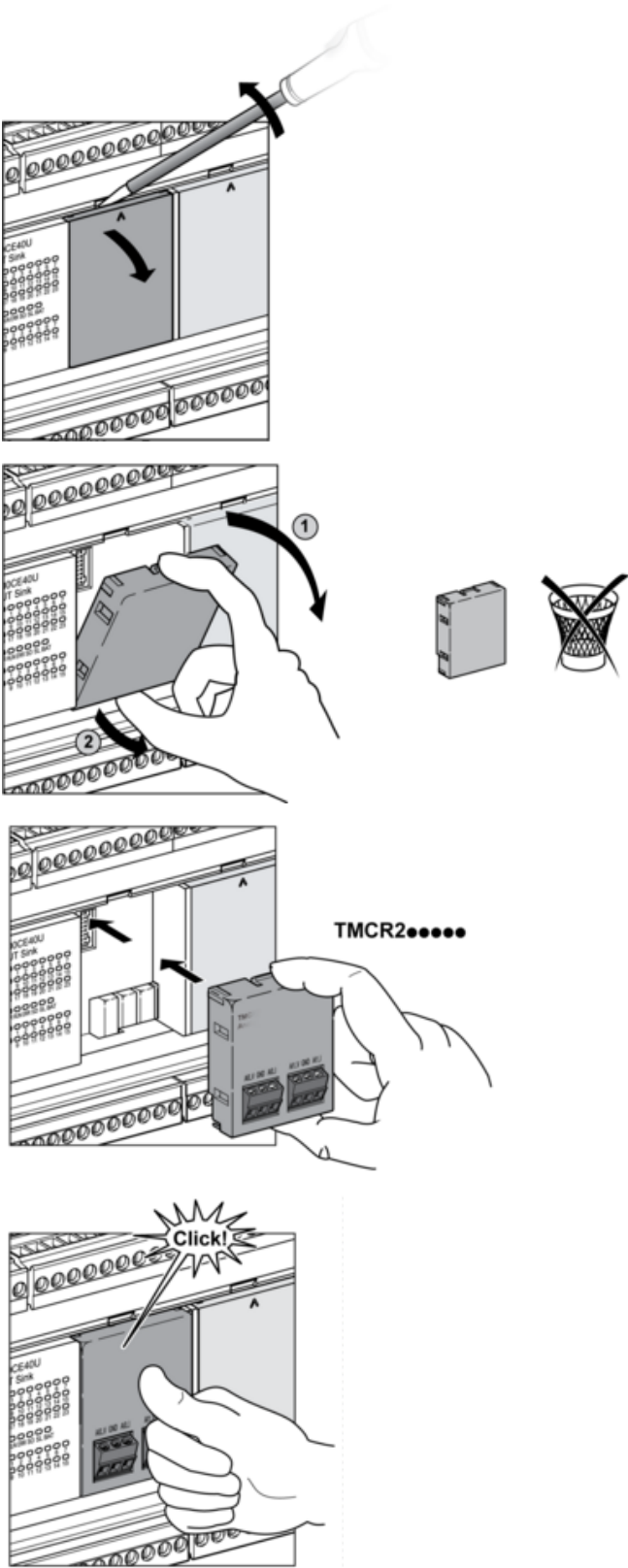

## TMCR2... De-Installation

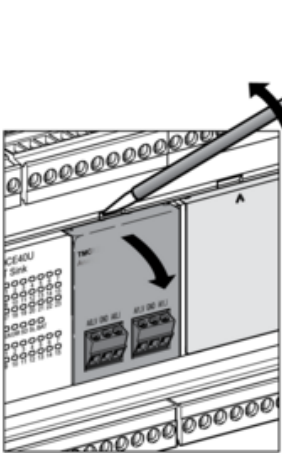



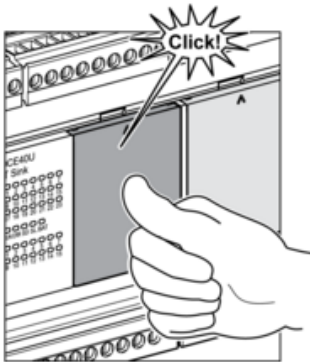
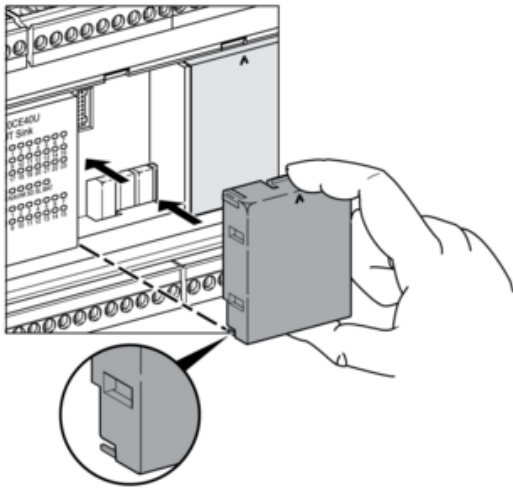
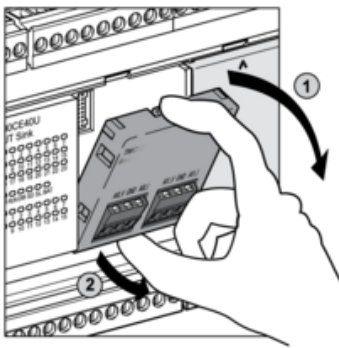

**Wiring Diagram / Connections Schema**

**DC Power Supply**

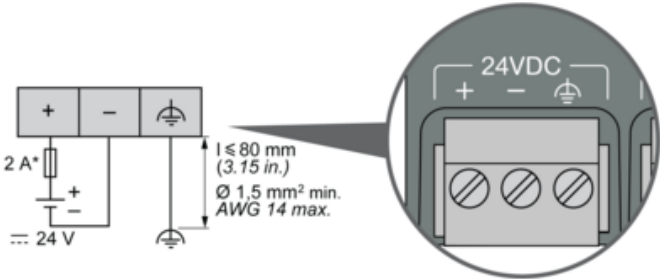
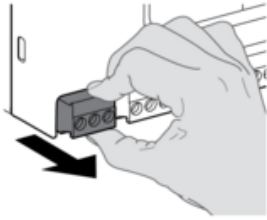

(\*) Type T fuse

**Digital Inputs (Sink or Source)**

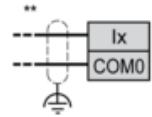
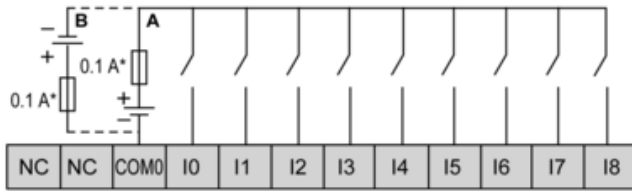

(\*) Type T fuse

A : Sink wiring (positive logic)

B : Source wiring (negative logic)

(\*\*) Fast inputs

**Regular and Fast Transistor Output**

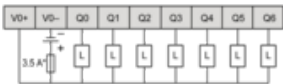

(\*) Type T fuse

(\*\*) Fast inputs

(1) The V0+ and V1+ terminals are not connected internally.

(2) The V0- and V1- terminals are not connected internally.

**USB Mini-B Connection**

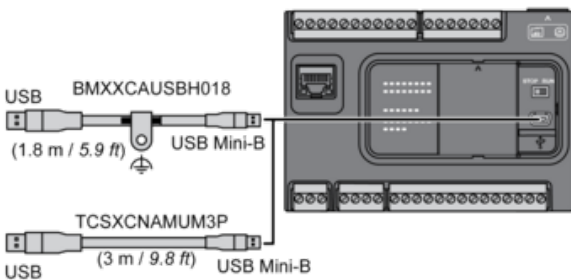

## SL1 Connection

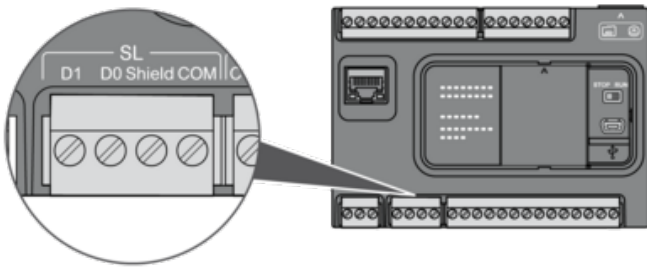

**D1** : D1 (A+)

**D0** : D0 (B-)

**Shield** : Shield

**COM** : O V Com

**Derating Curves**

---

**Digital Inputs**

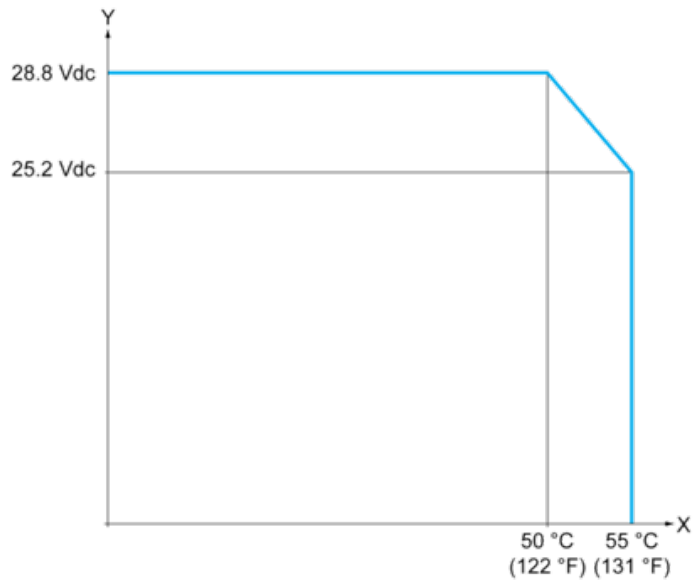

X : Ambient temperature (°C / °F)

Y : Input voltage (V)

**Recommended replacement(s)**