

SP 4/ 1-M - Plug

3042780

<https://www.phoenixcontact.com/in/products/3042780>



Please be informed that the data shown in this PDF document is generated from our Online Catalog. Please find the complete data in the user documentation. Our General Terms of Use for Downloads are valid.



Plug, nom. voltage: 800 V, nominal current: 32 A, number of positions: 1, connection method: Spring-cage connection, Rated cross section: 4 mm², cross section: 0.08 mm²- 6 mm², color: gray

Product Description

Connector element center, left housing with engagement pin, right opened without cover

Your advantages

- Cable housing can be snapped on to the plugs, see figure below
- The plug with spring-cage connection is assembled directly on site by snapping together single-position plug elements
- The ST-COMBI plugs for self-assembly provide solutions that users can implement themselves
- Tested for railway applications

Commercial Data

Item number	3042780
Packing unit	50 pc
Minimum order quantity	50 pc
Sales Key	BE2
Product Key	BE2144
Catalog Page	Page 345 (C-1-2019)
GTIN	4017918956080
Weight per Piece (including packing)	4.5 g
Weight per Piece (excluding packing)	3.9 g
Customs tariff number	85366990
Country of origin	PL

SP 4/ 1-M - Plug

3042780

<https://www.phoenixcontact.com/in/products/3042780>



Technical Data

Product properties

Product type	Terminal plug
Number of positions	1
Pitch	6.2 mm

Insulation characteristics

Overvoltage category	III
Degree of pollution	3

Electrical properties

Rated surge voltage	8 kV
---------------------	------

Connection data

Nominal cross section	4 mm ²
Stripping length	8 mm ... 10 mm
Internal cylindrical gage	A4
Connection in acc. with standard	IEC 61984
Conductor cross section rigid	0.08 mm ² ... 6 mm ²
Cross section AWG	28 ... 10 (converted acc. to IEC)
Conductor cross section flexible	0.08 mm ² ... 4 mm ²
Conductor cross section, flexible [AWG]	28 ... 10 (converted acc. to IEC)
Conductor cross-section flexible (ferrule without plastic sleeve)	0.14 mm ² ... 4 mm ²
Flexible conductor cross section (ferrule with plastic sleeve)	0.14 mm ² ... 4 mm ²
2 conductors with the same cross section, flexible, with TWIN ferrule with plastic sleeve	0.5 mm ² ... 1 mm ²
Nominal current	32 A
Maximum load current	32 A (with 6 mm ² conductor cross section)
Nominal voltage	800 V
Nominal cross section	4 mm ²

Dimensions

Width	6.2 mm
Height	41.5 mm
Length	21 mm
Pitch	6.2 mm

Material specifications

Color	gray
Flammability rating according to UL 94	V0
Insulating material group	I
Insulating material	PA
Static insulating material application in cold	-60 °C

SP 4/ 1-M - Plug



3042780

<https://www.phoenixcontact.com/in/products/3042780>

Temperature index of insulation material (DIN EN 60216-1 (VDE 0304-21))	130 °C
Relative insulation material temperature index (Elec., UL 746 B)	130 °C
Fire protection for rail vehicles (DIN EN 45545-2) R22	HL 1 - HL 3
Fire protection for rail vehicles (DIN EN 45545-2) R23	HL 1 - HL 3
Fire protection for rail vehicles (DIN EN 45545-2) R24	HL 1 - HL 3
Fire protection for rail vehicles (DIN EN 45545-2) R26	HL 1 - HL 3
Calorimetric heat release NFPA 130 (ASTM E 1354)	28 MJ/kg
Surface flammability NFPA 130 (ASTM E 162)	passed
Specific optical density of smoke NFPA 130 (ASTM E 662)	passed
Smoke gas toxicity NFPA 130 (SMP 800C)	passed

Environmental and real-life conditions

Ambient conditions

Ambient temperature (operation)	-60 °C ... 105 °C (max. short-term operating temperature RTI Elec.)
Ambient temperature (storage/transport)	-25 °C ... 60 °C (for a short time, not exceeding 24 h, -60 °C to +70 °C)
Ambient temperature (assembly)	-5 °C ... 70 °C
Ambient temperature (actuation)	-5 °C ... 70 °C
Permissible humidity (storage/transport)	30 % ... 70 %

Standards and regulations

Connection in acc. with standard	IEC 61984
----------------------------------	-----------

SP 4/ 1-M - Plug

3042780

<https://www.phoenixcontact.com/in/products/3042780>

Drawings

Schematic diagram

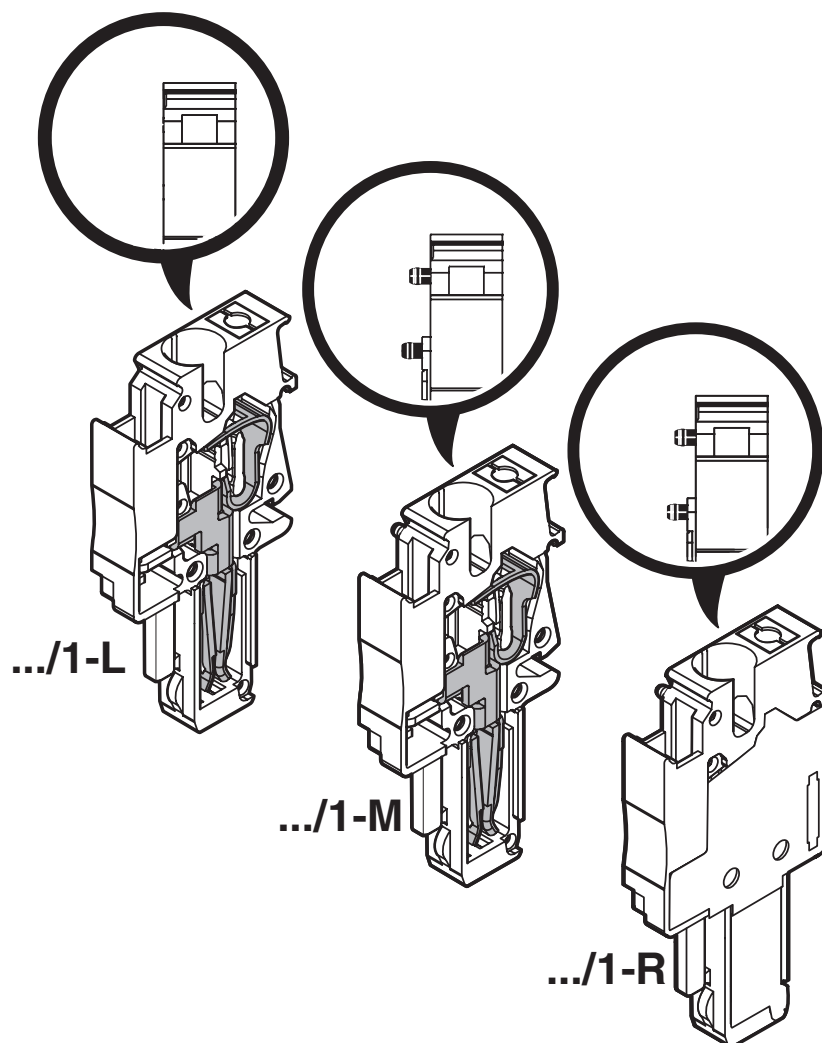

Circuit diagram



Diagram

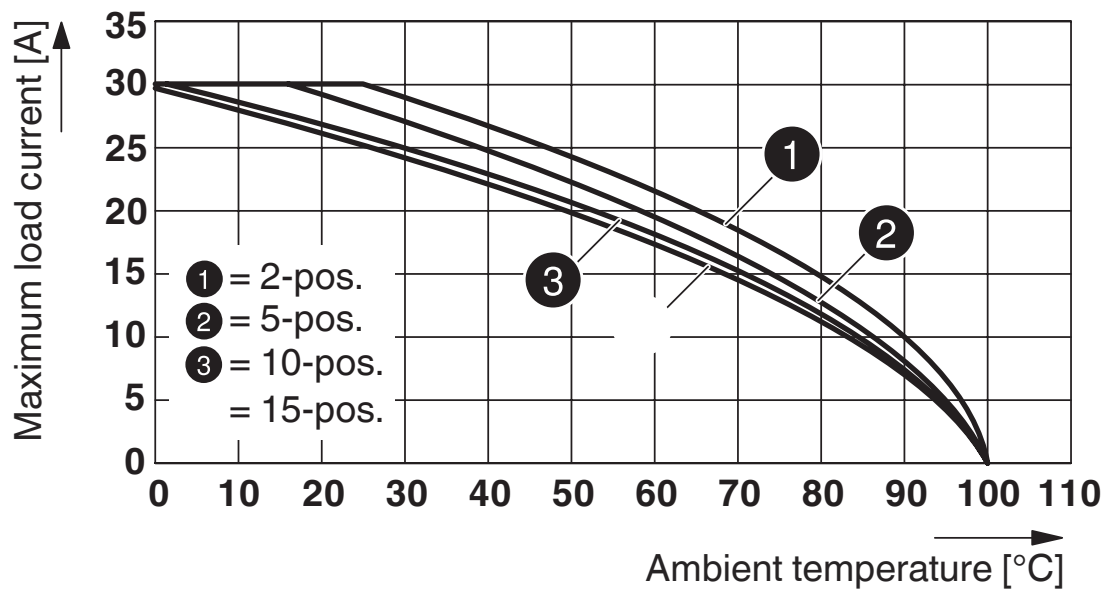

Derating curve for ST 4/ 1P and for all plug versions SP...

Diagram

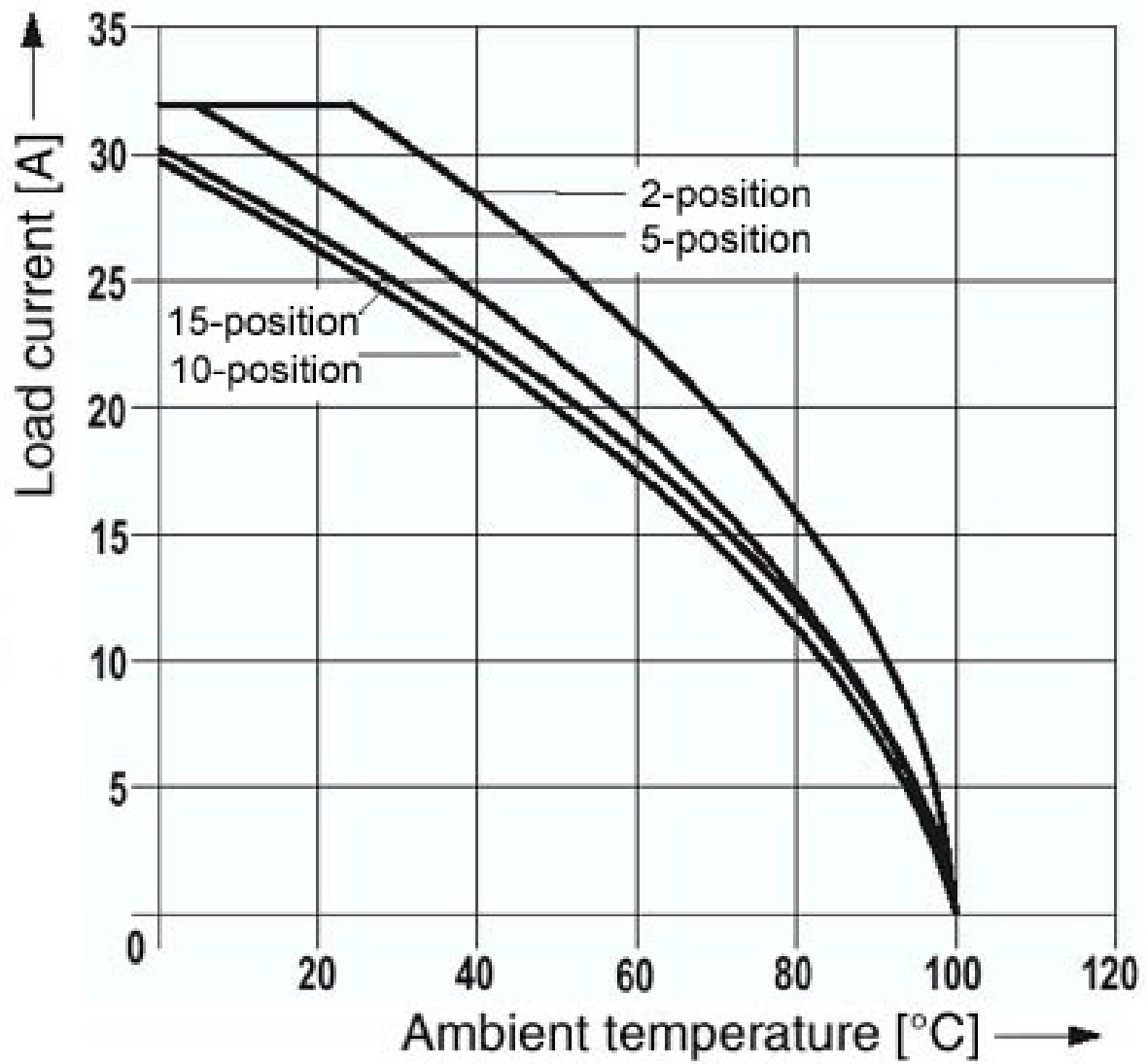

Derating curve for the spring-cage terminal with all plug versions SP 4/... .

SP 4/ 1-M - Plug

3042780

<https://www.phoenixcontact.com/in/products/3042780>

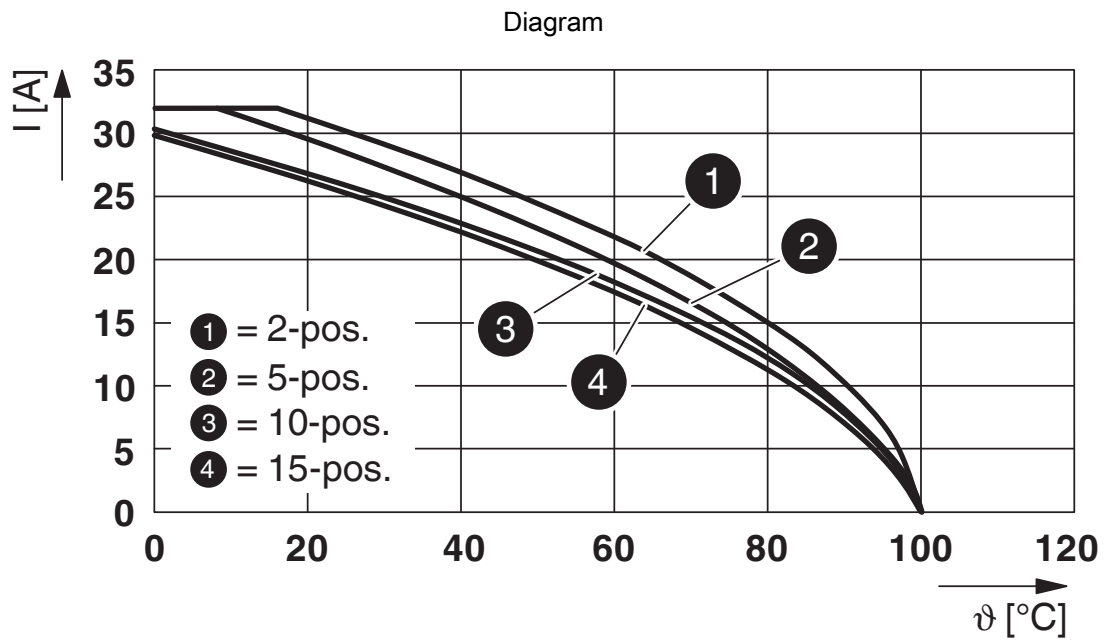

Derating curve for spring-cage terminals ST 4/1P.. and ST 4/2P.. with all plug versions SP 4/... . The derating curves are determined by multiplying the values of the base curves by the factor 0.8.

SP 4/ 1-M - Plug





3042780

<https://www.phoenixcontact.com/in/products/3042780>

Approvals

 CSA Approval ID: 13631				
	Nominal Voltage U_N	Nominal Current I_N	Cross Section AWG	Cross Section mm^2
Use group B	600 V	30 A	24 - 12	-
Use group C	600 V	30 A	24 - 12	-

 IECEE CB Scheme Approval ID: DE1-62736/B1/B2				
--	--	--	--	--

 EAC Approval ID: RU C-DE.BL08.B.00511				
---	--	--	--	--

 cULus Recognized Approval ID: E60425				
	Nominal Voltage U_N	Nominal Current I_N	Cross Section AWG	Cross Section mm^2
Use group B	600 V	30 A	28 - 10	-
Use group C	600 V	30 A	28 - 10	-

 VDE Zeichengenehmigung Approval ID: 40019518				
	Nominal Voltage U_N	Nominal Current I_N	Cross Section AWG	Cross Section mm^2
Only flexible conductors	800 V	-	-	0.2 - 4
Only rigid conductors	800 V	-	-	0.2 - 6

SP 4/ 1-M - Plug

3042780

<https://www.phoenixcontact.com/in/products/3042780>



Classifications

ECLASS

ECLASS-11.0	27141151
ECLASS-12.0	27141151
ECLASS-13.0	27250306

ETIM

ETIM 8.0	EC002021
----------	----------

UNSPSC

UNSPSC 21.0	39121400
-------------	----------

SP 4/ 1-M - Plug

3042780

<https://www.phoenixcontact.com/in/products/3042780>



Environmental Product Compliance

China RoHS	Environmentally friendly use period: unlimited = EFUP-e
	No hazardous substances above threshold values

SP 4/ 1-M - Plug

3042780

<https://www.phoenixcontact.com/in/products/3042780>



Accessories

PZ/2 - Strain relief

3040627

<https://www.phoenixcontact.com/in/products/3040627>



Strain relief, length: 48.7 mm, width: 9.3 mm, number of positions: 2, color: black

PZ/4 - Strain relief

3040643

<https://www.phoenixcontact.com/in/products/3040643>



Strain relief, length: 48.7 mm, width: 19.6 mm, number of positions: 4, color: black

SP 4/ 1-M - Plug

3042780

<https://www.phoenixcontact.com/in/products/3042780>

PR - Latching

3040559

<https://www.phoenixcontact.com/in/products/3040559>



Latching, length: 29.8 mm, width: 4.4 mm, number of positions: 1, color: orange

PR/2 - Latching

3040630

<https://www.phoenixcontact.com/in/products/3040630>



Latching, length: 29.8 mm, width: 10 mm, number of positions: 2, color: orange

SP 4/ 1-M - Plug

3042780

<https://www.phoenixcontact.com/in/products/3042780>

PRT/2 - Latching

3040631

<https://www.phoenixcontact.com/in/products/3040631>



Latching, can only be released using a screwdriver, length: 23.2 mm, width: 9 mm, number of positions: 2, color: orange

PRZ - Latching

3040614

<https://www.phoenixcontact.com/in/products/3040614>



Latching, number of positions: 2, length: 64 mm, color: orange

SP 4/ 1-M - Plug

3042780

<https://www.phoenixcontact.com/in/products/3042780>



PSH 3- 6 - Shield connection clamp

3040591

<https://www.phoenixcontact.com/in/products/3040591>



Shield connection clamp, color: black

PSH 5-10 - Shield connection clamp

3040601

<https://www.phoenixcontact.com/in/products/3040601>



Shield connection clamp, color: black

SP 4/ 1-M - Plug

3042780

<https://www.phoenixcontact.com/in/products/3042780>



B-STIFT - Marker pen

1051993

<https://www.phoenixcontact.com/in/products/1051993>



Marker pen, for manual labeling of unprinted Zack strips, smear-proof and waterproof, line thickness 0.5 mm

X-PEN 0,35 - Marker pen

0811228

<https://www.phoenixcontact.com/in/products/0811228>



Marker pen without ink cartridge, for manual labeling of markers, labeling extremely wipe-proof, line thickness 0.35 mm

SP 4/ 1-M - Plug

3042780

<https://www.phoenixcontact.com/in/products/3042780>



ST-BW - Actuation tool

1207608

<https://www.phoenixcontact.com/in/products/1207608>

Actuation tool, for all 2.5 mm² - 4.0 mm² spring-cages



ZBF 6:UNBEDRUCKT - Zack Marker strip, flat

0808710

<https://www.phoenixcontact.com/in/products/0808710>



Zack Marker strip, flat, Strip, white, unlabeled, can be labeled with: PLOTMARK, CMS-P1-PLOTTER, mounting type: snapped, for terminal block width: 6.2 mm, lettering field size: 5.15 x 6.15 mm, Number of individual labels: 10

SP 4/ 1-M - Plug

3042780

<https://www.phoenixcontact.com/in/products/3042780>



ZBF 6 CUS - Zack Marker strip, flat

0825027

<https://www.phoenixcontact.com/in/products/0825027>



Zack Marker strip, flat, Strip, can be ordered: Strip, white, labeled according to customer specifications, mounting type: snap into flat marker groove, for terminal block width: 6.2 mm, lettering field size: 5.15 x 6.15 mm, Number of individual labels: 10

UC-TMF 6 - Marker for terminal blocks

0818140

<https://www.phoenixcontact.com/in/products/0818140>



Marker for terminal blocks, Sheet, white, unlabeled, can be labeled with: BLUEMARK ID COLOR, BLUEMARK ID, BLUEMARK CLED, PLOTMARK, CMS-P1-PLOTTER, mounting type: snapped, for terminal block width: 6.2 mm, lettering field size: 5.6 x 5.1 mm, Number of individual labels: 80

SP 4/ 1-M - Plug

3042780

<https://www.phoenixcontact.com/in/products/3042780>



UC-TMF 6 CUS - Marker for terminal blocks

0824646

<https://www.phoenixcontact.com/in/products/0824646>



Marker for terminal blocks, can be ordered: by sheet, white, labeled according to customer specifications, mounting type: snap into flat marker groove, for terminal block width: 6.2 mm, lettering field size: 5.6 x 5.1 mm, Number of individual labels: 80

UCT-TMF 6 - Marker for terminal blocks

0828746

<https://www.phoenixcontact.com/in/products/0828746>



Marker for terminal blocks, Sheet, white, unlabeled, can be labeled with: TOPMARK NEO, TOPMARK LASER, BLUEMARK ID COLOR, BLUEMARK ID, BLUEMARK CLED, THERMOMARK PRIME, THERMOMARK CARD 2.0, THERMOMARK CARD, mounting type: snapped, for terminal block width: 6.2 mm, lettering field size: 5.4 x 4.7 mm, Number of individual labels: 60

SP 4/ 1-M - Plug

3042780

<https://www.phoenixcontact.com/in/products/3042780>



UCT-TMF 6 CUS - Marker for terminal blocks

0829665

<https://www.phoenixcontact.com/in/products/0829665>



Marker for terminal blocks, can be ordered: by sheet, white, labeled according to customer specifications, mounting type: snap into flat marker groove, for terminal block width: 6.2 mm, lettering field size: 5.4 x 4.7 mm, Number of individual labels: 60

ZBF 6,LGS:FORTL.ZAHLEN - Zack Marker strip, flat

0808749

<https://www.phoenixcontact.com/in/products/0808749>



Zack Marker strip, flat, Strip, white, labeled, printed horizontally: consecutive numbers 1 ... 10, 11 ... 20, etc. up to 91 ... 100, mounting type: snapped, for terminal block width: 6.2 mm, lettering field size: 5.15 x 6.15 mm, Number of individual labels: 10

SP 4/ 1-M - Plug

3042780

<https://www.phoenixcontact.com/in/products/3042780>



ZBF 6,QR:FORTL.ZAHLEN - Zack Marker strip, flat

0808765

<https://www.phoenixcontact.com/in/products/0808765>



Zack Marker strip, flat, Strip, white, labeled, Printed vertically: consecutive numbers 1 ... 10, 11 ... 20, etc. up to 91 ... 100, mounting type: snapped, for terminal block width: 6.2 mm, lettering field size: 5.15 x 6.15 mm, Number of individual labels: 10

ZBF 6,LGS:GERADE ZAHLEN - Zack Marker strip, flat

0810834

<https://www.phoenixcontact.com/in/products/0810834>



Zack Marker strip, flat, Strip, white, labeled, printed horizontally: consecutive even numbers 2 ... 20, 22 ... 40, etc. up to 82 ... 100, mounting type: snapped, for terminal block width: 6.2 mm, lettering field size: 5.15 x 6.15 mm, Number of individual labels: 10

SP 4/ 1-M - Plug

3042780

<https://www.phoenixcontact.com/in/products/3042780>



ZBF 6,LGS:UNGERADE ZAHLEN - Zack Marker strip, flat

0810876

<https://www.phoenixcontact.com/in/products/0810876>



Zack Marker strip, flat, Strip, white, labeled, printed horizontally: Odd numbers 1 - 19, 21 - 39, etc. up to 81 - 99, mounting type: snapped, for terminal block width: 6.2 mm, lettering field size: 5.15 x 6.15 mm, Number of individual labels: 10

Phoenix Contact 2023 © - all rights reserved

<https://www.phoenixcontact.com>

PHOENIX CONTACT (I) Pvt. Ltd.

A-58/2, Okhla Industrial Area, Phase - II, New Delhi-110 020

+91.1275.71420

info@phoenixcontact.co.in