

SPDB 2,5/ 1-L - Plug

3043190

<https://www.phoenixcontact.com/in/products/3043190>



Please be informed that the data shown in this PDF document is generated from our Online Catalog. Please find the complete data in the user documentation. Our General Terms of Use for Downloads are valid.



Plug, nom. voltage: 500 V, nominal current: 24 A, number of positions: 1, connection method: Spring-cage connection, Rated cross section: 2.5 mm², cross section: 0.08 mm²- 4 mm², color: gray

Product Description

Connector element left, left housing without engagement pin, right opened without cover

Your advantages

- Plug with bridging option, for use with basic terminal blocks
- The plug with spring-cage connection is assembled directly on site by snapping together single-position plug elements
- The ST-COMBI plugs for self-assembly provide solutions that users can implement themselves
- Tested for railway applications

Commercial Data

| | |
|--------------------------------------|---------------------|
| Item number | 3043190 |
| Packing unit | 50 pc |
| Minimum order quantity | 50 pc |
| Sales Key | BE2 |
| Product Key | BE2144 |
| Catalog Page | Page 322 (C-1-2019) |
| GTIN | 4017918895051 |
| Weight per Piece (including packing) | 4.907 g |
| Weight per Piece (excluding packing) | 4.907 g |
| Customs tariff number | 85366990 |
| Country of origin | PL |

SPDB 2,5/ 1-L - Plug

3043190

<https://www.phoenixcontact.com/in/products/3043190>

Technical Data

Product properties

| | |
|---------------------|---------------|
| Product type | Terminal plug |
| Number of positions | 1 |
| Pitch | 5.2 mm |

Insulation characteristics

| | |
|----------------------|-----|
| Overvoltage category | III |
| Degree of pollution | 3 |

Electrical properties

| | |
|---------------------|------|
| Rated surge voltage | 6 kV |
|---------------------|------|

Connection data

| | |
|---|---|
| Nominal cross section | 2.5 mm ² |
| Stripping length | 8 mm ... 10 mm |
| Internal cylindrical gage | A3 |
| Connection in acc. with standard | IEC 61984 |
| Conductor cross section rigid | 0.08 mm ² ... 4 mm ² |
| Cross section AWG | 28 ... 12 (converted acc. to IEC) |
| Conductor cross section flexible | 0.08 mm ² ... 2.5 mm ² |
| Conductor cross section, flexible [AWG] | 28 ... 14 (converted acc. to IEC) |
| Conductor cross-section flexible (ferrule without plastic sleeve) | 0.14 mm ² ... 2.5 mm ² |
| Flexible conductor cross section (ferrule with plastic sleeve) | 0.14 mm ² ... 2.5 mm ² |
| 2 conductors with the same cross section, flexible, with TWIN ferrule with plastic sleeve | 0.5 mm ² |
| Nominal current | 24 A |
| Maximum load current | 24 A (with 4 mm ² conductor cross section) |
| Nominal voltage | 500 V |
| Nominal cross section | 2.5 mm ² |

Dimensions

| | |
|--------|---------|
| Width | 5.2 mm |
| Height | 39 mm |
| Length | 32.7 mm |
| Pitch | 5.2 mm |

Material specifications

| | |
|--|--------|
| Color | gray |
| Flammability rating according to UL 94 | V0 |
| Insulating material group | I |
| Insulating material | PA |
| Static insulating material application in cold | -60 °C |

SPDB 2,5/ 1-L - Plug



3043190

<https://www.phoenixcontact.com/in/products/3043190>

| | |
|---|-------------|
| Temperature index of insulation material (DIN EN 60216-1 (VDE 0304-21)) | 130 °C |
| Relative insulation material temperature index (Elec., UL 746 B) | 130 °C |
| Fire protection for rail vehicles (DIN EN 45545-2) R22 | HL 1 - HL 3 |
| Fire protection for rail vehicles (DIN EN 45545-2) R23 | HL 1 - HL 3 |
| Fire protection for rail vehicles (DIN EN 45545-2) R24 | HL 1 - HL 3 |
| Fire protection for rail vehicles (DIN EN 45545-2) R26 | HL 1 - HL 3 |
| Calorimetric heat release NFPA 130 (ASTM E 1354) | 28 MJ/kg |
| Surface flammability NFPA 130 (ASTM E 162) | passed |
| Specific optical density of smoke NFPA 130 (ASTM E 662) | passed |
| Smoke gas toxicity NFPA 130 (SMP 800C) | passed |

Environmental and real-life conditions

Ambient conditions

| | |
|--|---|
| Ambient temperature (operation) | -60 °C ... 105 °C (max. short-term operating temperature RTI Elec.) |
| Ambient temperature (storage/transport) | -25 °C ... 60 °C (for a short time, not exceeding 24 h, -60 °C to +70 °C) |
| Ambient temperature (assembly) | -5 °C ... 70 °C |
| Ambient temperature (actuation) | -5 °C ... 70 °C |
| Permissible humidity (storage/transport) | 30 % ... 70 % |

Standards and regulations

| | |
|----------------------------------|-----------|
| Connection in acc. with standard | IEC 61984 |
|----------------------------------|-----------|

SPDB 2,5/ 1-L - Plug

3043190

<https://www.phoenixcontact.com/in/products/3043190>



Drawings

Schematic diagram

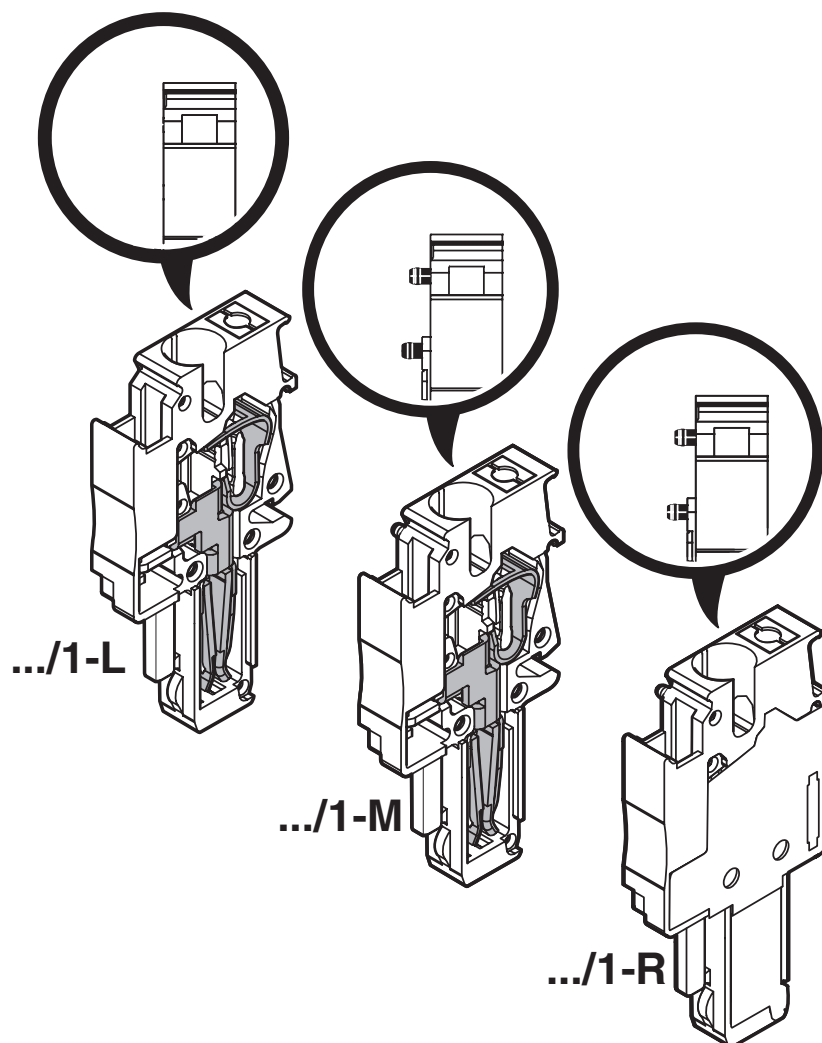

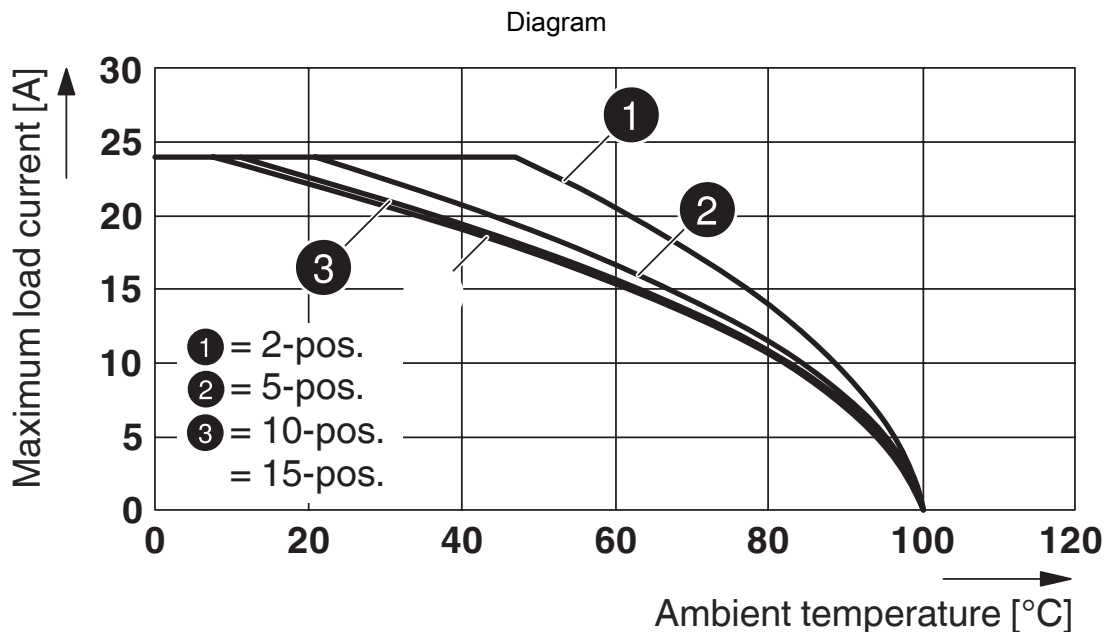

Derating curve for ST 2,5/ 1P, ST 2,5/ 2P, ST 2,5-TWIN/ 1P and for all plug versions SP...

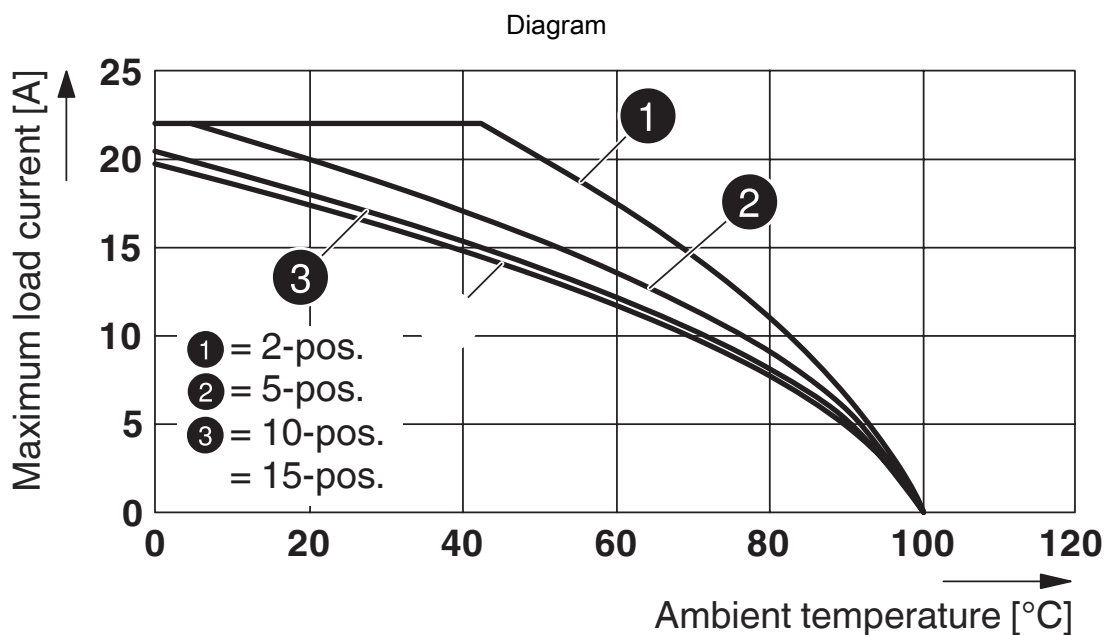

Derating curve for STTB 2,5/ 2P, STTB 2,5/ 2P-PV and for all plug versions SP...

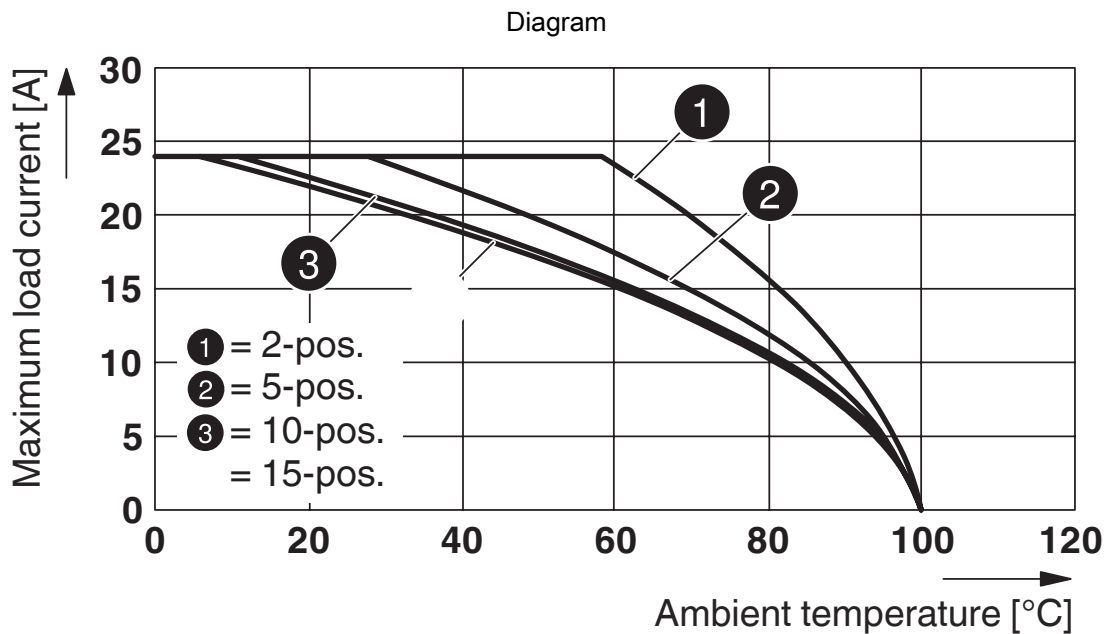

Derating curve for ST 2,5-QUATTRO/2P, ST 2,5-QUATTRO/4P and for all plug versions SP...

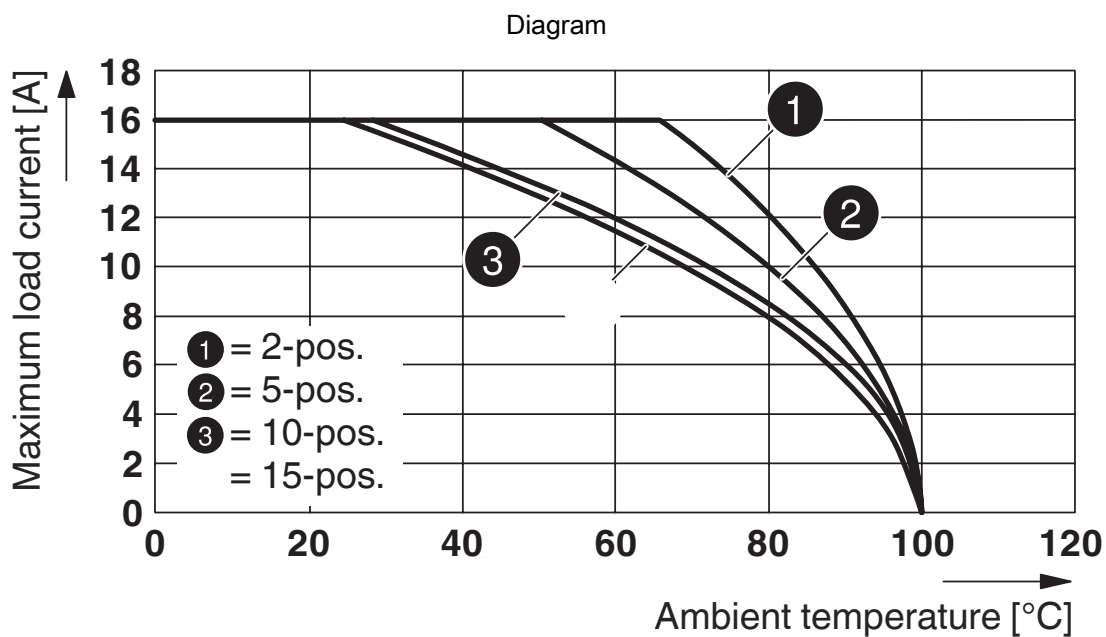

Derating curve for ST 2,5-TWIN-MT/1P, ST 2,5-TWIN-TG/1P and for all plug versions SP...

SPDB 2,5/ 1-L - Plug

3043190

<https://www.phoenixcontact.com/in/products/3043190>



Circuit diagram

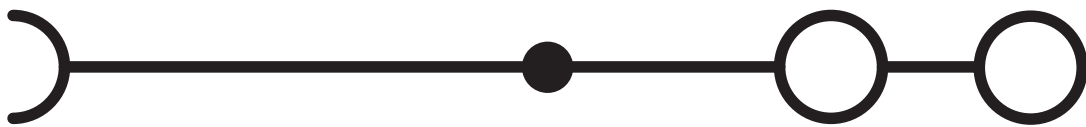

Diagram

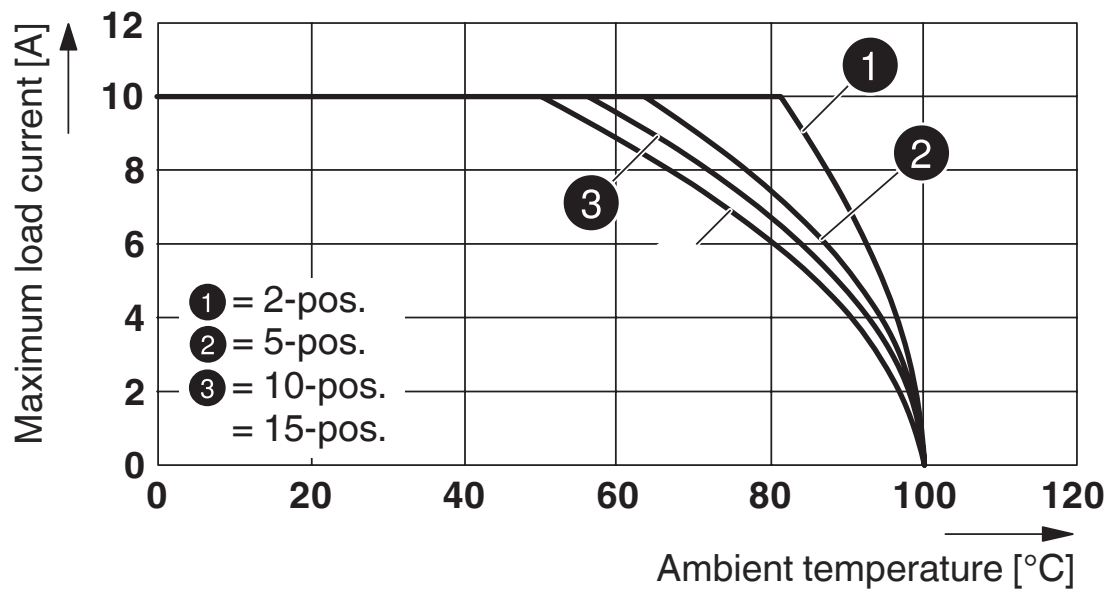

Derating curve for ST 2,5-4L/1P, ST 2,5-4L/2P and for all plug versions SP...

SPDB 2,5/ 1-L - Plug



3043190

<https://www.phoenixcontact.com/in/products/3043190>

Approvals

|  CSA Approval ID: 13631 | | | | |
|--|-----------------------|-----------------------|-------------------|----------------------|
| | Nominal Voltage U_N | Nominal Current I_N | Cross Section AWG | Cross Section mm^2 |
| Use group B | 300 V | 20 A | 28 - 12 | - |
| Use group C | 300 V | 20 A | 28 - 12 | - |
| Use group D | 600 V | 5 A | 28 - 12 | - |

|  IECEE CB Scheme Approval ID: DE1-62736/B1/B2 | | | | |
|--|--|--|--|--|
|--|--|--|--|--|

|  EAC Approval ID: RU C-DE.BL08.B.00511 | | | | |
|---|--|--|--|--|
|---|--|--|--|--|

|  LR Approval ID: LR2042068TA | | | | |
|---|--|--|--|--|
|---|--|--|--|--|

|  RS Approval ID: 22.44.01.00083.250 | | | | |
|--|--|--|--|--|
|--|--|--|--|--|

|  BV Approval ID: 27721/B0 BV | | | | |
|---|--|--|--|--|
|---|--|--|--|--|

|  VDE Zeichengenehmigung Approval ID: 40019518 | | | | |
|--|-----------------------|-----------------------|-------------------|----------------------|
| | Nominal Voltage U_N | Nominal Current I_N | Cross Section AWG | Cross Section mm^2 |
| Only flexible conductors | 500 V | - | - | 0.2 - 2.5 |
| Only rigid conductors | 500 V | - | - | 0.2 - 4 |

|  cULus Recognized Approval ID: E60425 | | | | |
|--|-----------------------|-----------------------|-------------------|----------------------|
| | Nominal Voltage U_N | Nominal Current I_N | Cross Section AWG | Cross Section mm^2 |
| Use group B | 300 V | 20 A | 26 - 12 | - |
| Use group C | | | | |

SPDB 2,5/ 1-L - Plug



3043190

<https://www.phoenixcontact.com/in/products/3043190>

| | | | | |
|-------------|-------|------|---------|---|
| | 300 V | 20 A | 26 - 12 | - |
| Use group D | | | | |
| | 600 V | 5 A | 26 - 12 | - |

SPDB 2,5/ 1-L - Plug

3043190

<https://www.phoenixcontact.com/in/products/3043190>



Classifications

ECLASS

| | |
|-------------|----------|
| ECLASS-11.0 | 27141151 |
| ECLASS-12.0 | 27141151 |
| ECLASS-13.0 | 27250306 |

ETIM

| | |
|----------|----------|
| ETIM 8.0 | EC002021 |
|----------|----------|

UNSPSC

| | |
|-------------|----------|
| UNSPSC 21.0 | 39121400 |
|-------------|----------|

SPDB 2,5/ 1-L - Plug

3043190

<https://www.phoenixcontact.com/in/products/3043190>



Environmental Product Compliance

| | |
|------------|---|
| China RoHS | Environmentally friendly use period: unlimited = EFUP-e |
| | No hazardous substances above threshold values |

SPDB 2,5/ 1-L - Plug

3043190

<https://www.phoenixcontact.com/in/products/3043190>



Accessories

i Note: Applying some accessories below might limit this product.

FBS 2-5 - Plug-in bridge

3030161

<https://www.phoenixcontact.com/in/products/3030161>



Plug-in bridge, pitch: 5.2 mm, number of positions: 2, length: 23 mm, color: red

i Max. current carrying capacity: 24 A

FBS 3-5 - Plug-in bridge

3030174

<https://www.phoenixcontact.com/in/products/3030174>



Plug-in bridge, pitch: 5.2 mm, number of positions: 3, length: 23 mm, color: red

i Max. current carrying capacity: 24 A

SPDB 2,5/ 1-L - Plug

3043190

<https://www.phoenixcontact.com/in/products/3043190>



FBS 4-5 - Plug-in bridge

3030187

<https://www.phoenixcontact.com/in/products/3030187>



Plug-in bridge, pitch: 5.2 mm, number of positions: 4, length: 23 mm, color: red

 Max. current carrying capacity: 24 A

FBS 5-5 - Plug-in bridge

3030190

<https://www.phoenixcontact.com/in/products/3030190>



Plug-in bridge, pitch: 5.2 mm, number of positions: 5, length: 23 mm, color: red

 Max. current carrying capacity: 24 A

SPDB 2,5/ 1-L - Plug

3043190

<https://www.phoenixcontact.com/in/products/3043190>



FBS 10-5 - Plug-in bridge

3030213

<https://www.phoenixcontact.com/in/products/3030213>



Plug-in bridge, pitch: 5.2 mm, number of positions: 10, length: 23 mm, color: red

 Max. current carrying capacity: 24 A

FBS 20-5 - Plug-in bridge

3030226

<https://www.phoenixcontact.com/in/products/3030226>



Plug-in bridge, pitch: 5.2 mm, number of positions: 20, color: red

 Max. current carrying capacity: 24 A

SPDB 2,5/ 1-L - Plug

3043190

<https://www.phoenixcontact.com/in/products/3043190>



FBS 50-5 - Plug-in bridge

3038930

<https://www.phoenixcontact.com/in/products/3038930>



Plug-in bridge, pitch: 5.2 mm, number of positions: 50, color: red

 Max. current carrying capacity: 24 A

FBS 2-5 BU - Plug-in bridge

3036877

<https://www.phoenixcontact.com/in/products/3036877>



Plug-in bridge, pitch: 5.2 mm, number of positions: 2, color: blue

 Max. current carrying capacity: 24 A

SPDB 2,5/ 1-L - Plug

3043190

<https://www.phoenixcontact.com/in/products/3043190>



FBS 3-5 BU - Plug-in bridge

3036880

<https://www.phoenixcontact.com/in/products/3036880>



Plug-in bridge, pitch: 5.2 mm, number of positions: 3, color: blue

 Max. current carrying capacity: 24 A

FBS 4-5 BU - Plug-in bridge

3036893

<https://www.phoenixcontact.com/in/products/3036893>



Plug-in bridge, pitch: 5.2 mm, number of positions: 4, color: blue

 Max. current carrying capacity: 24 A

SPDB 2,5/ 1-L - Plug

3043190

<https://www.phoenixcontact.com/in/products/3043190>

FBS 5-5 BU - Plug-in bridge

3036903

<https://www.phoenixcontact.com/in/products/3036903>



Plug-in bridge, pitch: 5.2 mm, number of positions: 5, color: blue

 Max. current carrying capacity: 24 A

FBS 10-5 BU - Plug-in bridge

3036916

<https://www.phoenixcontact.com/in/products/3036916>



Plug-in bridge, pitch: 5.2 mm, number of positions: 10, color: blue

 Max. current carrying capacity: 24 A

SPDB 2,5/ 1-L - Plug

3043190

<https://www.phoenixcontact.com/in/products/3043190>

FBS 20-5 BU - Plug-in bridge

3036929

<https://www.phoenixcontact.com/in/products/3036929>



Plug-in bridge, pitch: 5.2 mm, number of positions: 20, color: blue

 Max. current carrying capacity: 24 A

FBS 50-5 BU - Plug-in bridge

3032114

<https://www.phoenixcontact.com/in/products/3032114>



Plug-in bridge, pitch: 5.2 mm, number of positions: 50, color: blue

 Max. current carrying capacity: 24 A

SPDB 2,5/ 1-L - Plug

3043190

<https://www.phoenixcontact.com/in/products/3043190>



FBS 2-5 GY - Plug-in bridge

3038969

<https://www.phoenixcontact.com/in/products/3038969>



Plug-in bridge, pitch: 5.2 mm, number of positions: 2, color: gray

 Max. current carrying capacity: 24 A

FBS 3-5 GY - Plug-in bridge

3038972

<https://www.phoenixcontact.com/in/products/3038972>



Plug-in bridge, pitch: 5.2 mm, number of positions: 3, color: gray

 Max. current carrying capacity: 24 A

SPDB 2,5/ 1-L - Plug

3043190

<https://www.phoenixcontact.com/in/products/3043190>



FBS 4-5 GY - Plug-in bridge

3038985

<https://www.phoenixcontact.com/in/products/3038985>



Plug-in bridge, pitch: 5.2 mm, number of positions: 4, color: gray

 Max. current carrying capacity: 24 A

FBS 5-5 GY - Plug-in bridge

3038998

<https://www.phoenixcontact.com/in/products/3038998>



Plug-in bridge, pitch: 5.2 mm, number of positions: 5, color: gray

 Max. current carrying capacity: 24 A

SPDB 2,5/ 1-L - Plug

3043190

<https://www.phoenixcontact.com/in/products/3043190>



FBS 10-5 GY - Plug-in bridge

3039007

<https://www.phoenixcontact.com/in/products/3039007>



Plug-in bridge, pitch: 5.2 mm, number of positions: 10, color: gray

 Max. current carrying capacity: 24 A

FBS 20-5 GY - Plug-in bridge

3038671

<https://www.phoenixcontact.com/in/products/3038671>



Plug-in bridge, pitch: 5.2 mm, number of positions: 20, color: gray

 Max. current carrying capacity: 24 A

SPDB 2,5/ 1-L - Plug

3043190

<https://www.phoenixcontact.com/in/products/3043190>



FBS 50-5 GY - Plug-in bridge

3032127

<https://www.phoenixcontact.com/in/products/3032127>



Plug-in bridge, pitch: 5.2 mm, number of positions: 50, color: gray

 Max. current carrying capacity: 24 A

FBSR 2-5 - Plug-in bridge

3033702

<https://www.phoenixcontact.com/in/products/3033702>



Plug-in bridge, pitch: 5.2 mm, number of positions: 2, color: red

 Max. current carrying capacity: 17.5 A

SPDB 2,5/ 1-L - Plug

3043190

<https://www.phoenixcontact.com/in/products/3043190>



FBSR 3-5 - Plug-in bridge

3001591

<https://www.phoenixcontact.com/in/products/3001591>



Plug-in bridge, pitch: 5.2 mm, number of positions: 3, color: red

 Max. current carrying capacity: 17.5 A

FBSR 4-5 - Plug-in bridge

3001592

<https://www.phoenixcontact.com/in/products/3001592>



Plug-in bridge, pitch: 5.2 mm, number of positions: 4, color: red

 Max. current carrying capacity: 17.5 A

SPDB 2,5/ 1-L - Plug

3043190

<https://www.phoenixcontact.com/in/products/3043190>



FBSR 5-5 - Plug-in bridge

3001593

<https://www.phoenixcontact.com/in/products/3001593>



Plug-in bridge, pitch: 5.2 mm, number of positions: 5, color: red

 Max. current carrying capacity: 17.5 A

FBSR 10-5 - Plug-in bridge

3033710

<https://www.phoenixcontact.com/in/products/3033710>



Plug-in bridge, pitch: 5.2 mm, number of positions: 10, color: red

 Max. current carrying capacity: 17.5 A

SPDB 2,5/ 1-L - Plug

3043190

<https://www.phoenixcontact.com/in/products/3043190>



PDZ/2 - Strain relief

3040562

<https://www.phoenixcontact.com/in/products/3040562>



Strain relief, length: 28.9 mm, width: 9.6 mm, number of positions: 2, color: black

PDZ/4 - Strain relief

3040575

<https://www.phoenixcontact.com/in/products/3040575>



Strain relief, length: 28.9 mm, width: 19.8 mm, number of positions: 4, color: black

SPDB 2,5/ 1-L - Plug

3043190

<https://www.phoenixcontact.com/in/products/3043190>



PR - Latching

3040559

<https://www.phoenixcontact.com/in/products/3040559>



Latching, length: 29.8 mm, width: 4.4 mm, number of positions: 1, color: orange

PR/2 - Latching

3040630

<https://www.phoenixcontact.com/in/products/3040630>



Latching, length: 29.8 mm, width: 10 mm, number of positions: 2, color: orange

SPDB 2,5/ 1-L - Plug

3043190

<https://www.phoenixcontact.com/in/products/3043190>



PRT/2 - Latching

3040631

<https://www.phoenixcontact.com/in/products/3040631>



Latching, can only be released using a screwdriver, length: 23.2 mm, width: 9 mm, number of positions: 2, color: orange

PRZ - Latching

3040614

<https://www.phoenixcontact.com/in/products/3040614>



Latching, number of positions: 2, length: 64 mm, color: orange

SPDB 2,5/ 1-L - Plug

3043190

<https://www.phoenixcontact.com/in/products/3043190>

PSH 3- 6 - Shield connection clamp

3040591

<https://www.phoenixcontact.com/in/products/3040591>



Shield connection clamp, color: black

PSH 5-10 - Shield connection clamp

3040601

<https://www.phoenixcontact.com/in/products/3040601>



Shield connection clamp, color: black

SPDB 2,5/ 1-L - Plug

3043190

<https://www.phoenixcontact.com/in/products/3043190>



DFS-SPDB 2,5 - Flange cover

3061457

<https://www.phoenixcontact.com/in/products/3061457>



Flange cover, length: 35.8 mm, width: 4.5 mm, height: 24.7 mm, color: gray

B-STIFT - Marker pen

1051993

<https://www.phoenixcontact.com/in/products/1051993>



Marker pen, for manual labeling of unprinted Zack strips, smear-proof and waterproof, line thickness 0.5 mm

SPDB 2,5/ 1-L - Plug

3043190

<https://www.phoenixcontact.com/in/products/3043190>



X-PEN 0,35 - Marker pen

0811228

<https://www.phoenixcontact.com/in/products/0811228>



Marker pen without ink cartridge, for manual labeling of markers, labeling extremely wipe-proof, line thickness 0.35 mm

ST-BW - Actuation tool

1207608

<https://www.phoenixcontact.com/in/products/1207608>



Actuation tool, for all 2.5 mm² - 4.0 mm² spring-cages

SPDB 2,5/ 1-L - Plug

3043190

<https://www.phoenixcontact.com/in/products/3043190>



ZBF 5:UNBEDRUCKT - Zack Marker strip, flat

0808642

<https://www.phoenixcontact.com/in/products/0808642>



Zack Marker strip, flat, Strip, white, unlabeled, can be labeled with: PLOTMARK, CMS-P1-PLOTTER, mounting type: snapped, for terminal block width: 5 mm, lettering field size: 5.1 x 5.2 mm, Number of individual labels: 10

ZBF 5 CUS - Zack Marker strip, flat

0825025

<https://www.phoenixcontact.com/in/products/0825025>



Zack Marker strip, flat, can be ordered: Strip, white, labeled according to customer specifications, mounting type: snap into flat marker groove, for terminal block width: 5 mm, lettering field size: 5.15 x 5.15 mm, Number of individual labels: 10

SPDB 2,5/ 1-L - Plug

3043190

<https://www.phoenixcontact.com/in/products/3043190>



ZBF 5,LGS:FORTL.ZAHLEN - Zack Marker strip, flat

0808671

<https://www.phoenixcontact.com/in/products/0808671>



Zack Marker strip, flat, Strip, white, labeled, printed horizontally: consecutive numbers 1 ... 10, 11 ... 20, etc. up to 491 ... 500, mounting type: snapped, for terminal block width: 5 mm, lettering field size: 5.15 x 5.15 mm, Number of individual labels: 10

ZBF 5,QR:FORTL.ZAHLEN - Zack Marker strip, flat

0808697

<https://www.phoenixcontact.com/in/products/0808697>



Zack Marker strip, flat, Strip, white, labeled, Printed vertically: consecutive numbers 1 ... 10, 11 ... 20, etc. up to 91 ... 100, mounting type: snapped, for terminal block width: 5 mm, lettering field size: 5.15 x 5.15 mm, Number of individual labels: 10

SPDB 2,5/ 1-L - Plug

3043190

<https://www.phoenixcontact.com/in/products/3043190>



ZBF 5,LGS:GERADE ZAHLEN - Zack Marker strip, flat

0810821

<https://www.phoenixcontact.com/in/products/0810821>



Zack Marker strip, flat, Strip, white, labeled, printed horizontally: consecutive even numbers 2 ... 20, 22 ... 40, etc. up to 82 ... 100, mounting type: snapped, for terminal block width: 5 mm, lettering field size: 5.15 x 5.15 mm, Number of individual labels: 10

ZBF 5,LGS:UNGERADE ZAHLEN - Zack Marker strip, flat

0810863

<https://www.phoenixcontact.com/in/products/0810863>



Zack Marker strip, flat, Strip, white, labeled, printed horizontally: Odd numbers 1 - 19, 21 - 39, etc. up to 81 - 99, mounting type: snapped, for terminal block width: 5 mm, lettering field size: 5.15 x 5.15 mm, Number of individual labels: 10

SPDB 2,5/ 1-L - Plug

3043190

<https://www.phoenixcontact.com/in/products/3043190>



UC-TMF 5 - Marker for terminal blocks

0818153

<https://www.phoenixcontact.com/in/products/0818153>



Marker for terminal blocks, Sheet, white, unlabeled, can be labeled with: BLUEMARK ID COLOR, BLUEMARK ID, BLUEMARK CLED, PLOTMARK, CMS-P1-PLOTTER, mounting type: snapped, for terminal block width: 5.2 mm, lettering field size: 4.6 x 5.1 mm, Number of individual labels: 96

UC-TMF 5 CUS - Marker for terminal blocks

0824638

<https://www.phoenixcontact.com/in/products/0824638>



Marker for terminal blocks, can be ordered: by sheet, white, labeled according to customer specifications, mounting type: snap into flat marker groove, for terminal block width: 5.2 mm, lettering field size: 4.6 x 5.1 mm, Number of individual labels: 96

SPDB 2,5/ 1-L - Plug

3043190

<https://www.phoenixcontact.com/in/products/3043190>



UCT-TMF 5 - Marker for terminal blocks

0828744

<https://www.phoenixcontact.com/in/products/0828744>



Marker for terminal blocks, Sheet, white, unlabeled, can be labeled with: TOPMARK NEO, TOPMARK LASER, BLUEMARK ID COLOR, BLUEMARK ID, BLUEMARK CLED, THERMOMARK PRIME, THERMOMARK CARD 2.0, THERMOMARK CARD, mounting type: snapped, for terminal block width: 5.2 mm, lettering field size: 4.4 x 4.7 mm, Number of individual labels: 72

UCT-TMF 5 CUS - Marker for terminal blocks

0829658

<https://www.phoenixcontact.com/in/products/0829658>



Marker for terminal blocks, can be ordered: by sheet, white, labeled according to customer specifications, mounting type: snap into flat marker groove, for terminal block width: 5.2 mm, lettering field size: 4.4 x 4.7 mm, Number of individual labels: 72

SPDB 2,5/ 1-L - Plug

3043190

<https://www.phoenixcontact.com/in/products/3043190>



ISH 2,5/0,2 - Insulating sleeve

3002843

<https://www.phoenixcontact.com/in/products/3002843>



Insulating sleeve, color: white

ISH 2,5/0,5 - Insulating sleeve

3002856

<https://www.phoenixcontact.com/in/products/3002856>



Insulating sleeve, color: gray

SPDB 2,5/ 1-L - Plug

3043190

<https://www.phoenixcontact.com/in/products/3043190>



ISH 2,5/1,0 - Insulating sleeve

3002869

<https://www.phoenixcontact.com/in/products/3002869>



Insulating sleeve, color: black

Phoenix Contact 2023 © - all rights reserved

<https://www.phoenixcontact.com>

PHOENIX CONTACT (I) Pvt. Ltd.

A-58/2, Okhla Industrial Area, Phase - II, New Delhi-110 020

+91.1275.71420

info@phoenixcontact.co.in