

# SP-H 2,5/ 1-L - Plug

3210787

<https://www.phoenixcontact.com/in/products/3210787>



Please be informed that the data shown in this PDF document is generated from our Online Catalog. Please find the complete data in the user documentation. Our General Terms of Use for Downloads are valid.



Plug, nom. voltage: 500 V, nominal current: 24 A, number of positions: 1, connection method: Spring-cage connection, Rated cross section: 2.5 mm<sup>2</sup>, cross section: 0.08 mm<sup>2</sup>- 4 mm<sup>2</sup>, color: gray

## Product Description

Connector element left, left housing without engagement pin, right opened without cover

## Your advantages

- Cable housing can be snapped on to the plugs, see figure below
- The plug with spring-cage connection is assembled directly on site by snapping together single-position plug elements
- The ST-COMBI plugs for self-assembly provide solutions that users can implement themselves
- Tested for railway applications

## Commercial Data

Item number	3210787
Packing unit	50 pc
Minimum order quantity	50 pc
Sales Key	BE2
Product Key	BE2144
Catalog Page	Page 319 (C-1-2019)
GTIN	4046356411776
Weight per Piece (including packing)	2.98 g
Weight per Piece (excluding packing)	2.98 g
Customs tariff number	85366990
Country of origin	PL

# SP-H 2,5/ 1-L - Plug



3210787

<https://www.phoenixcontact.com/in/products/3210787>

## Technical Data

### Product properties

Product type	Terminal plug
Number of positions	1
Pitch	5.2 mm
Potentials	1

### Insulation characteristics

Overvoltage category	III
Degree of pollution	3

### Electrical properties

Rated surge voltage	6 kV
---------------------	------

### Connection data

Nominal cross section	2.5 mm <sup>2</sup>
Stripping length	8 mm ... 10 mm
Internal cylindrical gage	A3
Connection in acc. with standard	IEC 61984
Conductor cross section rigid	0.08 mm <sup>2</sup> ... 4 mm <sup>2</sup>
Cross section AWG	28 ... 12 (converted acc. to IEC)
Conductor cross section flexible	0.08 mm <sup>2</sup> ... 2.5 mm <sup>2</sup>
Conductor cross section, flexible [AWG]	28 ... 14 (converted acc. to IEC)
Conductor cross-section flexible (ferrule without plastic sleeve)	0.14 mm <sup>2</sup> ... 2.5 mm <sup>2</sup>
Flexible conductor cross section (ferrule with plastic sleeve)	0.14 mm <sup>2</sup> ... 2.5 mm <sup>2</sup>
2 conductors with the same cross section, flexible, with TWIN ferrule with plastic sleeve	0.5 mm <sup>2</sup>
Nominal current	24 A
Maximum load current	24 A (with 4 mm <sup>2</sup> conductor cross section)
Nominal voltage	500 V
Nominal cross section	2.5 mm <sup>2</sup>

### Dimensions

Width	5.2 mm
Height	39 mm
Length	15.8 mm
Pitch	5.2 mm

### Material specifications

Color	gray
Flammability rating according to UL 94	V0
Insulating material group	I
Insulating material	PA

# SP-H 2,5/ 1-L - Plug



3210787

<https://www.phoenixcontact.com/in/products/3210787>

Static insulating material application in cold	-60 °C
Temperature index of insulation material (DIN EN 60216-1 (VDE 0304-21))	130 °C
Relative insulation material temperature index (Elec., UL 746 B)	130 °C
Fire protection for rail vehicles (DIN EN 45545-2) R22	HL 1 - HL 3
Fire protection for rail vehicles (DIN EN 45545-2) R23	HL 1 - HL 3
Fire protection for rail vehicles (DIN EN 45545-2) R24	HL 1 - HL 3
Fire protection for rail vehicles (DIN EN 45545-2) R26	HL 1 - HL 3
Calorimetric heat release NFPA 130 (ASTM E 1354)	28 MJ/kg
Surface flammability NFPA 130 (ASTM E 162)	passed
Specific optical density of smoke NFPA 130 (ASTM E 662)	passed
Smoke gas toxicity NFPA 130 (SMP 800C)	passed

## Environmental and real-life conditions

### Ambient conditions

Ambient temperature (operation)	-60 °C ... 105 °C (max. short-term operating temperature RTI Elec.)
Ambient temperature (storage/transport)	-25 °C ... 60 °C (for a short time, not exceeding 24 h, -60 °C to +70 °C)
Ambient temperature (assembly)	-5 °C ... 70 °C
Ambient temperature (actuation)	-5 °C ... 70 °C
Permissible humidity (storage/transport)	30 % ... 70 %

## Standards and regulations

Connection in acc. with standard	IEC 61984
----------------------------------	-----------

# SP-H 2,5/ 1-L - Plug

3210787

<https://www.phoenixcontact.com/in/products/3210787>



## Drawings

Schematic diagram

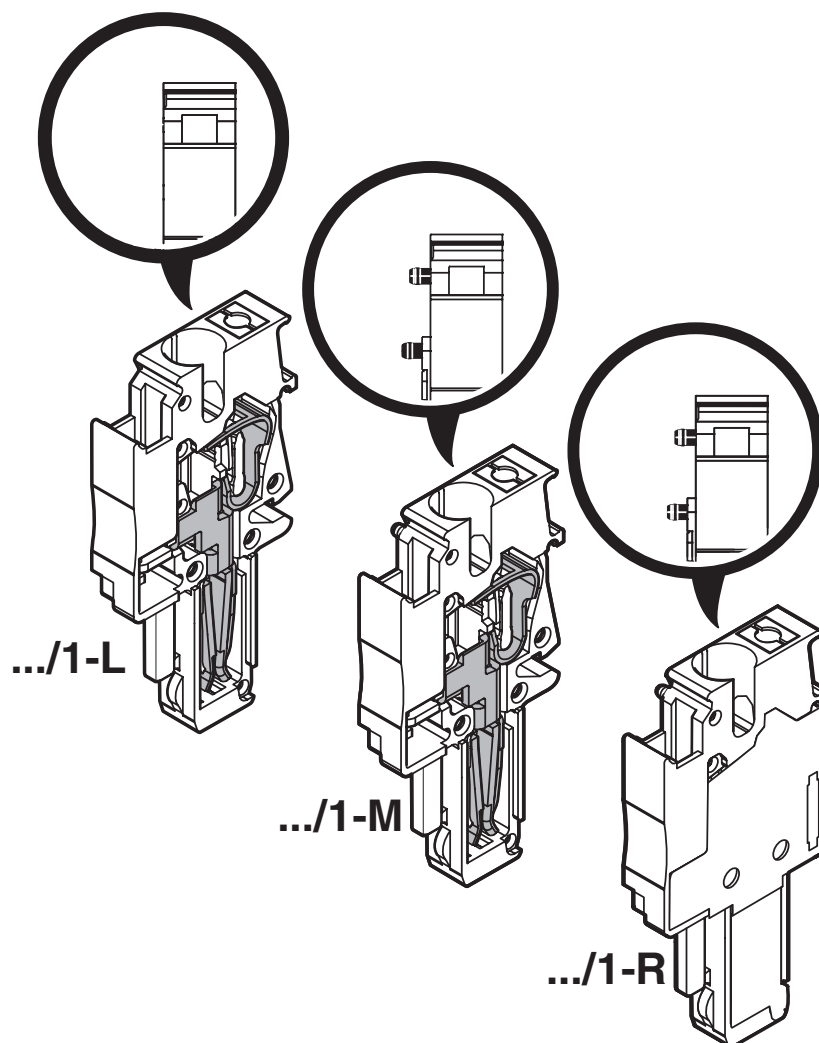

Diagram

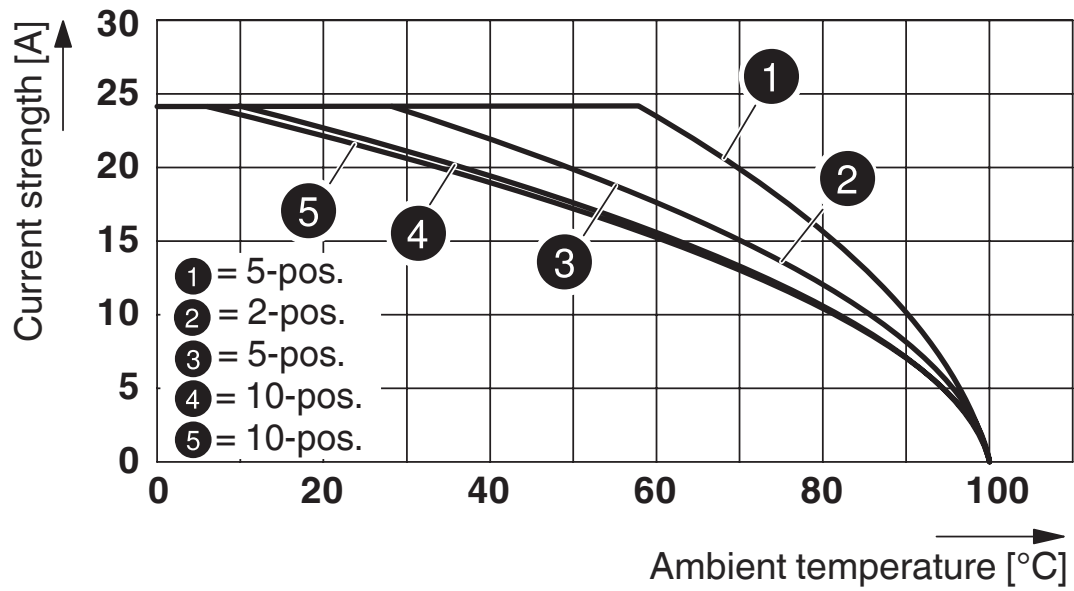

Circuit diagram



# SP-H 2,5/ 1-L - Plug





3210787

<https://www.phoenixcontact.com/in/products/3210787>

## Approvals

 <b>CSA</b> Approval ID: 13631				
	Nominal Voltage $U_N$	Nominal Current $I_N$	Cross Section AWG	Cross Section $\text{mm}^2$
Use group B				
	300 V	20 A	26 - 12	-
Use group C				
	300 V	20 A	26 - 12	-

 <b>IECEE CB Scheme</b> Approval ID: DE1-62736/B1/B2				
--	--	--	--	--

 <b>EAC</b> Approval ID: RU C-DE.BL08.B.00511				
---	--	--	--	--

 <b>VDE Zeichengenehmigung</b> Approval ID: 40019518				
	Nominal Voltage $U_N$	Nominal Current $I_N$	Cross Section AWG	Cross Section $\text{mm}^2$
Only flexible conductors	500 V	-	-	0.2 - 2.5
Only rigid conductors	500 V	-	-	0.2 - 4

 <b>cULus Recognized</b> Approval ID: E60425				
--	--	--	--	--

 <b>cULus Recognized</b> Approval ID: E60425				
--	--	--	--	--

# SP-H 2,5/ 1-L - Plug

3210787

<https://www.phoenixcontact.com/in/products/3210787>



## Classifications

### ECLASS

ECLASS-11.0	27141151
ECLASS-12.0	27141151
ECLASS-13.0	27250306

### ETIM

ETIM 8.0	EC002021
----------	----------

### UNSPSC

UNSPSC 21.0	39121400
-------------	----------

# SP-H 2,5/ 1-L - Plug

3210787

<https://www.phoenixcontact.com/in/products/3210787>



## Environmental Product Compliance

China RoHS	Environmentally friendly use period: unlimited = EFUP-e
	No hazardous substances above threshold values



# SP-H 2,5/ 1-L - Plug

3210787

<https://www.phoenixcontact.com/in/products/3210787>



## Accessories

### PZ/2 - Strain relief

3040627

<https://www.phoenixcontact.com/in/products/3040627>



Strain relief, length: 48.7 mm, width: 9.3 mm, number of positions: 2, color: black

---

### PZ/4 - Strain relief

3040643

<https://www.phoenixcontact.com/in/products/3040643>



Strain relief, length: 48.7 mm, width: 19.6 mm, number of positions: 4, color: black

## SP-H 2,5/ 1-L - Plug

3210787

<https://www.phoenixcontact.com/in/products/3210787>



### PR - Latching

3040559

<https://www.phoenixcontact.com/in/products/3040559>



Latching, length: 29.8 mm, width: 4.4 mm, number of positions: 1, color: orange

---

### PR/2 - Latching

3040630

<https://www.phoenixcontact.com/in/products/3040630>



Latching, length: 29.8 mm, width: 10 mm, number of positions: 2, color: orange

# SP-H 2,5/ 1-L - Plug

3210787

<https://www.phoenixcontact.com/in/products/3210787>



## PRT/2 - Latching

3040631

<https://www.phoenixcontact.com/in/products/3040631>



Latching, can only be released using a screwdriver, length: 23.2 mm, width: 9 mm, number of positions: 2, color: orange

---

## PRZ - Latching

3040614

<https://www.phoenixcontact.com/in/products/3040614>



Latching, number of positions: 2, length: 64 mm, color: orange

# SP-H 2,5/ 1-L - Plug

3210787

<https://www.phoenixcontact.com/in/products/3210787>



## PSH 3- 6 - Shield connection clamp

3040591

<https://www.phoenixcontact.com/in/products/3040591>



Shield connection clamp, color: black

---

## PSH 5-10 - Shield connection clamp

3040601

<https://www.phoenixcontact.com/in/products/3040601>



Shield connection clamp, color: black

# SP-H 2,5/ 1-L - Plug

3210787

<https://www.phoenixcontact.com/in/products/3210787>



## DF-SP-H 2,5 - Flange cover

3209824

<https://www.phoenixcontact.com/in/products/3209824>

Flange cover, length: 35.8 mm, width: 4.5 mm, height: 24.7 mm, color: gray



---

## PH 2,5/ 2 - Cable housing

3209691

<https://www.phoenixcontact.com/in/products/3209691>

Cable housing, pitch: 10.4 mm, length: 19.9 mm, width: 10.4 mm, height: 36.8 mm, number of positions: 2, color: gray



# SP-H 2,5/ 1-L - Plug

3210787

<https://www.phoenixcontact.com/in/products/3210787>



## PH 2,5/ 3 - Cable housing

3209701

<https://www.phoenixcontact.com/in/products/3209701>



Cable housing, pitch: 15.6 mm, length: 19.9 mm, width: 15.6 mm, height: 36.8 mm, number of positions: 3, color: gray

---

## PH 2,5/ 4 - Cable housing

3209714

<https://www.phoenixcontact.com/in/products/3209714>



Cable housing, pitch: 20.8 mm, length: 19.9 mm, width: 20.8 mm, height: 36.8 mm, number of positions: 4, color: gray

# SP-H 2,5/ 1-L - Plug

3210787

<https://www.phoenixcontact.com/in/products/3210787>



## PH 2,5/ 5 - Cable housing

3209727

<https://www.phoenixcontact.com/in/products/3209727>



Cable housing, pitch: 26 mm, length: 19.9 mm, width: 26 mm, height: 36.8 mm, number of positions: 5, color: gray

---

## PH 2,5/ 6 - Cable housing

3209730

<https://www.phoenixcontact.com/in/products/3209730>



Cable housing, pitch: 31.2 mm, length: 19.9 mm, width: 31.2 mm, height: 36.8 mm, number of positions: 6, color: gray

# SP-H 2,5/ 1-L - Plug

3210787

<https://www.phoenixcontact.com/in/products/3210787>



## PH 2,5/ 7 - Cable housing

3209743

<https://www.phoenixcontact.com/in/products/3209743>



Cable housing, pitch: 36.4 mm, length: 19.9 mm, width: 36.4 mm, height: 36.8 mm, number of positions: 7, color: gray

---

## PH 2,5/ 8 - Cable housing

3209756

<https://www.phoenixcontact.com/in/products/3209756>



Cable housing, pitch: 41.6 mm, length: 19.9 mm, width: 41.6 mm, height: 36.8 mm, number of positions: 8, color: gray



# SP-H 2,5/ 1-L - Plug

3210787

<https://www.phoenixcontact.com/in/products/3210787>



## PH 2,5/ 9 - Cable housing

3209507

<https://www.phoenixcontact.com/in/products/3209507>

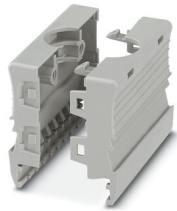

Cable housing, pitch: 46.8 mm, length: 19.9 mm, width: 46.8 mm, height: 36.8 mm, number of positions: 9, color: gray

---

## PH 2,5/10 - Cable housing

3209769

<https://www.phoenixcontact.com/in/products/3209769>



Cable housing, pitch: 52 mm, length: 19.9 mm, width: 52 mm, height: 36.8 mm, number of positions: 10, color: gray

# SP-H 2,5/ 1-L - Plug

3210787

<https://www.phoenixcontact.com/in/products/3210787>



## PH 2,5/11 - Cable housing

3209772

<https://www.phoenixcontact.com/in/products/3209772>

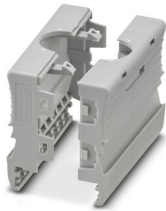

Cable housing, pitch: 57.2 mm, length: 19.9 mm, width: 57.2 mm, height: 36.8 mm, number of positions: 11, color: gray

---

## PH 2,5/12 - Cable housing

3209785

<https://www.phoenixcontact.com/in/products/3209785>

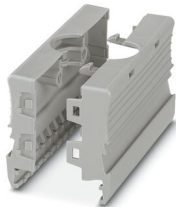

Cable housing, pitch: 62.4 mm, length: 19.9 mm, width: 62.4 mm, height: 36.8 mm, number of positions: 12, color: gray

# SP-H 2,5/ 1-L - Plug

3210787

<https://www.phoenixcontact.com/in/products/3210787>



## PH 2,5/13 - Cable housing

3209798

<https://www.phoenixcontact.com/in/products/3209798>

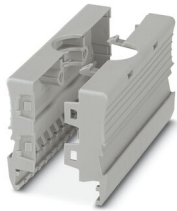

Cable housing, pitch: 67.6 mm, length: 19.9 mm, width: 67.6 mm, height: 36.8 mm, number of positions: 13, color: gray

---

## PH 2,5/14 - Cable housing

3209808

<https://www.phoenixcontact.com/in/products/3209808>

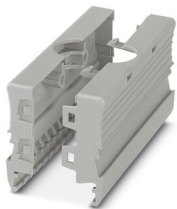

Cable housing, pitch: 72.8 mm, length: 19.9 mm, width: 72.8 mm, height: 36.8 mm, number of positions: 14, color: gray

# SP-H 2,5/ 1-L - Plug

3210787

<https://www.phoenixcontact.com/in/products/3210787>



## PH 2,5/15 - Cable housing

3209811

<https://www.phoenixcontact.com/in/products/3209811>



Cable housing, pitch: 78 mm, length: 19.9 mm, width: 78 mm, height: 36.8 mm, number of positions: 15, color: gray

---

## DFS-SP-H 2,5 - Flange cover

3061431

<https://www.phoenixcontact.com/in/products/3061431>



Flange cover, length: 35.8 mm, width: 4.5 mm, height: 24.7 mm, color: gray

# SP-H 2,5/ 1-L - Plug

3210787

<https://www.phoenixcontact.com/in/products/3210787>



## ST-BW - Actuation tool

1207608

<https://www.phoenixcontact.com/in/products/1207608>

Actuation tool, for all 2.5 mm<sup>2</sup> - 4.0 mm<sup>2</sup> spring-cages



---

## MPS-MT - Test plugs

0201744

<https://www.phoenixcontact.com/in/products/0201744>

Test plugs, with solder connection up to 1 mm<sup>2</sup> conductor cross section, number of positions: 1, fuse type: , mounting type: , , color: gray



# SP-H 2,5/ 1-L - Plug

3210787

<https://www.phoenixcontact.com/in/products/3210787>



## MPS-IH WH - Insulating sleeve

0201663

<https://www.phoenixcontact.com/in/products/0201663>

Insulating sleeve, fuse type: , mounting type: , , color: white



---

## MPS-IH RD - Insulating sleeve

0201676

<https://www.phoenixcontact.com/in/products/0201676>

Insulating sleeve, fuse type: , mounting type: , , color: red



# SP-H 2,5/ 1-L - Plug

3210787

<https://www.phoenixcontact.com/in/products/3210787>



## MPS-IH BU - Insulating sleeve

0201689

<https://www.phoenixcontact.com/in/products/0201689>

Insulating sleeve, fuse type: , mounting type: , , color: blue

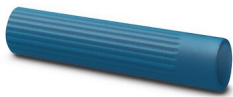

---

## MPS-IH YE - Insulating sleeve

0201692

<https://www.phoenixcontact.com/in/products/0201692>

Insulating sleeve, fuse type: , mounting type: , , color: yellow



# SP-H 2,5/ 1-L - Plug

3210787

<https://www.phoenixcontact.com/in/products/3210787>

## MPS-IH GN - Insulating sleeve

0201702

<https://www.phoenixcontact.com/in/products/0201702>

Insulating sleeve, fuse type: , mounting type: , , color: green



---

## MPS-IH GY - Insulating sleeve

0201728

<https://www.phoenixcontact.com/in/products/0201728>

Insulating sleeve, fuse type: , mounting type: , , color: gray





## SP-H 2,5/ 1-L - Plug

3210787

<https://www.phoenixcontact.com/in/products/3210787>



## MPS-IH BK - Insulating sleeve

0201731

<https://www.phoenixcontact.com/in/products/0201731>

Insulating sleeve, fuse type: , mounting type: , , color: black



---

## ISH 2,5/0,2 - Insulating sleeve

3002843

<https://www.phoenixcontact.com/in/products/3002843>

Insulating sleeve, color: white



# SP-H 2,5/ 1-L - Plug

3210787

<https://www.phoenixcontact.com/in/products/3210787>



## ISH 2,5/0,5 - Insulating sleeve

3002856

<https://www.phoenixcontact.com/in/products/3002856>



Insulating sleeve, color: gray

---

## ISH 2,5/1,0 - Insulating sleeve

3002869

<https://www.phoenixcontact.com/in/products/3002869>



Insulating sleeve, color: black

---

Phoenix Contact 2023 © - all rights reserved  
<https://www.phoenixcontact.com>

PHOENIX CONTACT (I) Pvt. Ltd.  
A-58/2, Okhla Industrial Area, Phase - II, New Delhi-110 020

+91.1275.71420  
[info@phoenixcontact.co.in](mailto:info@phoenixcontact.co.in)