

Product data sheet

Specifications



three-phase network control relay RM4-T - range 300..430 V

RM4TU02

! Discontinued on: 31 December 2016

! Discontinued

Main

Range of product	Harmony Relay
Product or component type	Industrial measurement and control relays
Relay type	Control relay
Product specific application	For 3-phase supply
Relay name	RM4-T
Relay monitored parameters	Phase sequence Undervoltage detection Phase failure detection
Time delay	Without
Measurement range	290...484 V
Contacts type and composition	2 C/O
Poles description	3P

Complementary

Maximum switching voltage	440 V AC
Control threshold undervoltage	300...430 V
Output contacts	2 C/O
Setting accuracy of the switching threshold	+/-3 %
Switching threshold drift	<= 0.06 % per degree centigrade depending permissible ambient air temperature <= 0.5 % within the measuring range
Setting accuracy of time delay	10 P
Time delay drift	<= 0.07 % per degree centigrade depending on the rated operational temperature <= 0.5 % within the measuring range
Hysteresis	5 % fixed of de-energisation threshold
Delay at power up	650 ms
Maximum measuring cycle	80 ms
Marking	CE
Overvoltage category	III conforming to IEC 60664-1
[Ui] rated insulation voltage	500 V conforming to IEC
Supply frequency	50/60 Hz +/- 5 %

Operating position	Any position without derating
Connections - terminals	Screw terminals, 2 x 1.5 mm ² flexible with cable end Screw terminals, 2 x 2.5 mm ² flexible without cable end
Tightening torque	0.6...1.1 N.m
Mechanical durability	30000000 cycles
[I_{th}] conventional free air thermal current	8 A
[I_e] rated operational current	2 A at 70 °C 24 V DC-13 conforming to IEC 60947-5-1/1991 2 A at 70 °C 24 V DC-13 conforming to VDE 0660 3 A at 70 °C 115 V AC-15 conforming to IEC 60947-5-1/1991 3 A at 70 °C 115 V AC-15 conforming to VDE 0660 3 A at 70 °C 24 V AC-15 conforming to IEC 60947-5-1/1991 3 A at 70 °C 24 V AC-15 conforming to VDE 0660 3 A at 70 °C 250 V AC-15 conforming to IEC 60947-5-1/1991 3 A at 70 °C 250 V AC-15 conforming to VDE 0660 0.1 A at 70 °C 250 V DC-13 conforming to IEC 60947-5-1/1991 0.1 A at 70 °C 250 V DC-13 conforming to VDE 0660 0.3 A at 70 °C 115 V DC-13 conforming to IEC 60947-5-1/1991 0.3 A at 70 °C 115 V DC-13 conforming to VDE 0660
Switching capacity in mA	10 mA at 12 V
Switching voltage	250 V AC
Contacts material	90/10 silver nickel contacts
Number of cables	2
Height	78 mm
Width	22.5 mm
Depth	80 mm
Terminals description ISO n°1	ALT (25-26-28)OC (L1-L2-L3)CO (15-16-18)OC
Output relay state	Tripped, fault present
9 mm pitches	2.5
Net weight	0.11 kg
Terminals description ISO n°2	(L1-L2-L3)CO (11-12-14)OC (21-22-24)OC ALT
Environment	
Electromagnetic compatibility	Electrostatic discharge - test level: 6 kV level 3 (contact discharge) conforming to IEC 61000-4-2 Electrostatic discharge - test level: 8 kV level 3 (air discharge) conforming to IEC 61000-4-2 Resistance to electrostatic discharge - test level: 6 kV (contact) conforming to IEC 61000-4-2 level 3 Resistance to electrostatic discharge - test level: 8 kV (air) conforming to IEC 61000-4-2 level 3
Standards	EN/IEC 60255-6
Product certifications	CSA GL UL
Directives	73/23/EEC - low voltage directive 89/336/EEC - electromagnetic compatibility
Ambient air temperature for storage	-40...85 °C
Ambient air temperature for operation	-20...65 °C
Relative humidity	15...85 % 3K3 conforming to IEC 60721-3-3
Vibration resistance	0.35 ms (f= 10...55 Hz) conforming to IEC 60068-2-6
Shock resistance	15 gn for 11 ms conforming to IEC 60068-2-27
IP degree of protection	IP20 (terminals) conforming to IEC 60529 IP50 (casing) conforming to IEC 60529

Pollution degree	3 conforming to IEC 60664-1
Dielectric test voltage	2.5 kV
Non-dissipating shock wave	4.8 kV
Resistance to electrostatic discharge	6 kV contact conforming to IEC 61000-4-2 level 3 8 kV air conforming to IEC 61000-4-2 level 3
Resistance to electromagnetic fields	10 V/m conforming to IEC 61000-4-3 level 3
Resistance to fast transients	2 kV conforming to IEC 61000-4-4 level 3
Disturbance radiated/ conducted	CISPR 22 - class A CISPR 11 group 1 - class A

Packing Units

Unit Type of Package 1	PCE
Number of Units in Package 1	1

Contractual warranty

Warranty	18 months
-----------------	-----------

3-phase Supply Control Relays

Dimensions

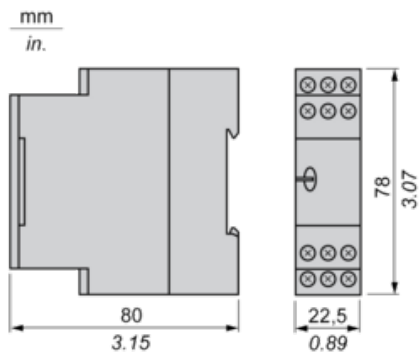

3-phase Supply Control Relays

Rail mounting

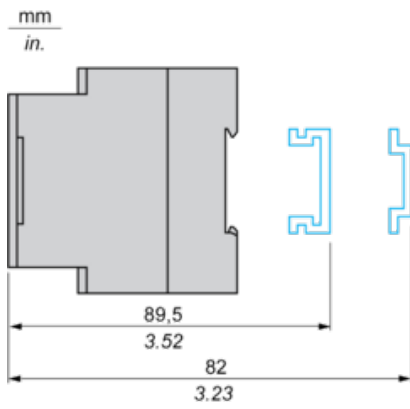

Screw fixing

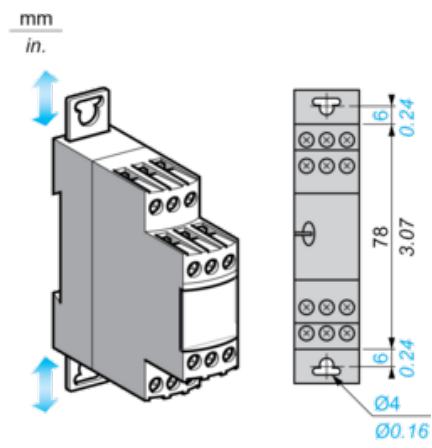

3-Phase Supply Control Relays

Wiring Diagram

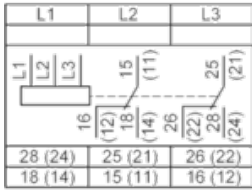

L1, L2, L3 Supply to be monitored

15(11)-18(14), 15(11)-16(12) 1st C/O contact of the output relay

25(21)-28(24), 25(21)-26(22) 2nd C/O contact of the output relay

Application Scheme

Example

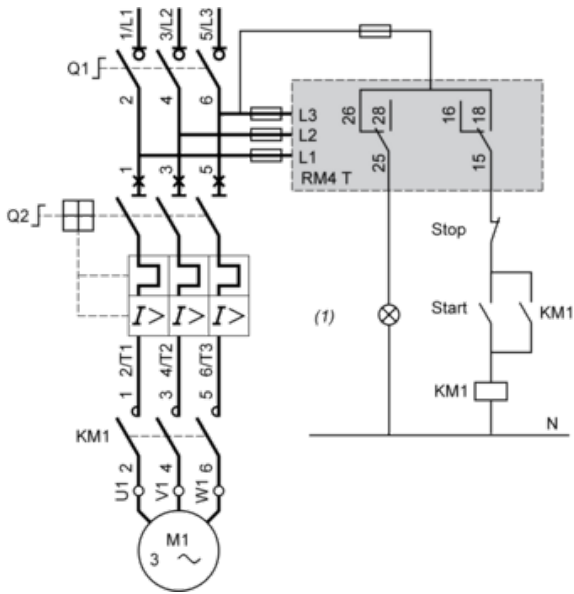

(1) Fault

Electrical Durability and Load Limit Curves

AC Load

Curve 1: Electrical durability of contacts on resistive load in millions of operating cycles

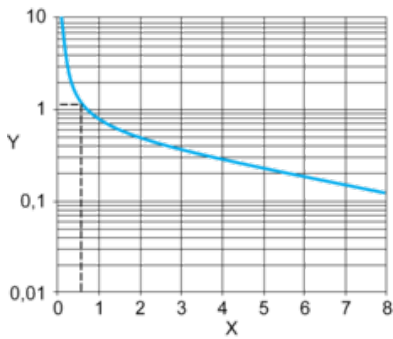

X Current broken in A

Y Millions of operating cycles

Curve 2: Reduction factor k for inductive loads (applies to values taken from durability Curve 1)

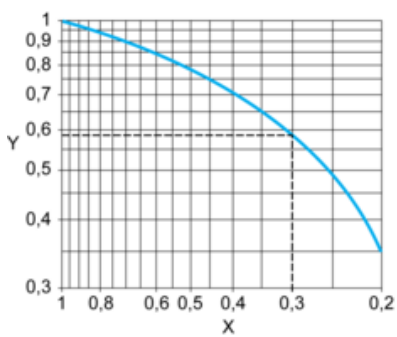

X Power factor on breaking (cos φ)

Y Reduction factor K

DC Load

Load limit curve

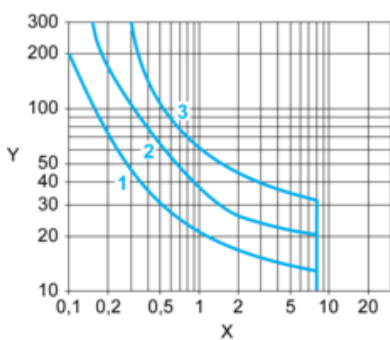

X Current in A

Y Voltage in V

1 L/R = 20 ms

2 L/R with load protection diode

3 Resistive load

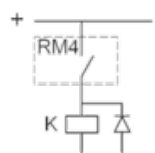

Function Diagram

Undervoltage Detection Only

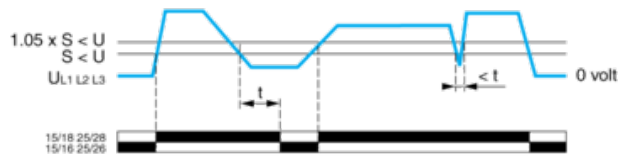

Legend

- t Fixed time delay = 550 ms
- U 3-phase supply voltage monitored
- S Overvoltage or undervoltage setting
- 15/18, 15/16; 25/28, 25/26 Output relays connections
- Relay status: black color = energized.

Recommended replacement(s)

RM4TU02 is replaced by:

1x



Modular 3 phase undervoltage control relay, Harmony, 8A, 2CO, 380...480V AC

RM22TU23
