

SACC-M12FS-4CON-PG7 - Connector



1681114

<https://www.phoenixcontact.com/in/products/1681114>

Please be informed that the data shown in this PDF document is generated from our Online Catalog. Please find the complete data in the user documentation. Our General Terms of Use for Downloads are valid.



Connector, Universal, 4-position, Socket straight M12, A, Screw connection, knurl material: Plastic, cable gland Pg7, external cable diameter 4 mm ... 6 mm

Your advantages

- Safe use in the field, thanks to a high degree of protection
- Screw connection: proven connection technology for a large selection of different conductors

Commercial Data

Item number	1681114
Packing unit	1 pc
Minimum order quantity	1 pc
Sales Key	BF2
Product Key	BF2CAA
Catalog Page	Page 22 (C-2-2019)
GTIN	4017918157463
Weight per Piece (including packing)	14.9 g
Weight per Piece (excluding packing)	14.3 g
Customs tariff number	85366990
Country of origin	DE

SACC-M12FS-4CON-PG7 - Connector



1681114

<https://www.phoenixcontact.com/in/products/1681114>

Technical Data

Notes

Assembly instruction:

NOTE: Observe the permissible bending radii when laying conductors, since the degree of protection may be put in jeopardy if the bending forces are too high. Alleviate mechanical loads upstream of the connector, e.g. by using cable ties.

Product properties

Product type	Circular connector (cable-side)
Number of positions	4
No. of cable outlets	1
Shielded	no
Coding	A
Cable outlet	straight
Pg screw connection	Pg7

Insulation characteristics

Overvoltage category	II
Degree of pollution	3

Dimensions

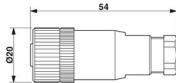
Dimensional drawing	
Length	54 mm

External dimensions

Outside diameter	4 mm ... 6 mm
------------------	---------------

Housing

Diameter housing	20 mm
------------------	-------

Material specifications

Color Handle area	black
Flammability rating according to UL 94	HB
Seal material	NBR
Material of grip body	PA
Contact material	CuZn
Contact surface material	CuSnZn
Contact carrier material	PA
Material for screw connection	Plastic

SACC-M12FS-4CON-PG7 - Connector



1681114

<https://www.phoenixcontact.com/in/products/1681114>

Connection data

Conductor connection

Connection method	Screw connection
Connection cross section	0.25 mm ² ... 0.75 mm ² (without ferrule)
	0.14 mm ² ... 0.75 mm ² (with ferrule)
	0.25 mm ² ... 0.75 mm ² (solid)
Connection cross section AWG	24 ... 18 (without ferrule)
	26 ... 20 (with ferrule)
Stripping length of the individual wire	5 mm
Tightening torque	0.4 Nm (M12 knurl)
	0.2 Nm (Screw terminal blocks)
	0.8 Nm ... 1 Nm (Pressure screw with sleeve housing)

Electrical properties

Rated surge voltage	2.5 kV
Contact resistance	≤ 8 mΩ
Insulation resistance	≥ 100 MΩ
Nominal voltage U _N	250 V AC
	250 V DC
Nominal current I _N	4 A

Mechanical properties

Mechanical data

Insertion/withdrawal cycles	≥ 50
-----------------------------	------

Connector

Connection 1

Head design	Socket
Head cable outlet	straight
Head thread type	M12
Coding	A

Cable/line

Signal type/category	Universal
Stripping length of the individual wire	5 mm

Environmental and real-life conditions

Ambient conditions

Degree of protection	IP67
Ambient temperature (operation)	-40 °C ... 85 °C (Plug / socket)

Standards and regulations

SACC-M12FS-4CON-PG7 - Connector



1681114

<https://www.phoenixcontact.com/in/products/1681114>

Standards/specifications

IEC 61076-2-101

SACC-M12FS-4CON-PG7 - Connector

1681114

<https://www.phoenixcontact.com/in/products/1681114>

Drawings

Dimensional drawing

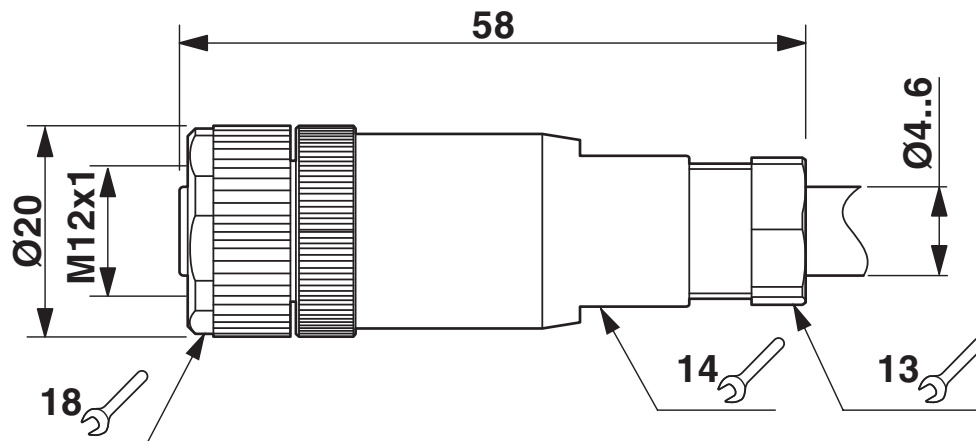

M12 x 1 socket, straight

Dimensional drawing

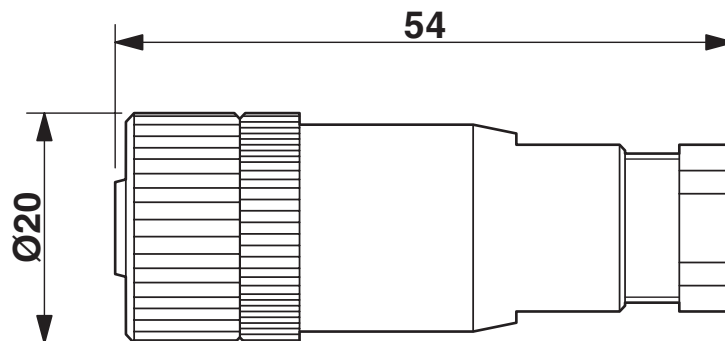

M12 x 1 socket, straight

1681114

<https://www.phoenixcontact.com/in/products/1681114>

Schematic diagram

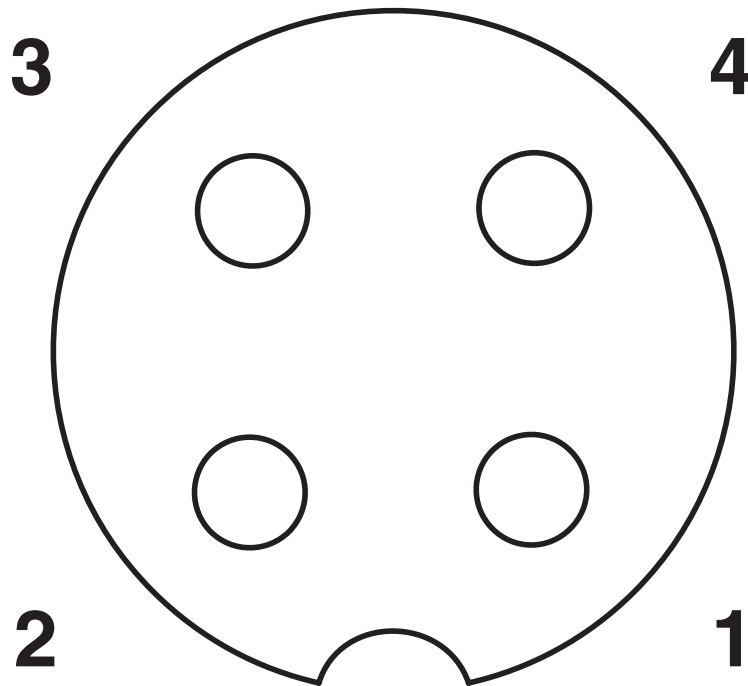

Pin assignment M12 socket, 4-pos., A-coded, view female side

Schematic diagram

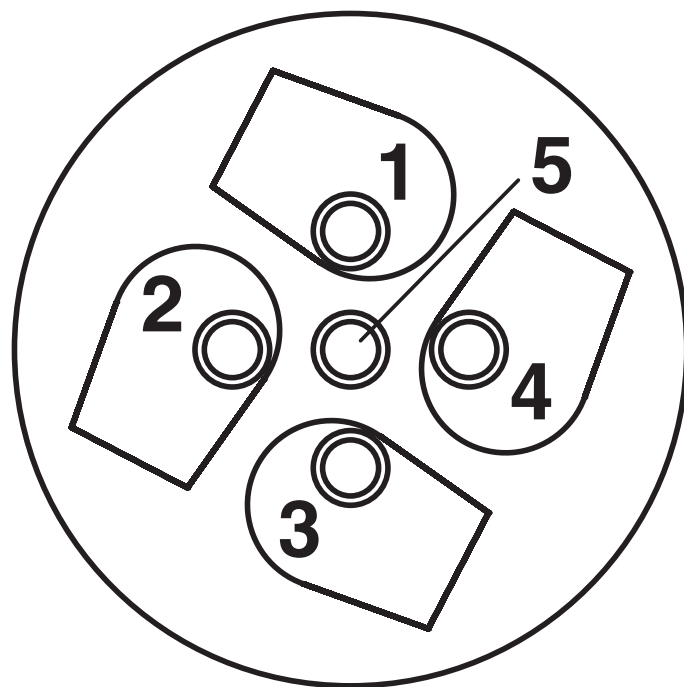

Cable connection side M12 (screw connection)

SACC-M12FS-4CON-PG7 - Connector

1681114

<https://www.phoenixcontact.com/in/products/1681114>

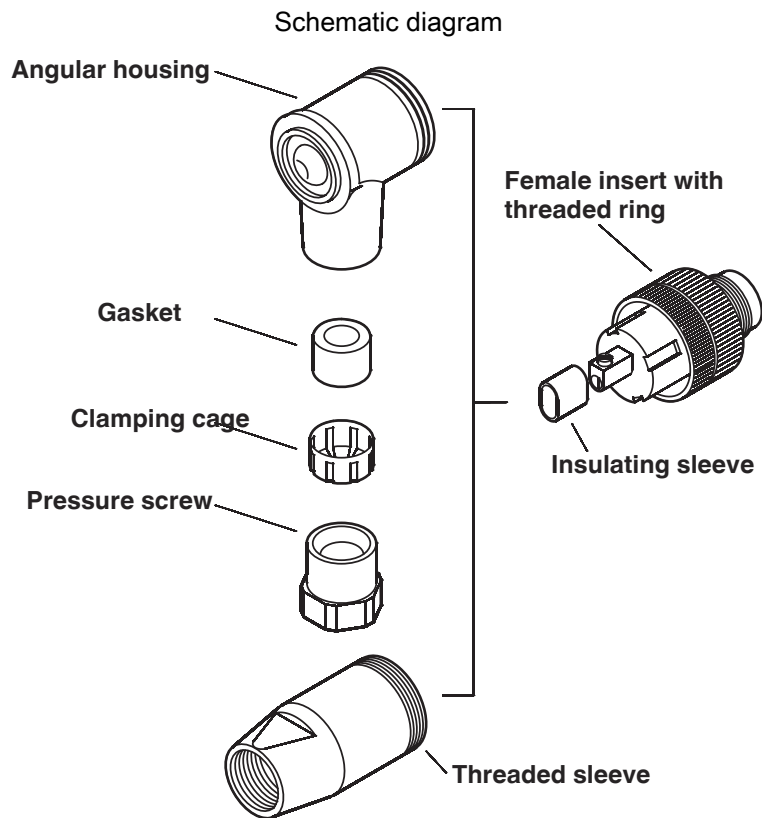

Male/Female M12

SACC-M12FS-4CON-PG7 - Connector



1681114

<https://www.phoenixcontact.com/in/products/1681114>

Approvals

 cUL Recognized Approval ID: FILE E 221474				
	Nominal Voltage U_N	Nominal Current I_N	Cross Section AWG	Cross Section mm^2
	250 V	4 A	-	-

 UL Recognized Approval ID: FILE E 221474				
	Nominal Voltage U_N	Nominal Current I_N	Cross Section AWG	Cross Section mm^2
	250 V	4 A	-	-

 EAC Approval ID: RU C-DE.BL08.B.00511				
-----------------------------------------------------------------------------------------------------------------------------------	--	--	--	--

SACC-M12FS-4CON-PG7 - Connector



1681114

<https://www.phoenixcontact.com/in/products/1681114>

Classifications

ECLASS

ECLASS-11.0	27440102
ECLASS-12.0	27440116
ECLASS-13.0	27440116

ETIM

ETIM 8.0	EC002635
----------	----------

UNSPSC

UNSPSC 21.0	39121400
-------------	----------

SACC-M12FS-4CON-PG7 - Connector



1681114

<https://www.phoenixcontact.com/in/products/1681114>

Environmental Product Compliance

REACH SVHC	Lead 7439-92-1
China RoHS	Environmentally Friendly Use Period = 50 years
	For information on hazardous substances, refer to the manufacturer's declaration available under "Downloads"

SACC-M12FS-4CON-PG7 - Connector

1681114

<https://www.phoenixcontact.com/in/products/1681114>



Accessories

SACC-M12-SET/2,5-3,5 - Connector

1436505

<https://www.phoenixcontact.com/in/products/1436505>



Sensor/actuator connector, accessories, pressure screw and Pg7 seal, for unshielded M12 connector, cable diameter 2.5 mm - 3.5 mm

TSD 04 SAC - Torque screwdriver

1208429

<https://www.phoenixcontact.com/in/products/1208429>



Torque screwdriver, with preset torque of 0.4 Nm and 4 mm hexagonal drive for M12 connectors

SACC-M12FS-4CON-PG7 - Connector



1681114

<https://www.phoenixcontact.com/in/products/1681114>

TSD-M 1,2NM - Torque screwdriver

1212224

<https://www.phoenixcontact.com/in/products/1212224>



Torque screw driver, accuracy as per EN ISO 6789 standard, adjustable from 0.3 - 1.2 Nm

TSD-M SAC-BIT ADAPTER - Adapter insert

1212600

<https://www.phoenixcontact.com/in/products/1212600>



Adapter bit for TSD-M...torque tools, E6.3-1/4" drive with 4 mm hexagon to accommodate SAC bits

SACC-M12FS-4CON-PG7 - Connector

1681114

<https://www.phoenixcontact.com/in/products/1681114>



SACC BIT M12-D20 - Tool

1208445

<https://www.phoenixcontact.com/in/products/1208445>

Nut for assembling M12 connectors for assembly with a knurl diameter of 20 mm, for 4 mm hexagonal drive



PROT-M12 MS-PA-CHAIN - Screw plug

1430899

<https://www.phoenixcontact.com/in/products/1430899>

M12 sealing cap with fixing band, for sensor cables, for free M12 sockets



SACC-M12FS-4CON-PG7 - Connector

1681114

<https://www.phoenixcontact.com/in/products/1681114>

SAC-4P-100,0-PUR/0,25 - Cable reel

1501692

<https://www.phoenixcontact.com/in/products/1501692>



By the meter, Cable reel, PUR halogen-free, black-gray RAL 7021, 4-wire, color single wire: brown, white, blue, black, cable length: 100 m

SAC-4P-100,0-PUR/0,34 - Cable reel

1501663

<https://www.phoenixcontact.com/in/products/1501663>



By the meter, Cable reel, PUR halogen-free, black-gray RAL 7021, 4-wire, color single wire: brown, white, blue, black, cable length: 100 m

SACC-M12FS-4CON-PG7 - Connector



1681114

<https://www.phoenixcontact.com/in/products/1681114>

SAC-4P-100,0-186/0,75 - Cable reel

1457461

<https://www.phoenixcontact.com/in/products/1457461>



By the meter, Cable reel, PUR, black-gray RAL 7021, 4-wire, color single wire: brown, white, blue, black, cable length: 100 m

A 0,25- 5 - Ferrule

3202465

<https://www.phoenixcontact.com/in/products/3202465>



Ferrule, length: 5 mm, color: silver

SACC-M12FS-4CON-PG7 - Connector



1681114

<https://www.phoenixcontact.com/in/products/1681114>

CRIMPFOX 6H - Crimping pliers

1212046

<https://www.phoenixcontact.com/in/products/1212046>



Crimping pliers, for ferrules without insulating collar according to DIN 46228 Part 1 and ferrules with insulating collar according to DIN 46228 Part 4, 0.14 mm² ... 6 mm², unlockable pressure lock, lateral entry

SZF 1-0,6X3,5 - Screwdriver

1204517

<https://www.phoenixcontact.com/in/products/1204517>



Actuation tool, for ST terminal blocks, also suitable for use as a bladed screwdriver, size: 0.6 x 3.5 x 100 mm, 2-component grip, with non-slip grip

Phoenix Contact 2023 © - all rights reserved
<https://www.phoenixcontact.com>

PHOENIX CONTACT (I) Pvt. Ltd.
A-58/2, Okhla Industrial Area, Phase - II, New Delhi-110 020

+91.1275.71420
info@phoenixcontact.co.in