

25.4 mm SQUARE FLANGE, STRAIGHT JACKS, FOR SEMI RIGID CABLES (25.4 mm = 1 inch)

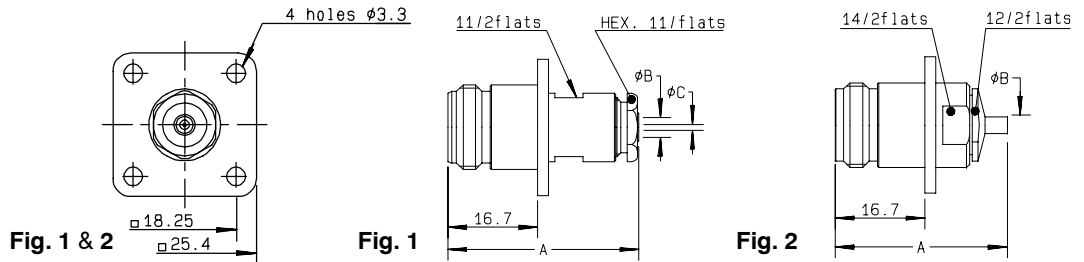

cable group	part number	fig.	dimensions (mm)			captured center contact	mounting	panel	note
			A	B	C				
.085"	R161 276 300	2	32	2.25		NO	M21	P01	Solder type
.141"	R161 277 000	1	35.5	5.6	3.65	NO	M06	P01	Clamp type
.141"	R161 277 020●	1	35.5	5.6	3.65	YES	M06	P01	Clamp type
.141"	R161 277 300	2	32	3.65		NO	M21	P01	Solder type
.250"	R161 278 300	2	32	6.6		NO	M21	P01	Solder type

BULKHEAD STRAIGHT JACKS, FULL CRIMP TYPE, FOR FLEXIBLE CABLES (PANEL SEALED) (single piece body)

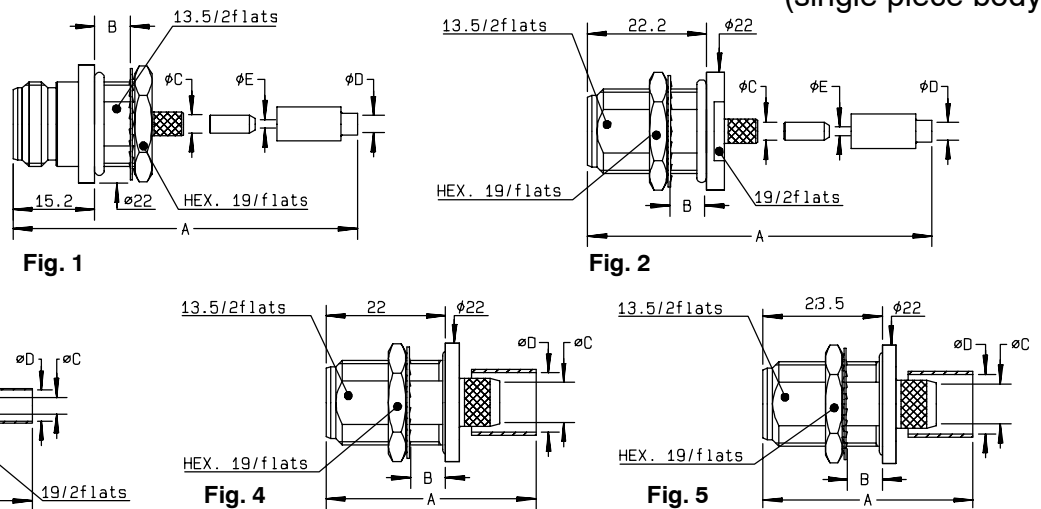

cable group	part number	fig.	dimensions (mm)					captured center contact	mounting	panel	note
			A	B	C	D	E				
2 / 50 / S + D	R161 309 000	1	40.4	6.5	3.38	2.35	1	YES	M09	P10	Front mount
2 / 50 / S + D	R161 309 200	2						YES	M09	P10	Rear mount
2.6 / 50 / S + D	R161 311 200	1	40.4	6.5	3.38	3.25	1.63	YES	M09	P10	Front mount
2.6 / 50 / S + D	R161 311 300	2						YES	M09	P10	Rear mount
5 / 50 / S	R161 329 130	3	39.8	6.5	3.11	5.41		YES	M12	P10	LMR 200 cable / Rear mount
5 / 50 / S	R161 329 000	3						YES	M12	P10	Rear mount
5 / 50 / D	R161 329 200	3						YES	M12	P10	Rear mount
10 / 50 / S	R161 331 000	4	40.6	6.5	7.46	11.05		YES	M10	P10	Rear mount
10.3 / 50 / S	R161 331 060	5	46.88	6.5	7.46	11.05		YES	M11	P10	LMR 400 cable / Rear mount
11 / 50 / D	R161 331 200	4	40.6	6.5	7.46	11.4		YES	M10	P10	Rear mount
15.2 / 50 / S	R161 331 400	5	49.9	6.5	11.96	15.88		YES	M11	P10	LMR 600 cable / Rear mount / Solder type center contact

● Upon request

Note : standard packaging = 50 pieces. For unit packaging, add "W" after the P/N.

BULKHEAD STRAIGHT JACKS, CLAMP TYPE, FOR FLEXIBLE CABLES (PANEL SEALED)

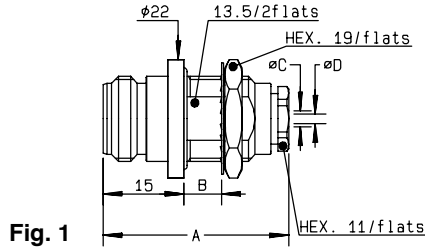

Fig. 1

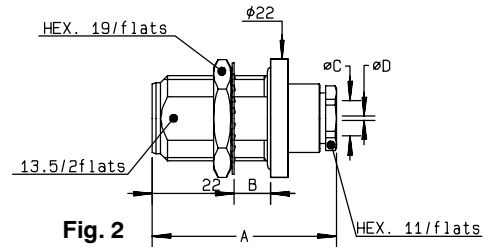

Fig. 2

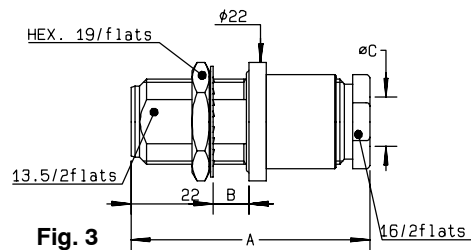

Fig. 3

cable group	part number	fig.	dimensions (mm)				captured center contact	mounting	panel	note
			A	B	C	D				
2.6 / 50 / S + D	R161 321 000	1	34.3	8	3.1	1.7	YES	M01	P10	Front mount
2.6 / 50 / S + D	R161 322 000	2	34.3	6.5	3.1	1.7	YES	M01	P10	Rear mount
5 / 50 / S + D	R161 325 000	2	35.4	6.5	5.6		YES	M01	P10	Rear mount
10 + 11 / 50 / S + D	R161 332 000	3	43	6.5	11.2		NO	M04	P10	Rear mount

BULKHEAD STRAIGHT JACKS, EZ FIT TYPE, FOR CORRUGATED CABLES

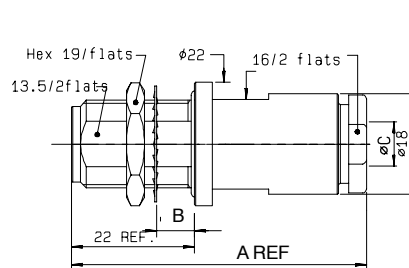

Fig. 1

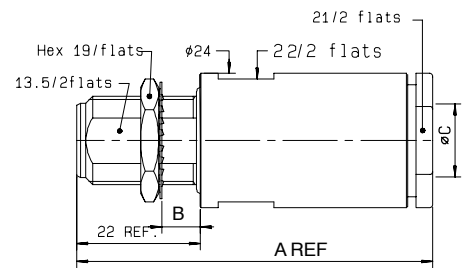
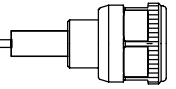

Fig. 2

cable group	part number	fig.	dimensions (mm)			captured center contact	mounting	panel
			A	B	C			
1/4" superflexible corrugated	R161 341 007	1	52.7	6.5	7.9	YES	M22	P10
3/8" superflexible corrugated	R161 341 207	2	66	6.5	11	YES	M22	P10
1/2" superflexible corrugated	R161 341 407	2	66	6.5	14	YES	M22	P10

Note : standard packaging = 50 pieces. For unit packaging, add "W" after the P/N.



BULKHEAD STRAIGHT JACKS, FOR SEMI RIGID CABLES (PANEL SEALED)

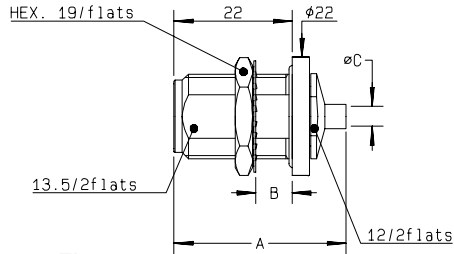

Fig. 1

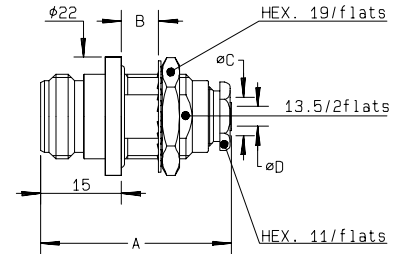

Fig. 2

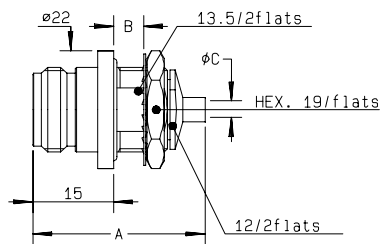

Fig. 3

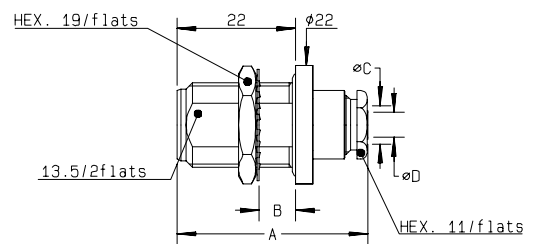

Fig. 4

cable group	part number	fig.	dimensions (mm)				captured center contact	mounting	panel	note
			A	B	C	D				
.085"	R161 335 200	1	32	6.5	2.25		NO	M21	P10	Solder type / Rear mount
.141"	R161 323 000	2	35.5	8	5.6	3.65	NO	M06	P10	Clamp type / Front mount
.141"	R161 323 020●	2	35.5	8	5.6	3.65	YES	M06	P10	Clamp type / Front mount
.141"	R161 323 200	4	35.5	6.5	5.6	3.65	YES	M06	P10	Clamp type / Rear mount
.141"	R161 336 000	1	32	6.5	3.65		NO	M21	P10	Solder type / Rear mount
.141"	R161 336 200	3	32	6.5	3.65		NO	M21	P10	Solder type / Front mount
.250"	R161 337 200	1	32	6.5	6.6		NO	M21	P10	Solder type / Rear mount

● Upon request

Note : standard packaging = 50 pieces. For unit packaging, add "W" after the P/N.