

# PC 5/ 2-ST1-7,62 - PCB connector



1777723

<https://www.phoenixcontact.com/in/products/1777723>

Please be informed that the data shown in this PDF document is generated from our Online Catalog. Please find the complete data in the user documentation. Our General Terms of Use for Downloads are valid.

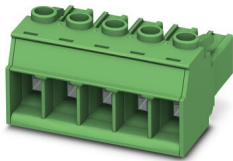

PCB connector, nominal cross section: 6 mm<sup>2</sup>, color: green, nominal current: 41 A, rated voltage (III/2): 1000 V, contact surface: Tin, type of contact: Socket, number of potentials: 2, number of rows: 1, number of positions: 2, number of connections: 2, product range: PC 5/...-ST1, pitch: 7.62 mm, connection method: Screw connection with tension sleeve, screw head form: H1L Philipps recess with slotted Torx, conductor/PCB connection direction: 0 °, locking clip: - Locking clip, plug-in system: COMBICON PC 5, locking: without, mounting: without, type of packaging: packed in cardboard

## Your advantages

- Well-known connection principle allows worldwide use
- Low temperature rise, thanks to maximum contact force
- Allows connection of two conductors
- Integrated double steel spring provides additional safety in the event of temperature and power fluctuations
- 600 V UL approval in the smallest of dimensions

## Commercial Data

Item number	1777723
Packing unit	50 pc
Minimum order quantity	50 pc
Sales Key	AAD
Product Key	AADABA
Catalog Page	Page 524 (C-1-2013)
GTIN	4046356522267
Weight per Piece (including packing)	9.29 g
Weight per Piece (excluding packing)	9.29 g
Customs tariff number	85366990
Country of origin	DE

1777723

<https://www.phoenixcontact.com/in/products/1777723>

## Technical Data

### Product properties

Type	Standard
Product line	COMBICON Connectors L
Product type	PCB plug
Product family	PC 5/...-ST1
Number of positions	2
Pitch	7.62 mm
Number of connections	2
Number of rows	1
Mounting flange	without
Number of potentials	2

### Electrical properties

Nominal current $I_N$	41 A
Nominal voltage $U_N$	1000 V
Degree of pollution	3
Contact resistance	0.4 mΩ
Rated voltage (III/3)	1000 V
Rated surge voltage (III/3)	8 kV
Rated voltage (III/2)	1000 V
Rated surge voltage (III/2)	8 kV
Rated voltage (II/2)	1000 V
Rated surge voltage (II/2)	6 kV

### Connection data

#### Connection technology

Type	Standard
Connector system	COMBICON PC 5
Nominal cross section	6 mm <sup>2</sup>
Type of contact	Socket

#### Interlock

Locking type	without
Mounting flange	without

#### Conductor connection

Connection method	Screw connection with tension sleeve
Conductor/PCB connection direction	0 °
Conductor cross section rigid	0.2 mm <sup>2</sup> ... 10 mm <sup>2</sup>
Conductor cross section flexible	0.2 mm <sup>2</sup> ... 6 mm <sup>2</sup>
Conductor cross section AWG	24 ... 10
Conductor cross section flexible, with ferrule without plastic	0.25 mm <sup>2</sup> ... 6 mm <sup>2</sup>

# PC 5/ 2-ST1-7,62 - PCB connector



1777723

<https://www.phoenixcontact.com/in/products/1777723>

sleeve	
Conductor cross section, flexible, with ferrule, with plastic sleeve	0.25 mm <sup>2</sup> ... 4 mm <sup>2</sup>
2 conductors with same cross section, solid	0.2 mm <sup>2</sup> ... 2.5 mm <sup>2</sup>
2 conductors with same cross section, flexible	0.2 mm <sup>2</sup> ... 4 mm <sup>2</sup>
2 conductors with same cross section, flexible, with ferrule without plastic sleeve	0.25 mm <sup>2</sup> ... 1.5 mm <sup>2</sup>
2 conductors with the same cross section, flexible, with TWIN ferrule with plastic sleeve	0.25 mm <sup>2</sup> ... 2.5 mm <sup>2</sup>
Cylindrical gauge a x b / diameter	3.6 mm x 3.1 mm / 3.4 mm
Stripping length	10 mm
Tightening torque	0.5 Nm ... 0.8 Nm ( $\leq 4 \text{ mm}^2$ is 0.5 Nm to 0.6 Nm, $> 4 \text{ mm}^2$ is 0.7 Nm to 0.8 Nm)

## Material specifications

### Material data - contact

Note	WEEE/RoHS-compliant, free of whiskers according to IEC 60068-2-82/JEDEC JESD 201
Contact material	Cu alloy
Surface characteristics	hot-dip tin-plated
Metal surface terminal point (top layer)	Tin (4 - 8 $\mu\text{m}$ Sn)
Metal surface contact area (top layer)	Tin (4 - 8 $\mu\text{m}$ Sn)

### Material data - housing

Color (Housing)	green (6021)
Insulating material	PA
Insulating material group	I
CTI according to IEC 60112	600
Flammability rating according to UL 94	V0
Glow wire flammability index GWFI according to EN 60695-2-12	850
Glow wire ignition temperature GWIT according to EN 60695-2-13	775
Temperature for the ball pressure test according to EN 60695-10-2	125 °C

### Material data – actuating element

Color ( )	( )
-----------	-----

## Dimensions

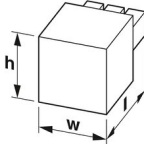
Dimensional drawing	
Pitch	7.62 mm
Width [w]	15.19 mm
Height [h]	19.7 mm

# PC 5/ 2-ST1-7,62 - PCB connector



1777723

<https://www.phoenixcontact.com/in/products/1777723>

Length [l]	35.25 mm
------------	----------

## Mounting

Drive form screw head	Philipps recess with slotted Torx (H1L)
Drive form screw head	Philipps recess with slotted Torx (H1L)

## Notes

Notes on operation	In accordance with IEC 61984, COMBICON connectors have no switching power (COC). During designated use, they must not be plugged in or disconnected when carrying voltage or under load.
--------------------	--

## Mechanical tests

### Test for conductor damage and slackening

Specification	IEC 60999-1:1999-11
Result	Test passed

### Pull-out test

Specification	IEC 60999-1:1999-11
Conductor cross section/conductor type/tractive force setpoint/actual value	0.2 mm <sup>2</sup> / solid / > 10 N
	0.2 mm <sup>2</sup> / flexible / > 10 N
	6 mm <sup>2</sup> / solid / > 80 N
	4 mm <sup>2</sup> / flexible / > 60 N
	6 mm <sup>2</sup> / flexible / > 80 N
10 mm <sup>2</sup> / solid / > 90 N	

### Insertion and withdrawal forces

Result	Test passed
No. of cycles	50
Insertion strength per pos. approx.	8 N
Withdraw strength per pos. approx.	4 N

### Torque test

Specification	IEC 60999-1:1999-11
---------------	---------------------

### Contact holder in insert

Specification	IEC 60512-15-1:2008-05
Contact holder in insert Requirements >20 N	Test passed

### Resistance of inscriptions

Specification	IEC 60068-2-70:1995-12
Result	Test passed

### Polarization and coding

Specification	IEC 60512-13-5:2006-02
Result	Test passed

### Visual inspection

# PC 5/ 2-ST1-7,62 - PCB connector



1777723

<https://www.phoenixcontact.com/in/products/1777723>

Specification	IEC 60512-1-1:2002-02
Result	Test passed

## Dimension check

Specification	IEC 60512-1-2:2002-02
Result	Test passed

## Environmental and real-life conditions

### Vibration test

Specification	IEC 60068-2-6:2007-12
Frequency	10 - 150 - 10 Hz
Sweep speed	1 octave/min
Amplitude	0.35 mm (10 Hz ... 60.1 Hz)
Sweep speed	5g (60.1 Hz ... 150 Hz)
Test duration per axis	2.5 h

### Durability test

Specification	IEC 60512-9-1:2010-03
Impulse withstand voltage at sea level	7.3 kV
Contact resistance $R_1$	0.4 m $\Omega$
Contact resistance $R_2$	0.4 m $\Omega$
Insertion/withdrawal cycles	50
Insulation resistance, neighboring positions	> 5 M $\Omega$

### Climatic test

Specification	ISO 6988:1985-02
Corrosive stress	0.2 dm <sup>3</sup> SO <sub>2</sub> on 300 dm <sup>3</sup> /40 °C/1 cycle
Thermal stress	100 °C/168 h
Power-frequency withstand voltage	3.31 kV

### Ambient conditions

Ambient temperature (operation)	-40 °C ... 100 °C (dependent on the derating curve)
Ambient temperature (storage/transport)	-40 °C ... 70 °C
Relative humidity (storage/transport)	30 % ... 70 %
Ambient temperature (assembly)	-5 °C ... 100 °C

## Electrical tests

### Thermal test | Test group C

Specification	IEC 60512-5-1:2002-02
Tested number of positions	12

### Insulation resistance

Specification	IEC 60512-3-1:2002-02
Insulation resistance, neighboring positions	> 5 M $\Omega$

### Air clearances and creepage distances |

# PC 5/ 2-ST1-7,62 - PCB connector



1777723

<https://www.phoenixcontact.com/in/products/1777723>

Specification	IEC 60664-1:2007-04
Insulating material group	I
Comparative tracking index (IEC 60112)	CTI 600
Rated insulation voltage (III/3)	1000 V
Rated surge voltage (III/3)	8 kV
minimum clearance value - non-homogenous field (III/3)	8 mm
minimum creepage distance (III/3)	12.5 mm
Rated insulation voltage (III/2)	1000 V
Rated surge voltage (III/2)	8 kV
minimum clearance value - non-homogenous field (III/2)	8 mm
minimum creepage distance (III/2)	8 mm
Rated insulation voltage (II/2)	1000 V
Rated surge voltage (II/2)	6 kV
minimum clearance value - non-homogenous field (II/2)	5.5 mm
minimum creepage distance (II/2)	5.5 mm

## Packaging specifications

Type of packaging	packed in cardboard
-------------------	---------------------

Drawings

Diagram

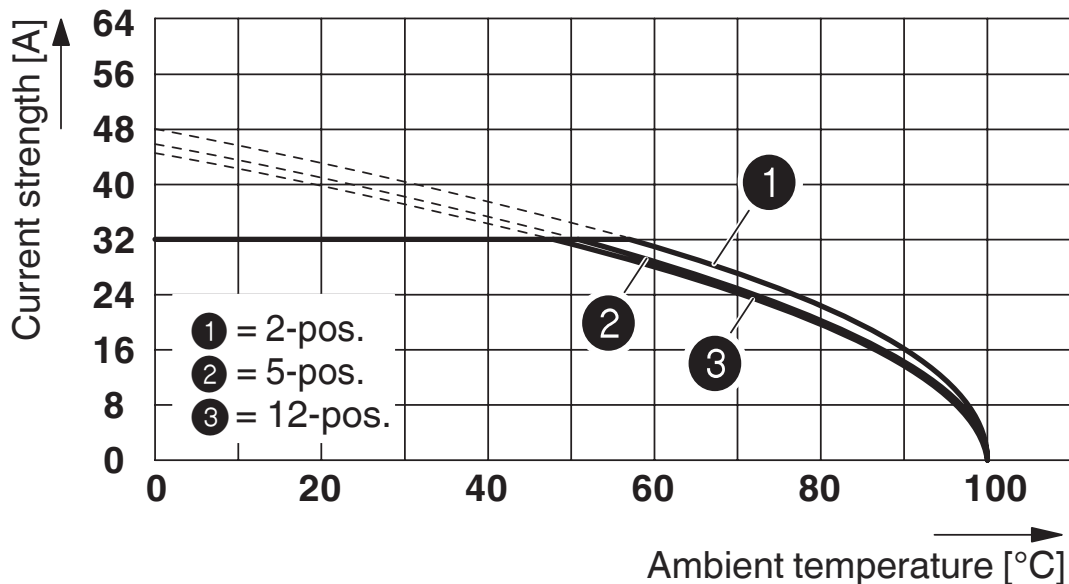

Derating curve for: PC 5/...-ST1-7,62 with PCV 5/....-G-7,62  
 Conductor cross section: 6 mm<sup>2</sup>

Diagram

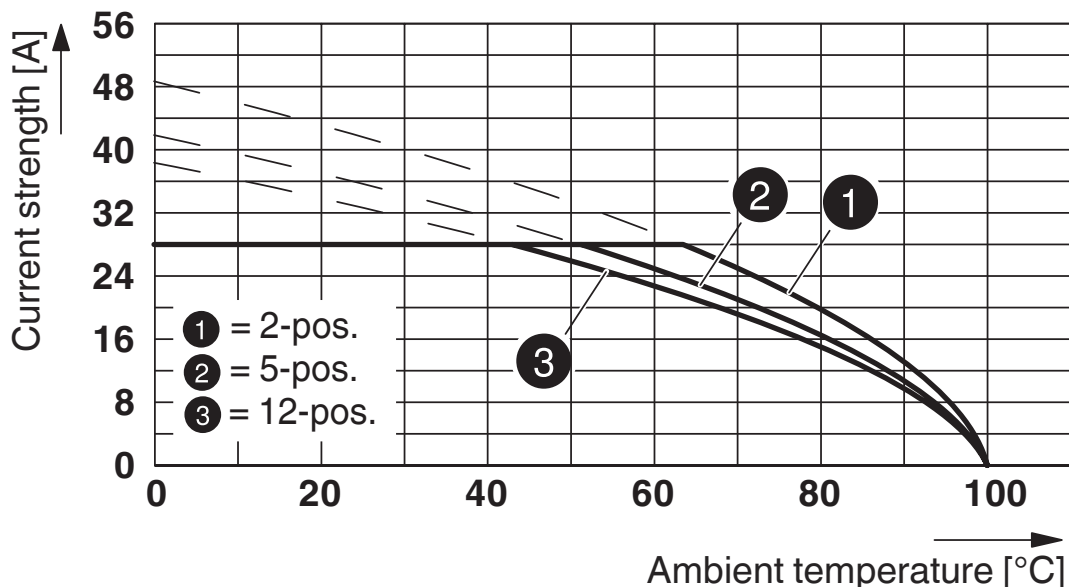

Derating curve for: PC 5/...-ST1-7,62 with PC 4/....-G-7,62  
 Conductor cross section: 4 mm<sup>2</sup>

# PC 5/ 2-ST1-7,62 - PCB connector

177723

<https://www.phoenixcontact.com/in/products/177723>

Dimensional drawing

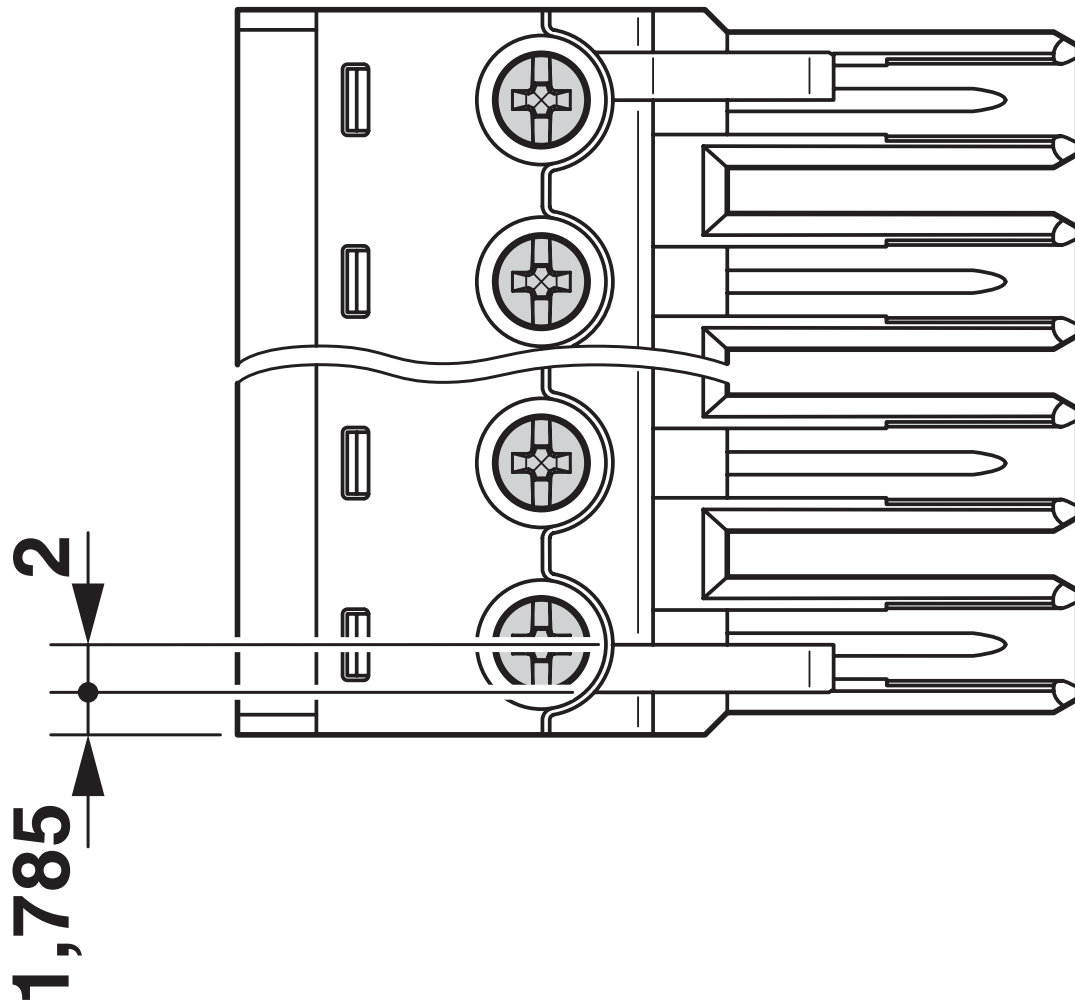



1777723

<https://www.phoenixcontact.com/in/products/1777723>

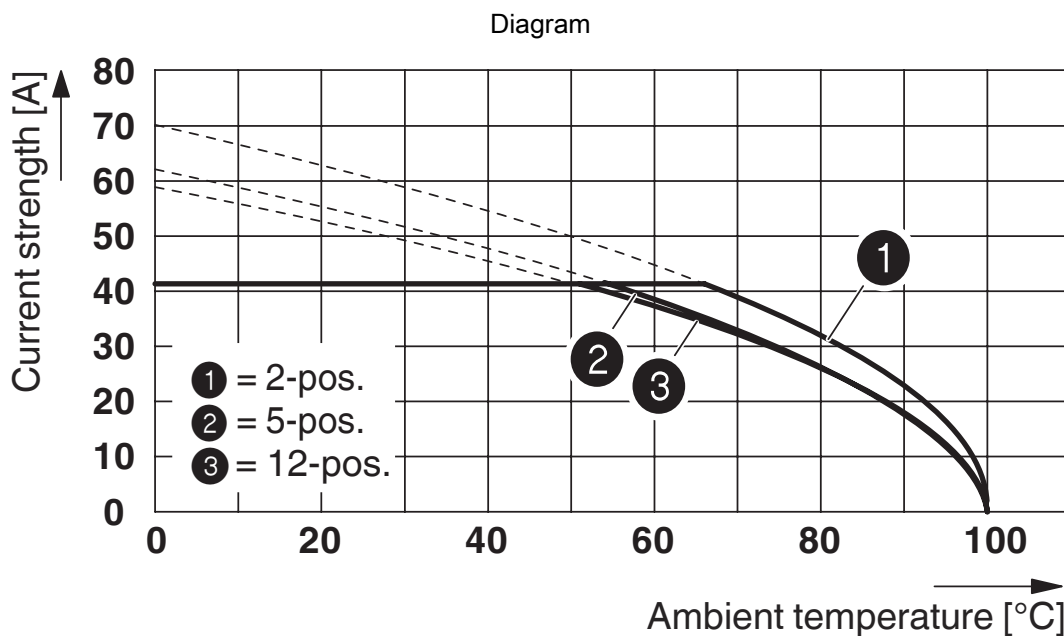

Derating curve for: PC 5/...-ST1-7,62 with PCV 5/...-G-7,62  
 Conductor cross section: 10 mm<sup>2</sup>

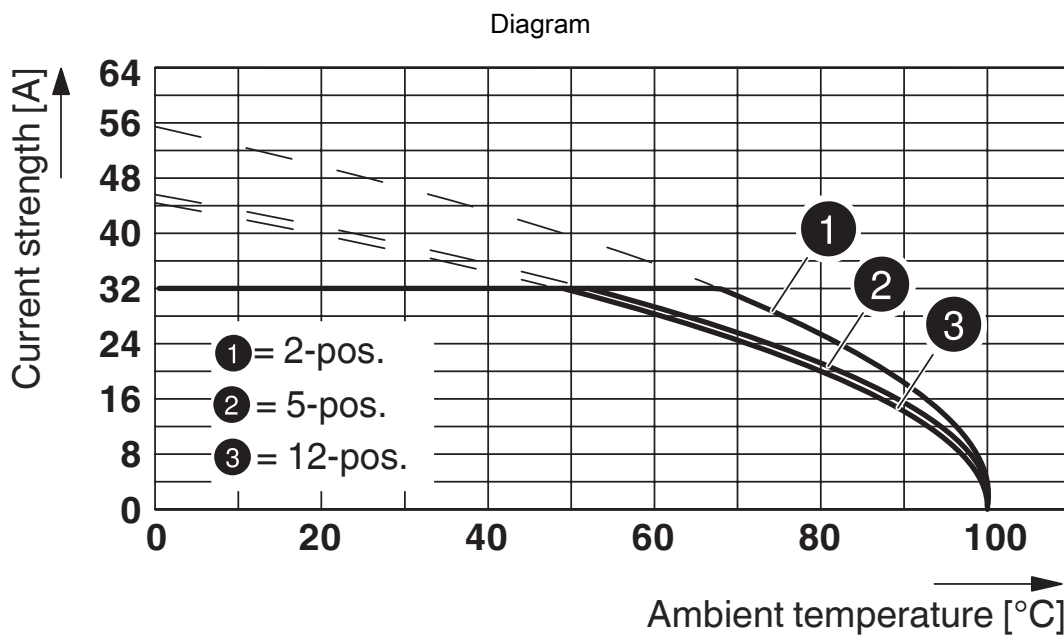

Derating curve for: PC 5/...-ST1-7,62 with PCV 4/...-G-7,62  
 Conductor cross section: 6 mm<sup>2</sup>

# PC 5/ 2-ST1-7,62 - PCB connector



1777723

<https://www.phoenixcontact.com/in/products/1777723>

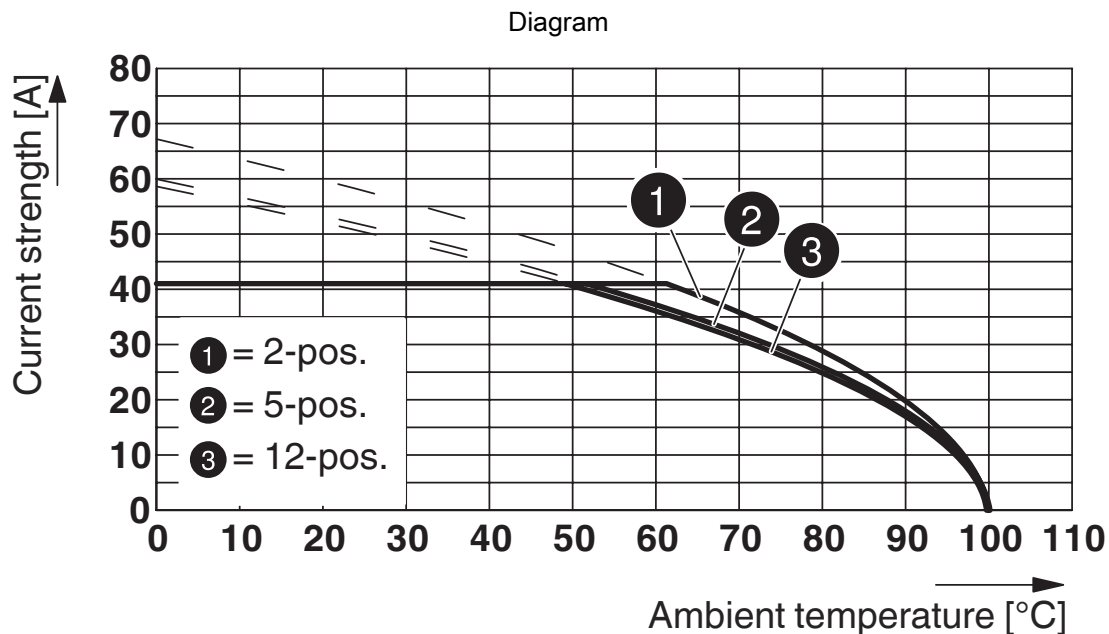

Type: PC 5/...-ST(F)1-7,62 with PC 5/...-G(F)U-7,62

Conductor cross section: 10 mm<sup>2</sup>

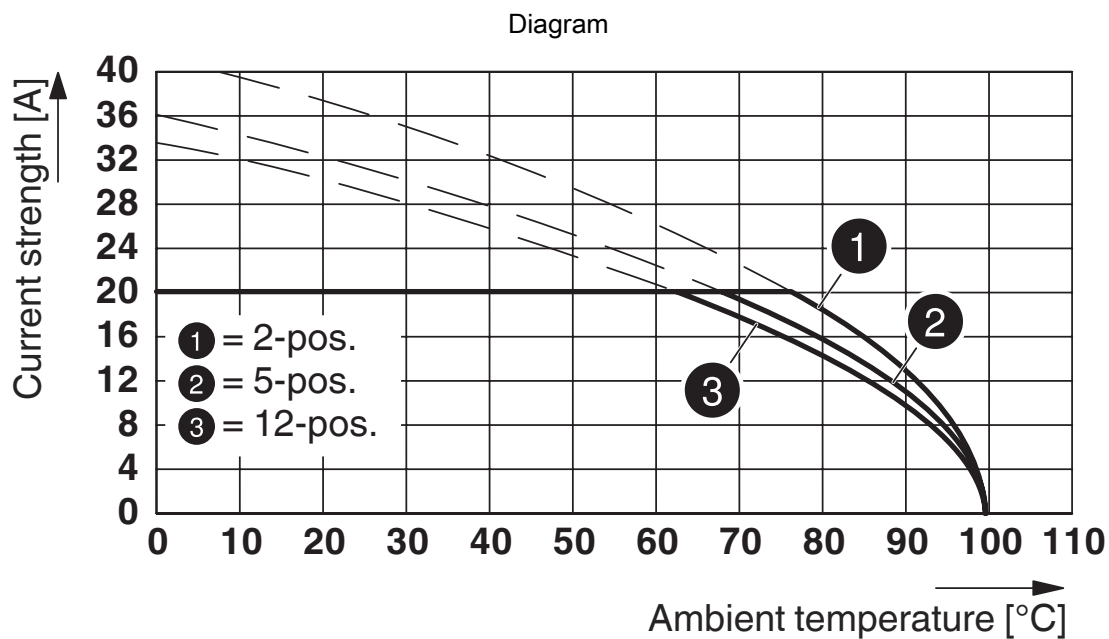

Type: PC 5/...-ST1-7,62 with PCVK 4-7,62

# PC 5/ 2-ST1-7,62 - PCB connector

1777723

<https://www.phoenixcontact.com/in/products/1777723>

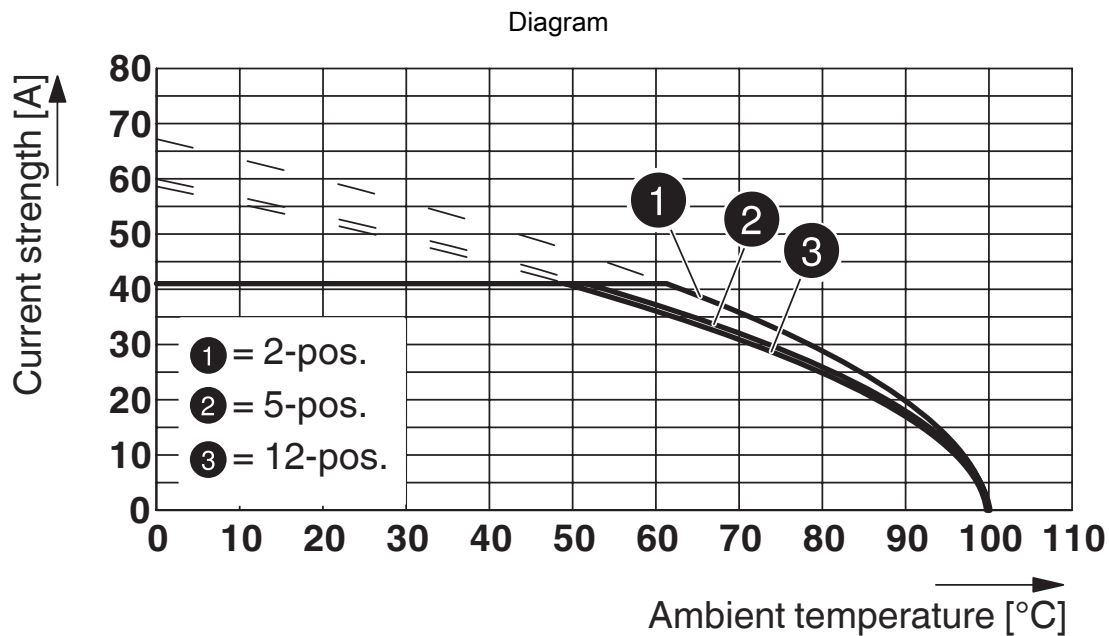

Type: PC 5/...-ST1-7,62 with PC 5/...-GU-7,62 P26 THT R..  
Conductor cross section: 10 mm<sup>2</sup>

## Dimensional drawing

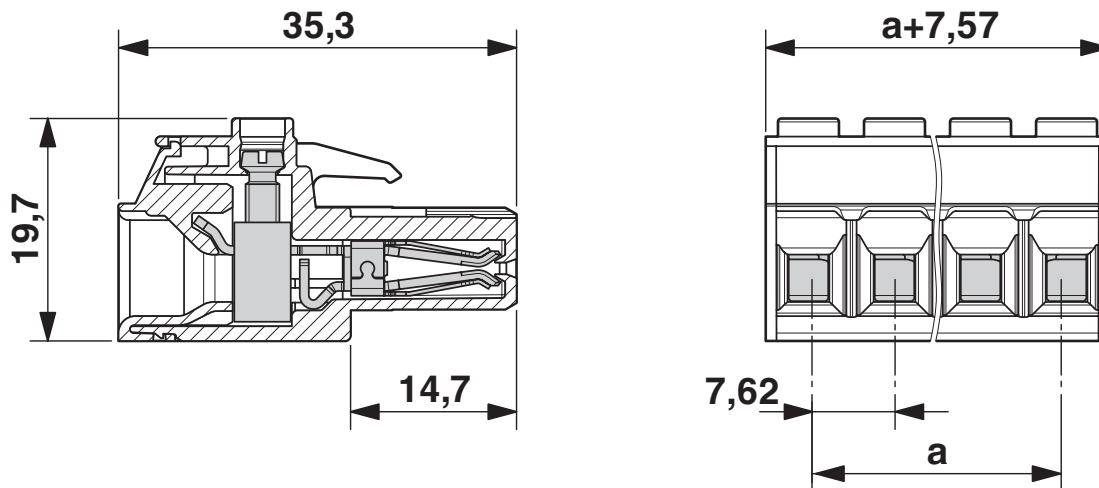

# PC 5/ 2-ST1-7,62 - PCB connector



1777723

<https://www.phoenixcontact.com/in/products/1777723>

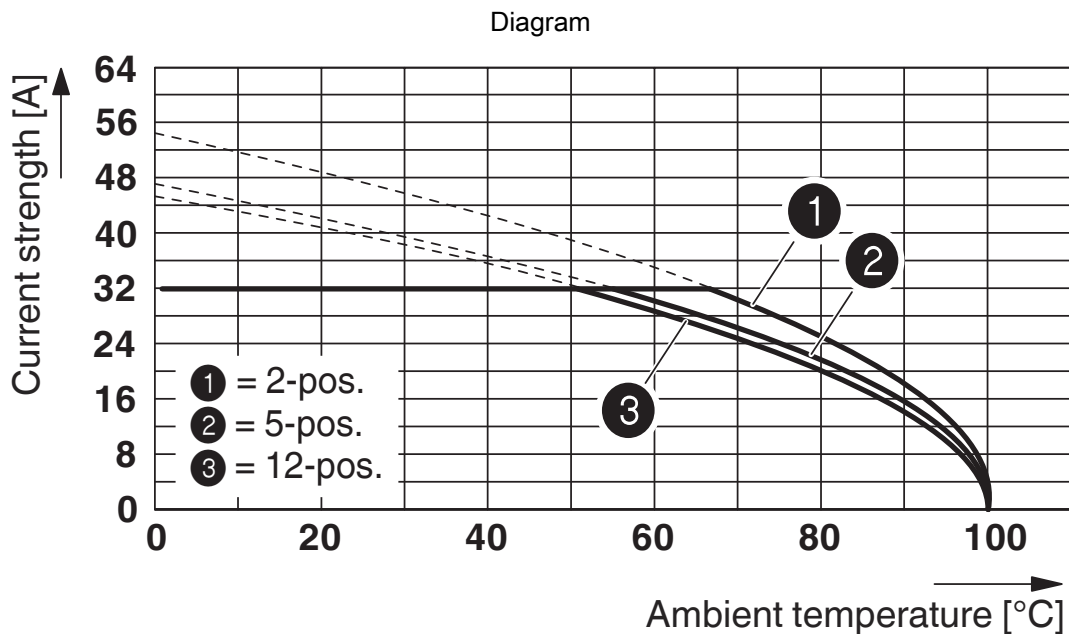

Derating curve for: PC 5/...-ST1-7,62 with PC 5/...-G-7,62  
 Conductor cross section: 6 mm<sup>2</sup>

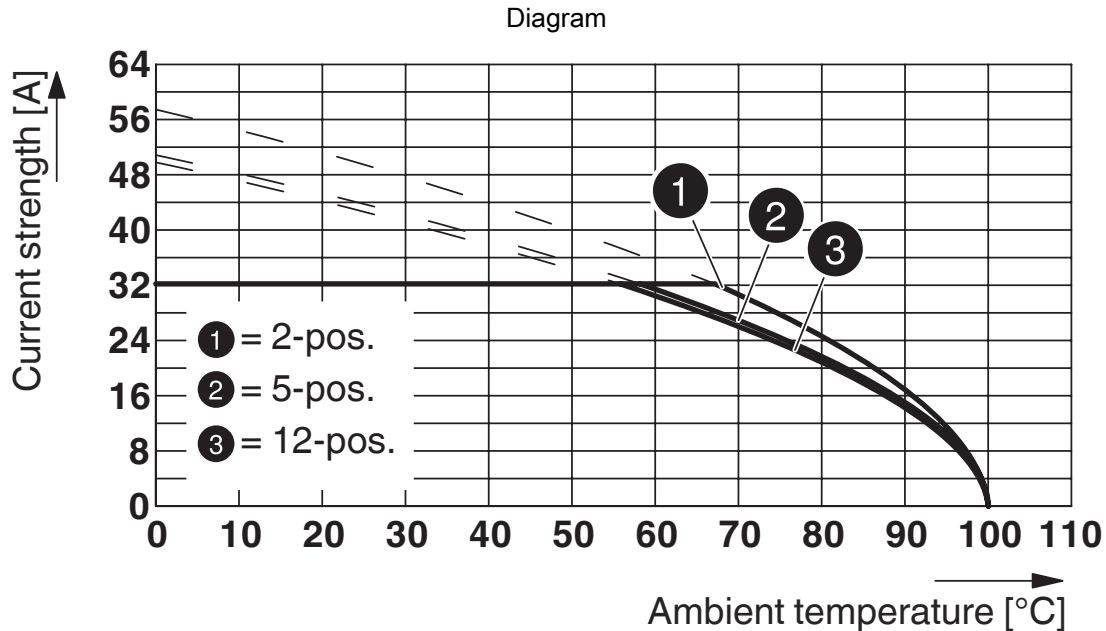

Type: PC 5/...-ST(F)1-7,62 with PC 5/...-GU(F)-7,62  
 Conductor cross section: 6 mm<sup>2</sup>

# PC 5/ 2-ST1-7,62 - PCB connector



1777723

<https://www.phoenixcontact.com/in/products/1777723>

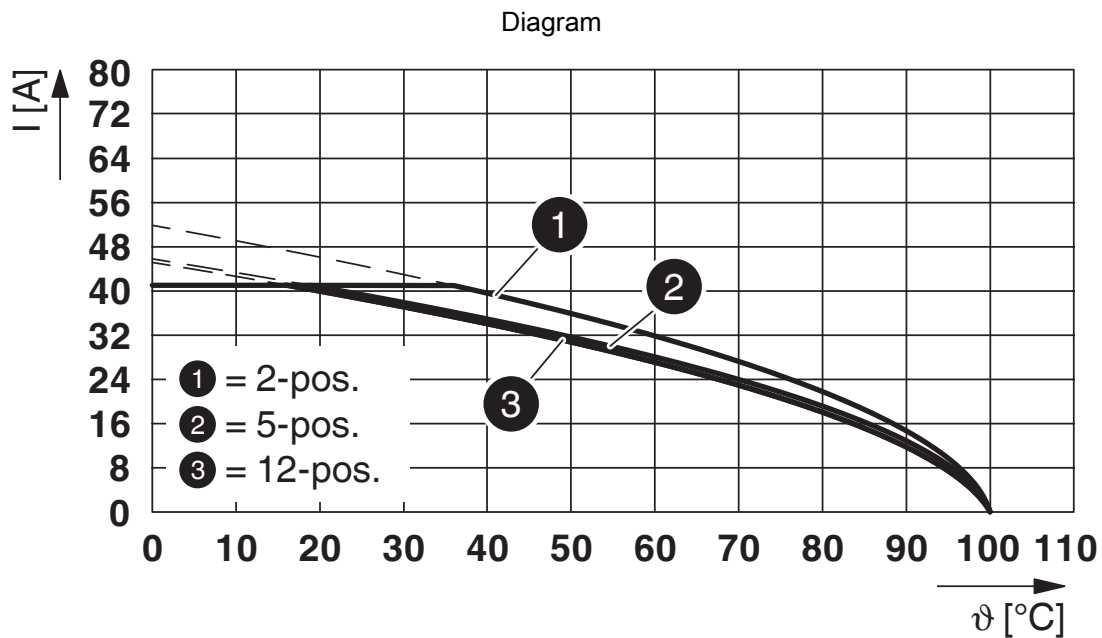

Type: PC 5/...-ST1-7,62 with IPC 5/...-ST-7,62

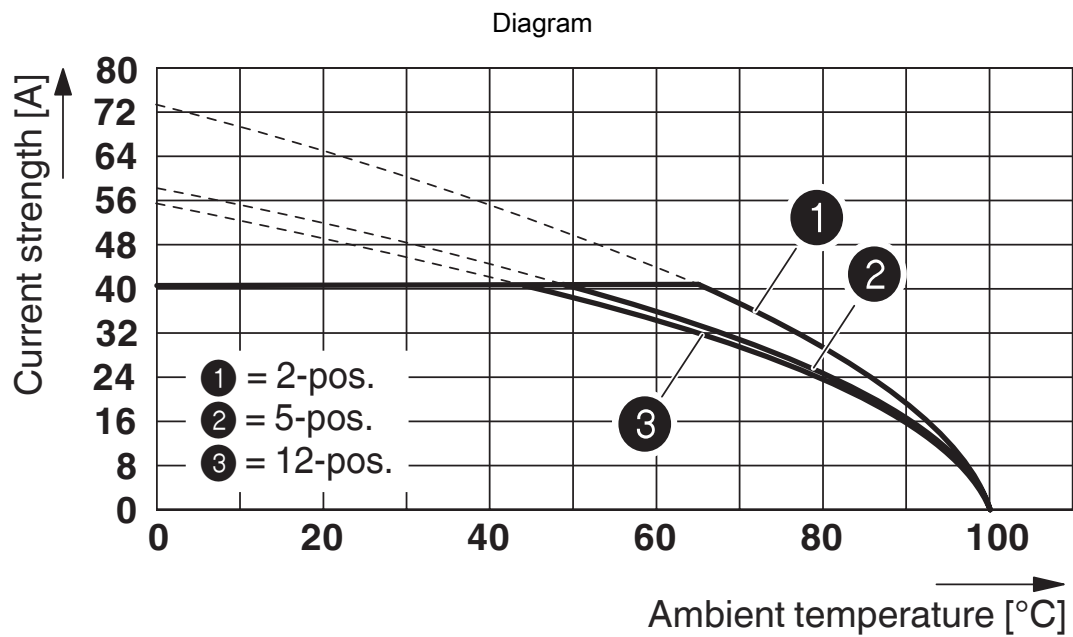

Derating curve for: PC 5/...-ST1-7,62 with PC 5/...-G-7,62  
 Conductor cross section: 10 mm<sup>2</sup>

# PC 5/ 2-ST1-7,62 - PCB connector



1777723

<https://www.phoenixcontact.com/in/products/1777723>

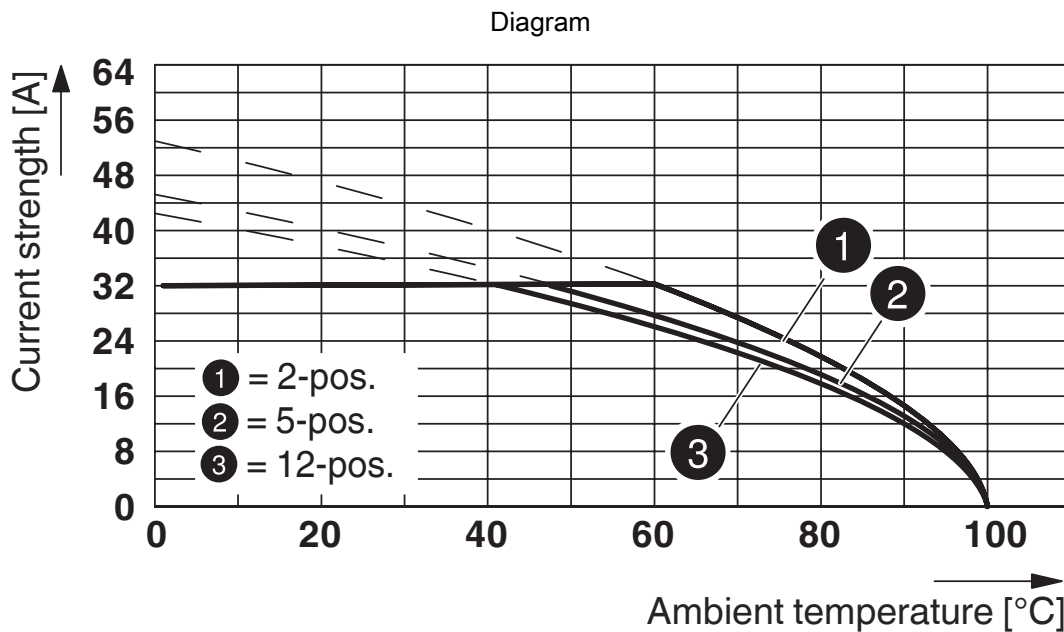

Derating curve for: PC 5/...-ST1-7,62 with PC 4/...-G-7,62  
Conductor cross section: 6 mm<sup>2</sup>

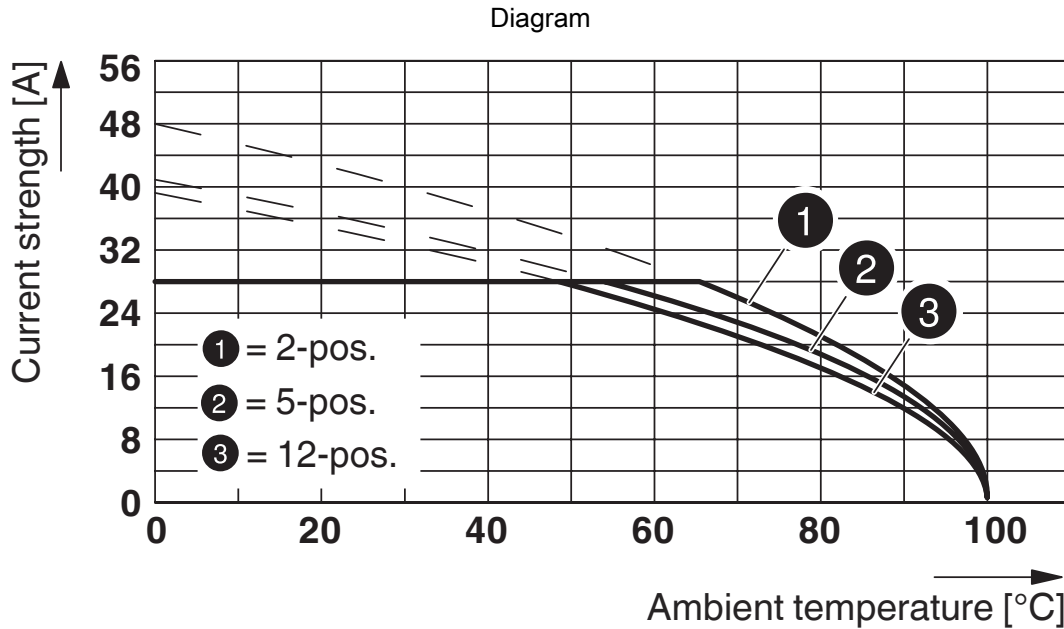

Derating curve for: PC 5/...-ST1-7,62 with PCV 4/...-G-7,62  
Conductor cross section: 4 mm<sup>2</sup>

# PC 5/ 2-ST1-7,62 - PCB connector



1777723

<https://www.phoenixcontact.com/in/products/1777723>

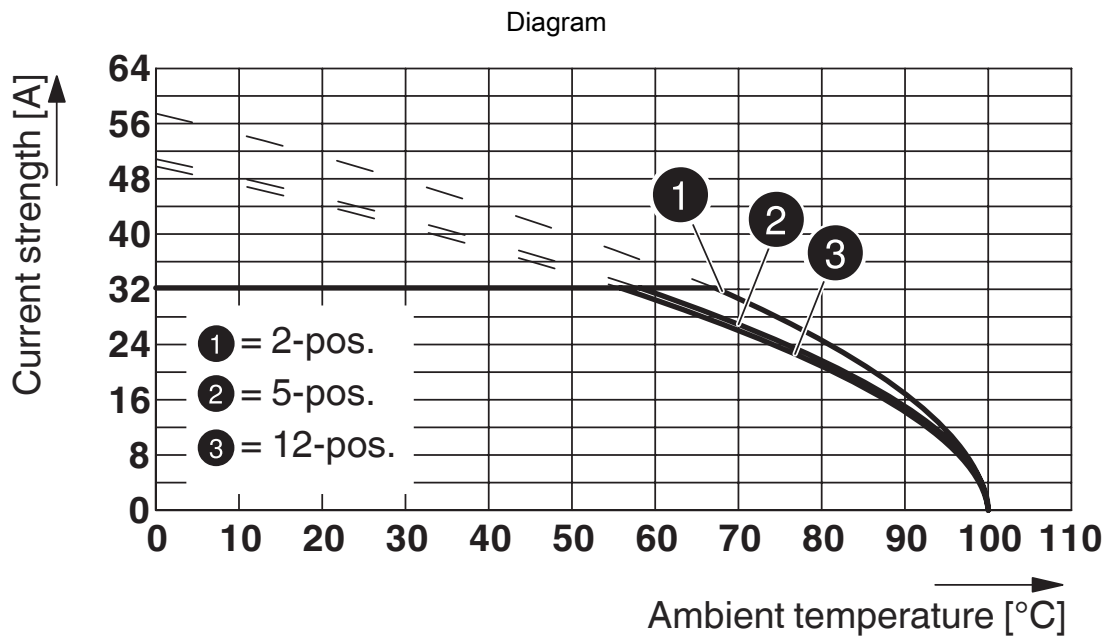

Type: PC 5/...-ST1-7,62 with PC 5/...-GU-7,62 P26 THT R..  
Conductor cross section: 6 mm<sup>2</sup>

# PC 5/ 2-ST1-7,62 - PCB connector



1777723

<https://www.phoenixcontact.com/in/products/1777723>

## Approvals



**EAC**

Approval ID: B.01687



**cULus Recognized**

Approval ID: E60425-19920722

	Nominal Voltage $U_N$	Nominal Current $I_N$	Cross Section AWG	Cross Section $\text{mm}^2$
	600 V	41 A	24 - 12	-
	-	41 A	24 - 8	-
	600 V	41 A	24 - 12	-
	-	41 A	24 - 8	-



# PC 5/ 2-ST1-7,62 - PCB connector



1777723

<https://www.phoenixcontact.com/in/products/1777723>

## Classifications

### ECLASS

ECLASS-11.0	27460202
ECLASS-12.0	27460202
ECLASS-13.0	27460202

### ETIM

ETIM 8.0	EC002638
----------	----------

### UNSPSC

UNSPSC 21.0	39121400
-------------	----------

# PC 5/ 2-ST1-7,62 - PCB connector



1777723

<https://www.phoenixcontact.com/in/products/1777723>

## Environmental Product Compliance

China RoHS	Environmentally friendly use period: unlimited = EFUP-e
	No hazardous substances above threshold values

# PC 5/ 2-ST1-7,62 - PCB connector

1777723

<https://www.phoenixcontact.com/in/products/1777723>

## Accessories

### SZS 0,6X3,5 - Screwdriver

1205053

<https://www.phoenixcontact.com/in/products/1205053>



Actuation tool, for ST terminal blocks, insulated, also suitable for use as a bladed screwdriver, size: 0.6 x 3.5 x 100 mm, 2-component grip, with non-slip grip

---

### CP-PC RD - Coding profile

1701967

<https://www.phoenixcontact.com/in/products/1701967>



Coding profile, for plugging into the coding ribs of the plug at a later date, insulating material, color: Red

# PC 5/ 2-ST1-7,62 - PCB connector

1777723

<https://www.phoenixcontact.com/in/products/1777723>

## SK 7,62/3,8:FORTL.ZAHLEN - Marker card

0804549

<https://www.phoenixcontact.com/in/products/0804549>

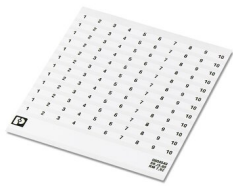

Marker card, white, labeled, horizontal: consecutive numbers 1 ... 10, 11 ... 20, etc. up to 91 ... 100, mounting type: adhesive, for terminal block width: 7.62 mm, lettering field size: 7.62 x 3.8 mm

---

## SK 3,8 REEL P7,62 WH CUS - Marker card

0825128

<https://www.phoenixcontact.com/in/products/0825128>



Marker card, can be ordered: by card, white, labeled according to customer specifications, mounting type: adhesive, for terminal block width: 7.62 mm, lettering field size: continuous x 3.8 mm

# PC 5/ 2-ST1-7,62 - PCB connector

1777723

<https://www.phoenixcontact.com/in/products/1777723>

## SK U/3,8 WH:UNBEDRUCKT - Marker card

0803906

<https://www.phoenixcontact.com/in/products/0803906>



Marker card, Sheet, white, unlabeled, can be labeled with: PLOTMARK, CMS-P1-PLOTTER, Office printing systems, mounting type: adhesive, for terminal block width: 210 mm, lettering field size: 186 x 3.8 mm, Number of individual labels: 1440

---

## SK 3,8 WH:REEL - Marker strip

0805218

<https://www.phoenixcontact.com/in/products/0805218>



Marker strip, Roll, white, unlabeled, can be labeled with: THERMOMARK E.300 (D)/600 (D), THERMOMARK ROLL 2.0, THERMOMARK ROLL, THERMOMARK ROLL X1, THERMOMARK ROLLMASTER 300/600, THERMOMARK X1.2, mounting type: adhesive, for terminal block width: 90000 mm, lettering field size: continuous x 3.8 mm, Number of individual labels: 210000

# PC 5/ 2-ST1-7,62 - PCB connector

1777723

<https://www.phoenixcontact.com/in/products/1777723>



## IPC 5/ 2-ST-7,62 - PCB connector

1709047

<https://www.phoenixcontact.com/in/products/1709047>

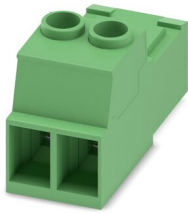

PCB connector, nominal cross section: 6 mm<sup>2</sup>, color: green, nominal current: 41 A, rated voltage (III/2): 1000 V, contact surface: Tin, type of contact: Pin, number of potentials: 2, number of rows: 1, number of positions: 2, number of connections: 2, product range: IPC 5/..-ST, pitch: 7.62 mm, connection method: Screw connection with tension sleeve, screw head form: Z1L Slotted Pozidriv, conductor/PCB connection direction: 0 °, locking clip: - without locking clip, plug-in system: COMBICON PC 5, locking: without, mounting: without, type of packaging: packed in cardboard

## ISPC 5/ 2-STGCL-7,62 - PCB connector

1748862

<https://www.phoenixcontact.com/in/products/1748862>



PCB connector, nominal cross section: 6 mm<sup>2</sup>, color: green, nominal current: 41 A, rated voltage (III/2): 1000 V, contact surface: Tin, type of contact: Pin, number of potentials: 2, number of rows: 1, number of positions: 2, number of connections: 2, product range: ISPC 5/..-STGCL, pitch: 7.62 mm, connection method: Push-in spring connection, conductor/PCB connection direction: 0 °, locking clip: - without locking clip, plug-in system: COMBICON PC 5, locking: Clip locking, mounting: Click & Lock latching window, type of packaging: packed in cardboard

Phoenix Contact 2023 © - all rights reserved  
<https://www.phoenixcontact.com>

PHOENIX CONTACT (I) Pvt. Ltd.  
A-58/2, Okhla Industrial Area, Phase - II, New Delhi-110 020

+91.1275.71420  
[info@phoenixcontact.co.in](mailto:info@phoenixcontact.co.in)