

MSTB 2,5/ 7-ST-5,08 - PCB connector



1757064

<https://www.phoenixcontact.com/in/products/1757064>

Please be informed that the data shown in this PDF document is generated from our Online Catalog. Please find the complete data in the user documentation. Our General Terms of Use for Downloads are valid.

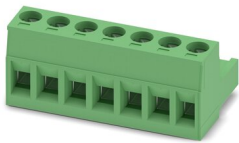

PCB connector, nominal cross section: 2.5 mm², color: green, nominal current: 12 A, rated voltage (III/2): 320 V, contact surface: Tin, type of contact: Socket, number of potentials: 7, number of rows: 1, number of positions: 7, number of connections: 7, product range: MSTB 2,5/..-ST, pitch: 5.08 mm, connection method: Screw connection with tension sleeve, screw head form: L Slotted, conductor/PCB connection direction: 0 °, locking clip: - Locking clip, plug-in system: COMBICON MSTB 2,5, locking: without, mounting: without, type of packaging: packed in cardboard

Your advantages

- Well-known connection principle allows worldwide use
- Low temperature rise, thanks to maximum contact force
- Allows connection of two conductors

Commercial Data

Item number	1757064
Packing unit	50 pc
Minimum order quantity	50 pc
Sales Key	AAC
Product Key	AACAGC
Catalog Page	Page 262 (C-1-2013)
GTIN	4017918029593
Weight per Piece (including packing)	12.035 g
Weight per Piece (excluding packing)	11.463 g
Customs tariff number	85366990
Country of origin	IN

MSTB 2,5/ 7-ST-5,08 - PCB connector



1757064

<https://www.phoenixcontact.com/in/products/1757064>

Technical Data

Product properties

Type	Standard
Product line	COMBICON Connectors M
Product type	PCB plug
Product family	MSTB 2,5/..-ST
Number of positions	7
Pitch	5.08 mm
Number of connections	7
Number of rows	1
Mounting flange	without
Number of potentials	7

Electrical properties

Nominal current I_N	12 A
Nominal voltage U_N	320 V
Degree of pollution	3
Contact resistance	1.3 m Ω
Rated voltage (III/3)	250 V
Rated surge voltage (III/3)	4 kV
Rated voltage (III/2)	320 V
Rated surge voltage (III/2)	4 kV
Rated voltage (II/2)	630 V
Rated surge voltage (II/2)	4 kV

Connection data

Connection technology

Type	Standard
Connector system	COMBICON MSTB 2,5
Nominal cross section	2.5 mm ²
Type of contact	Socket

Interlock

Locking type	without
Mounting flange	without

Conductor connection

Connection method	Screw connection with tension sleeve
Conductor/PCB connection direction	0 °
Conductor cross section rigid	0.2 mm ² ... 2.5 mm ²
Conductor cross section flexible	0.2 mm ² ... 2.5 mm ²
Conductor cross section AWG	24 ... 12
Conductor cross section flexible, with ferrule without plastic	0.25 mm ² ... 2.5 mm ²

MSTB 2,5/ 7-ST-5,08 - PCB connector

1757064

<https://www.phoenixcontact.com/in/products/1757064>

sleeve	
Conductor cross section, flexible, with ferrule, with plastic sleeve	0.25 mm ² ... 2.5 mm ²
2 conductors with same cross section, solid	0.2 mm ² ... 1 mm ²
2 conductors with same cross section, flexible	0.2 mm ² ... 1.5 mm ²
2 conductors with same cross section, flexible, with ferrule without plastic sleeve	0.25 mm ² ... 1 mm ²
2 conductors with the same cross section, flexible, with TWIN ferrule with plastic sleeve	0.5 mm ² ... 1.5 mm ²
Cylindrical gauge a x b / diameter	2.8 mm x 2.0 mm / 2.4 mm
Stripping length	7 mm
Tightening torque	0.5 Nm ... 0.6 Nm

Material specifications

Material data - contact

Note	WEEE/RoHS-compliant, free of whiskers according to IEC 60068-2-82/JEDEC JESD 201
Contact material	Cu alloy
Surface characteristics	hot-dip tin-plated
Metal surface terminal point (top layer)	Tin (5 - 7 µm Sn)
Metal surface contact area (top layer)	Tin (5 - 7 µm Sn)

Material data - housing

Color (Housing)	green (6021)
Insulating material	PA
Insulating material group	I
CTI according to IEC 60112	600
Flammability rating according to UL 94	V0
Glow wire flammability index GWFI according to EN 60695-2-12	850
Glow wire ignition temperature GWIT according to EN 60695-2-13	775
Temperature for the ball pressure test according to EN 60695-10-2	125 °C

Material data – actuating element

Color ()	()
-----------	-----

Dimensions

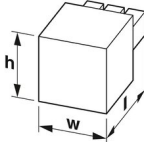
Dimensional drawing	
Pitch	5.08 mm
Width [w]	35.56 mm
Height [h]	15 mm

MSTB 2,5/ 7-ST-5,08 - PCB connector



1757064

<https://www.phoenixcontact.com/in/products/1757064>

Length [l]	18.3 mm
------------	---------

Mounting

Drive form screw head	Slotted (L)
Drive form screw head	Slotted (L)

Notes

Notes on operation	In accordance with IEC 61984, COMBICON connectors have no switching power (COC). During designated use, they must not be plugged in or disconnected when carrying voltage or under load.
--------------------	--

Mechanical tests

Test for conductor damage and slackening

Specification	IEC 60999-1:1999-11
Result	Test passed

Pull-out test

Specification	IEC 60999-1:1999-11
Conductor cross section/conductor type/tractive force setpoint/actual value	0.2 mm ² / solid / > 10 N
	0.2 mm ² / flexible / > 10 N
	2.5 mm ² / solid / > 50 N
	2.5 mm ² / flexible / > 50 N

Insertion and withdrawal forces

Result	Test passed
No. of cycles	25
Insertion strength per pos. approx.	8 N
Withdraw strength per pos. approx.	6 N

Torque test

Specification	IEC 60999-1:1999-11
---------------	---------------------

Contact holder in insert

Specification	IEC 60512-15-1:2008-05
Contact holder in insert Requirements >20 N	Test passed

Resistance of inscriptions

Specification	IEC 60068-2-70:1995-12
Result	Test passed

Polarization and coding

Specification	IEC 60512-13-5:2006-02
Result	Test passed

Visual inspection

Specification	IEC 60512-1-1:2002-02
Result	Test passed

MSTB 2,5/ 7-ST-5,08 - PCB connector



1757064

<https://www.phoenixcontact.com/in/products/1757064>

Dimension check

Specification	IEC 60512-1-2:2002-02
Result	Test passed

Environmental and real-life conditions

Vibration test

Specification	IEC 60068-2-6:2007-12
Frequency	10 - 150 - 10 Hz
Sweep speed	1 octave/min
Amplitude	0.35 mm (10 Hz ... 60.1 Hz)
Sweep speed	5g (60.1 Hz ... 150 Hz)
Test duration per axis	2.5 h

Durability test

Specification	IEC 60512-9-1:2010-03
Impulse withstand voltage at sea level	4.8 kV
Contact resistance R_1	1.3 m Ω
Contact resistance R_2	1.4 m Ω
Insertion/withdrawal cycles	25

Climatic test

Specification	ISO 6988:1985-02
Corrosive stress	0.2 dm ³ SO ₂ on 300 dm ³ /40 °C/1 cycle
Thermal stress	100 °C/168 h
Power-frequency withstand voltage	2.21 kV

Ambient conditions

Ambient temperature (operation)	-40 °C ... 100 °C (dependent on the derating curve)
Ambient temperature (storage/transport)	-40 °C ... 70 °C
Relative humidity (storage/transport)	30 % ... 70 %
Ambient temperature (assembly)	-5 °C ... 100 °C

Electrical tests

Thermal test | Test group C

Specification	IEC 60512-5-1:2002-02
Tested number of positions	12

Insulation resistance

Specification	IEC 60512-3-1:2002-02
Insulation resistance, neighboring positions	> 5 M Ω

Air clearances and creepage distances |

Specification	IEC 60664-1:2007-04
Insulating material group	I
Comparative tracking index (IEC 60112)	CTI 600

MSTB 2,5/ 7-ST-5,08 - PCB connector



1757064

<https://www.phoenixcontact.com/in/products/1757064>

Rated insulation voltage (III/3)	250 V
Rated surge voltage (III/3)	4 kV
minimum clearance value - non-homogenous field (III/3)	3 mm
minimum creepage distance (III/3)	3.2 mm
Rated insulation voltage (III/2)	320 V
Rated surge voltage (III/2)	4 kV
minimum clearance value - non-homogenous field (III/2)	3 mm
minimum creepage distance (III/2)	3 mm
Rated insulation voltage (II/2)	630 V
Rated surge voltage (II/2)	4 kV
minimum clearance value - non-homogenous field (II/2)	3 mm
minimum creepage distance (II/2)	3.2 mm

Packaging specifications

Type of packaging	packed in cardboard
-------------------	---------------------

MSTB 2,5/ 7-ST-5,08 - PCB connector



1757064

<https://www.phoenixcontact.com/in/products/1757064>

Drawings

Diagram

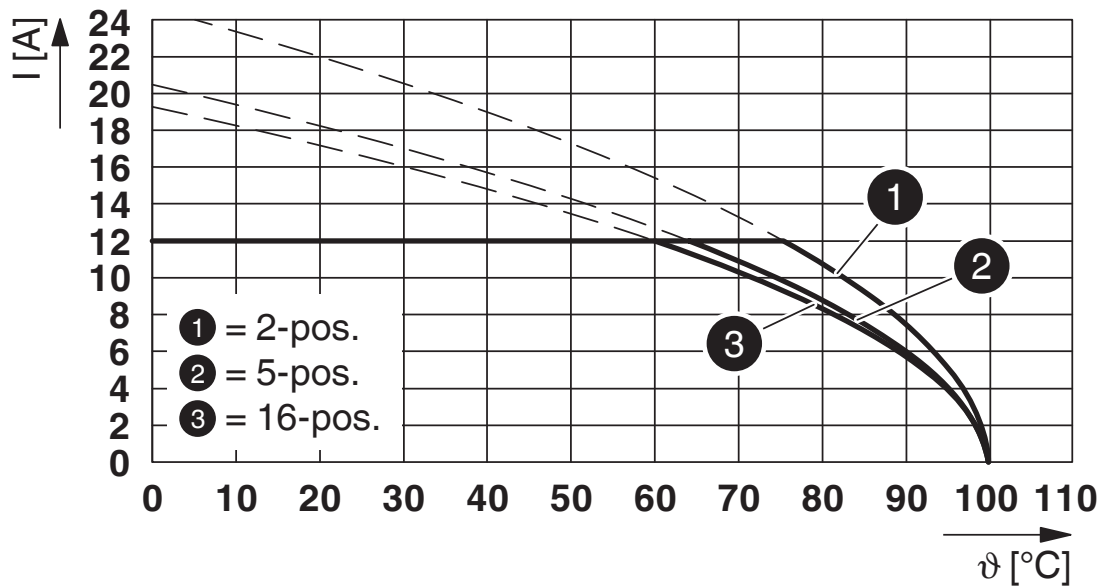

Type: MSTB 2,5/...-ST-5,08 with DFK-MSTBA 2,5/...-G-5,08

Diagram

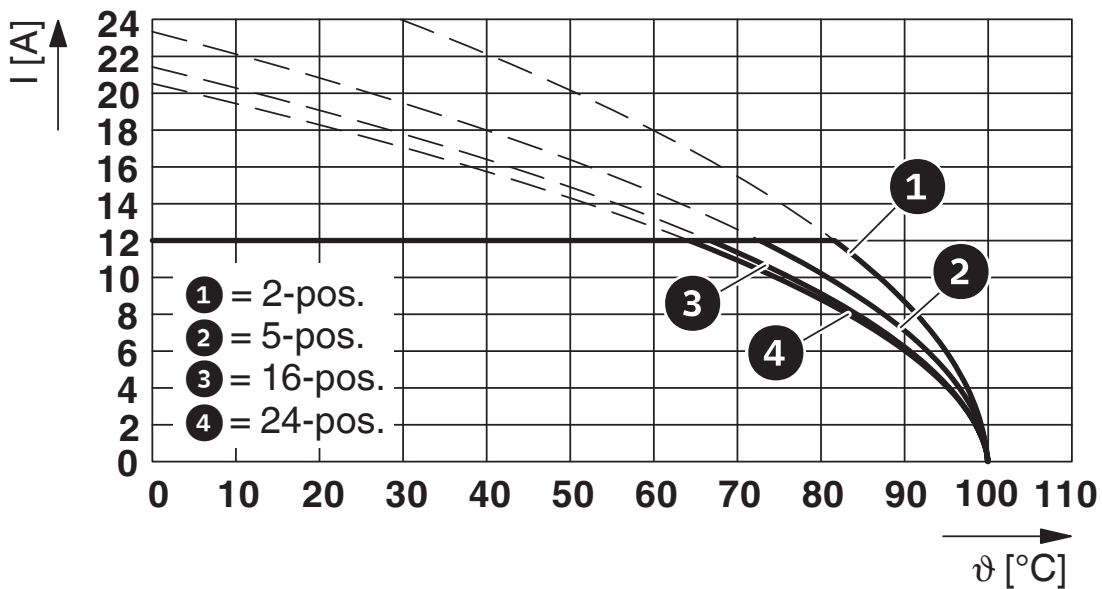

Type: MSTB 2,5/...-ST-5,08 with SMSTBA 2,5/...-G-5,08

MSTB 2,5/ 7-ST-5,08 - PCB connector



1757064

<https://www.phoenixcontact.com/in/products/1757064>

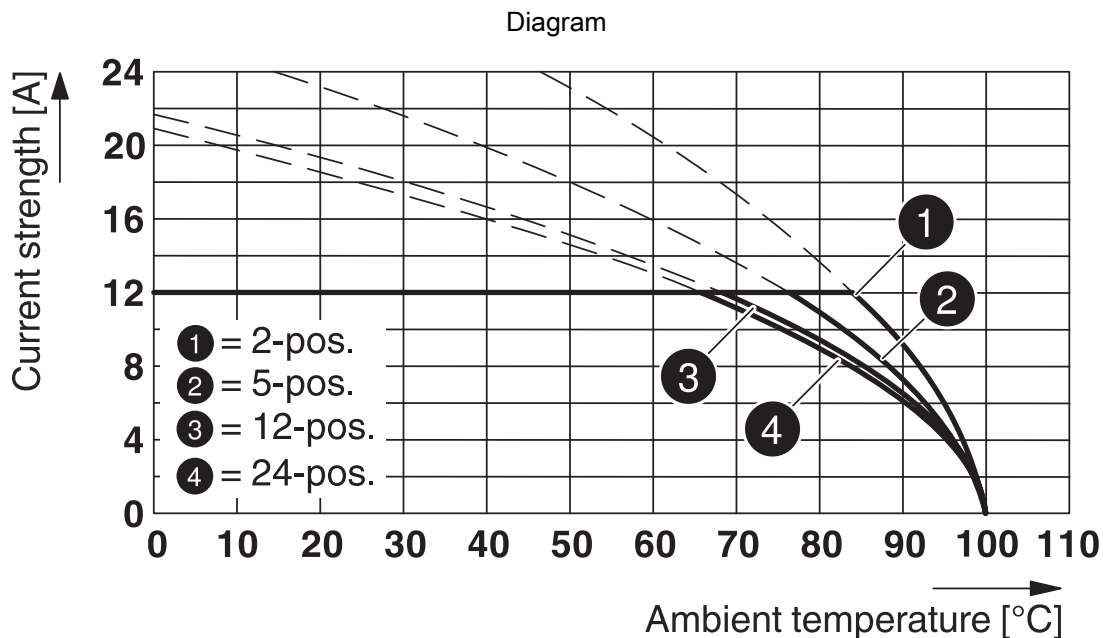

Type: MSTB 2,5/...-ST-5,08 with CCVA 2,5/...-G-5,08 P26THR

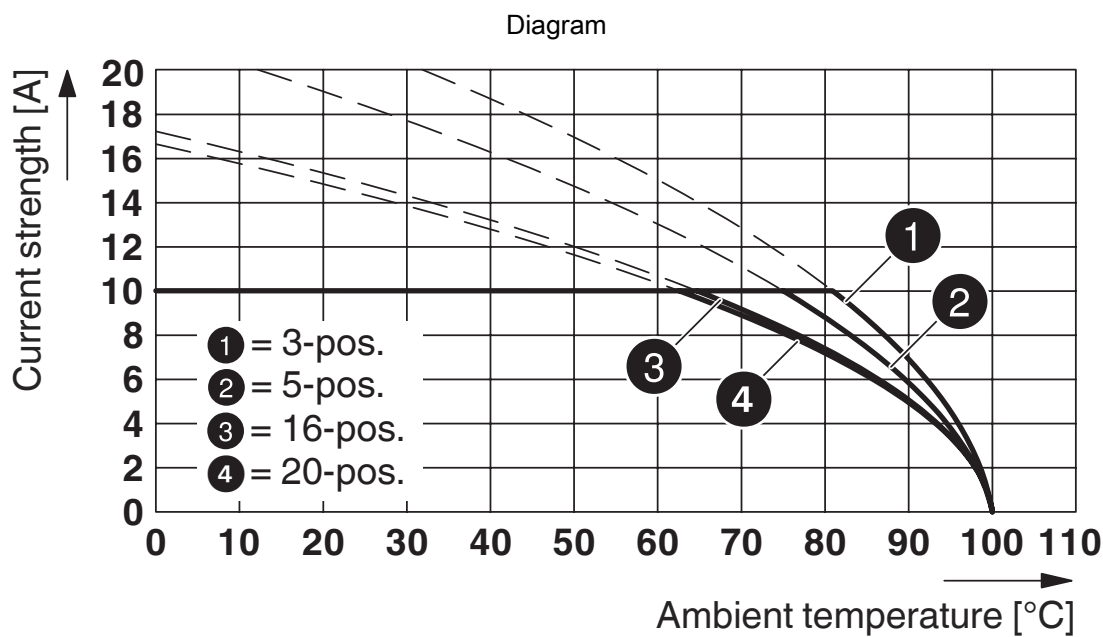

Type: MSTB 2,5/...-ST-5,08 with MDSTBV 2,5/...-G1-5,08

MSTB 2,5/ 7-ST-5,08 - PCB connector



1757064

<https://www.phoenixcontact.com/in/products/1757064>

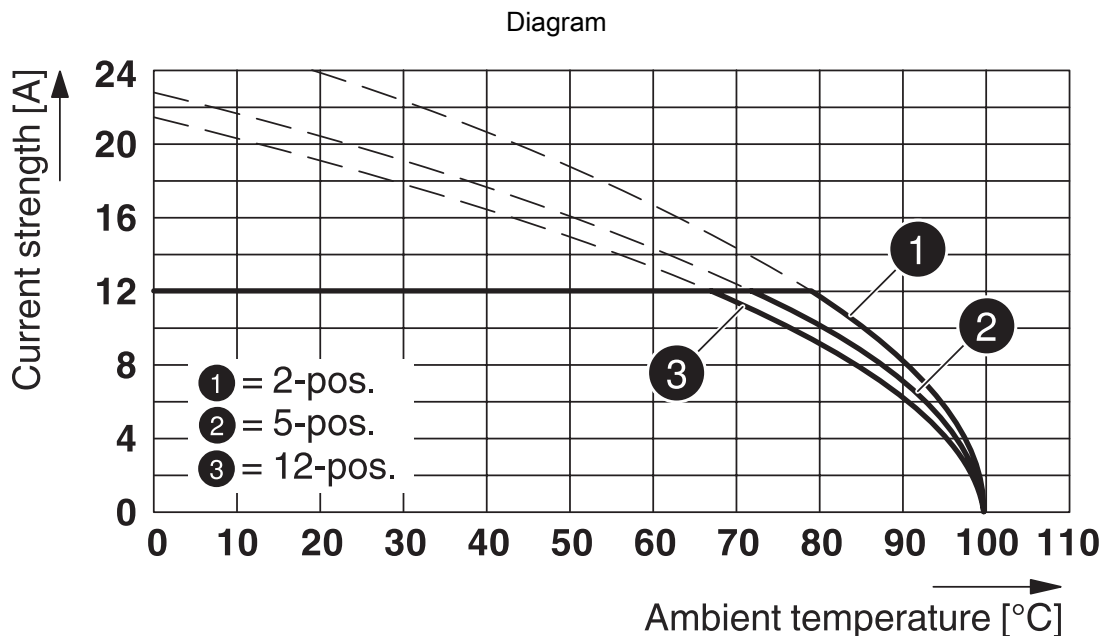

Type: MSTB 2,5/...-ST-5,08 with CCV 2,5/...-G-5,08 P26THR

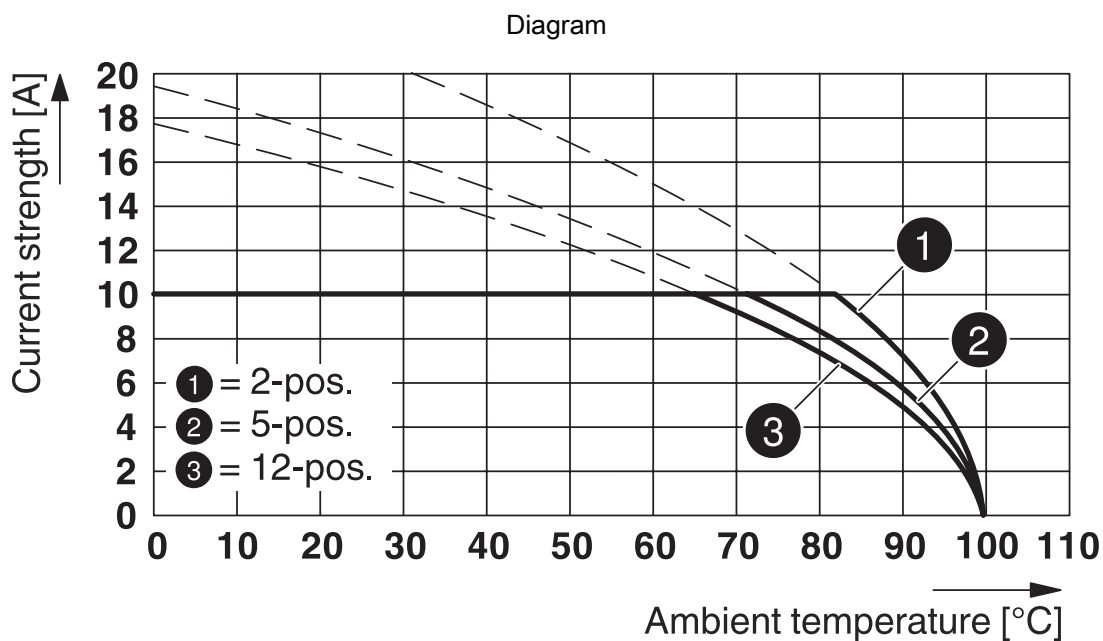

Type: MSTB 2,5/...-ST-5,08 with MDSTBA 2,5/...-G-5,08

MSTB 2,5/ 7-ST-5,08 - PCB connector



1757064

<https://www.phoenixcontact.com/in/products/1757064>

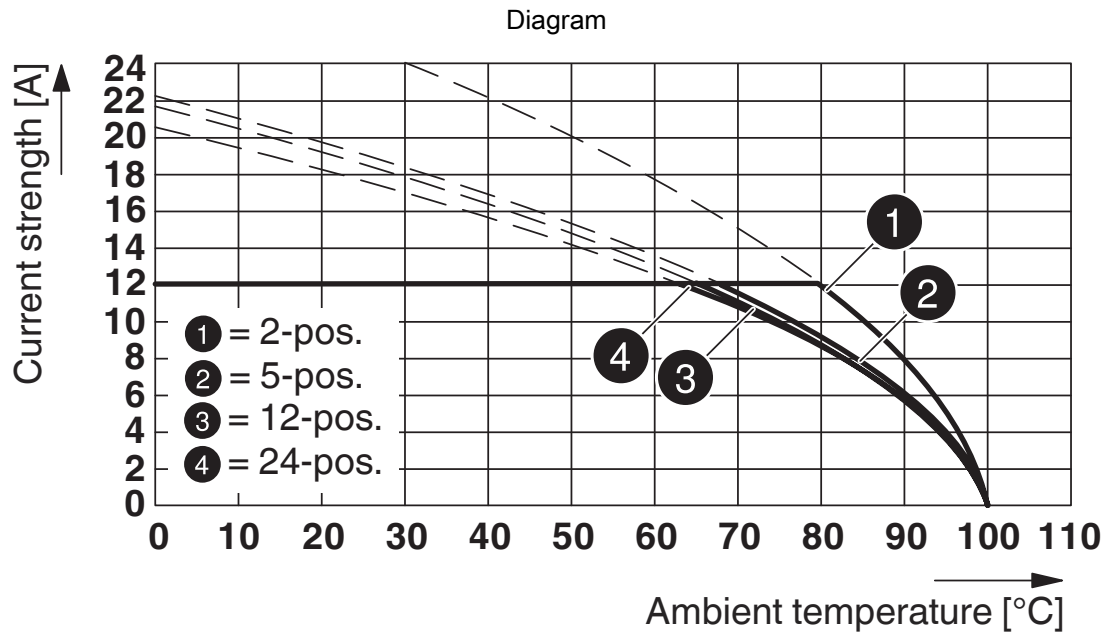

Type: MSTB 2,5/...-ST-5,08 with MSTB 2,5/...-G-5,08

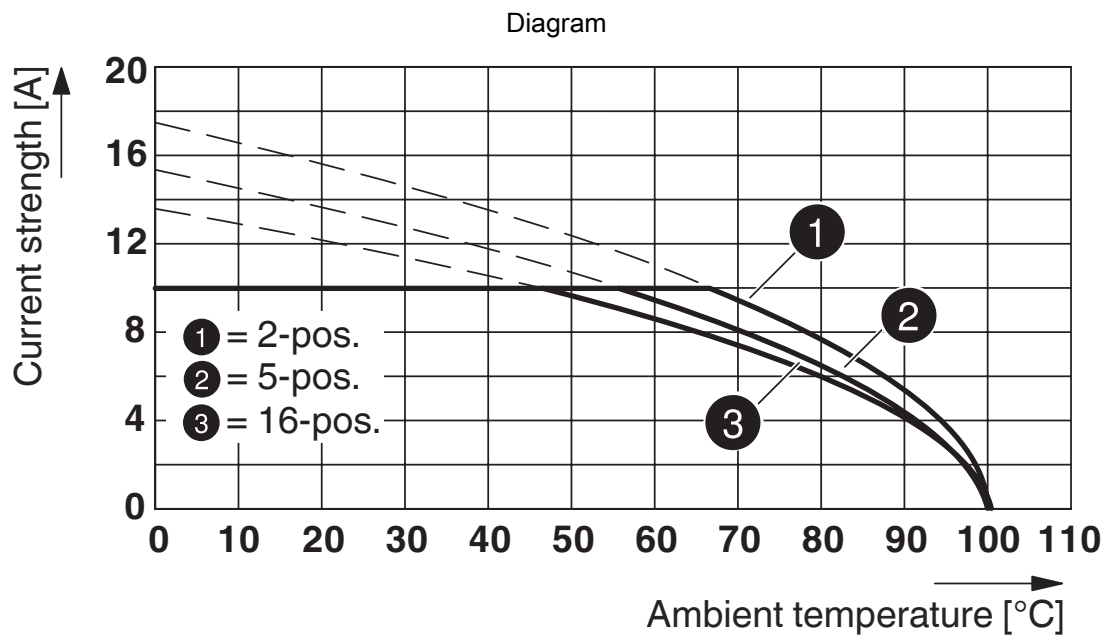

Type: MSTB 2,5/...-ST-5,08 with MDSTBV 2,5/...-G-5,08

MSTB 2,5/ 7-ST-5,08 - PCB connector



1757064

<https://www.phoenixcontact.com/in/products/1757064>

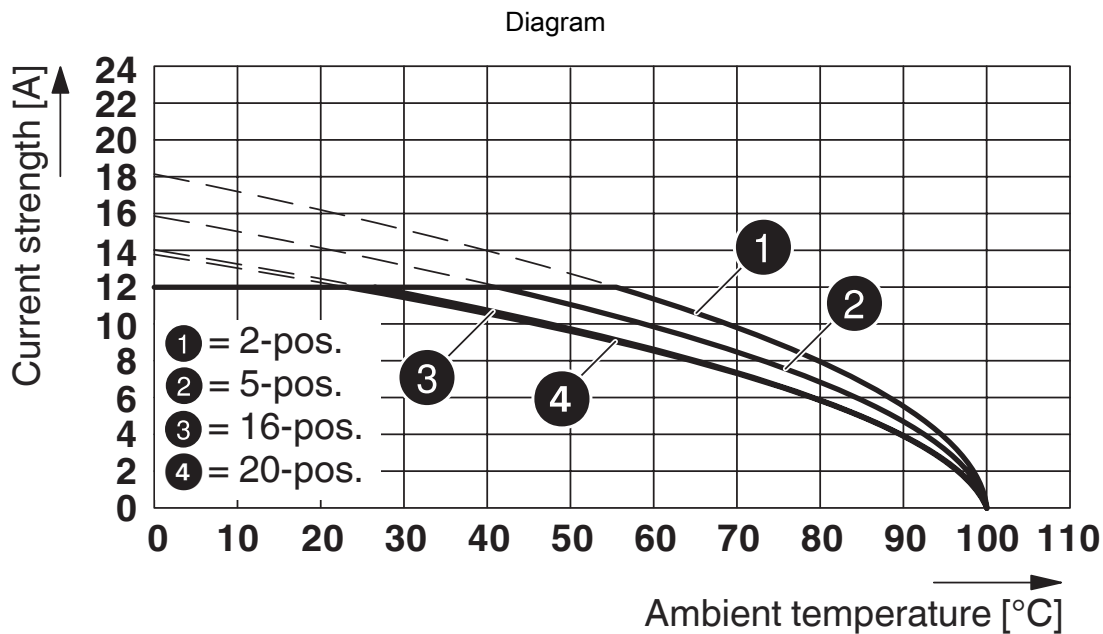

Type: MSTB 2,5/...-ST-5,08 with MSTBV 2,5/...-G-5,08

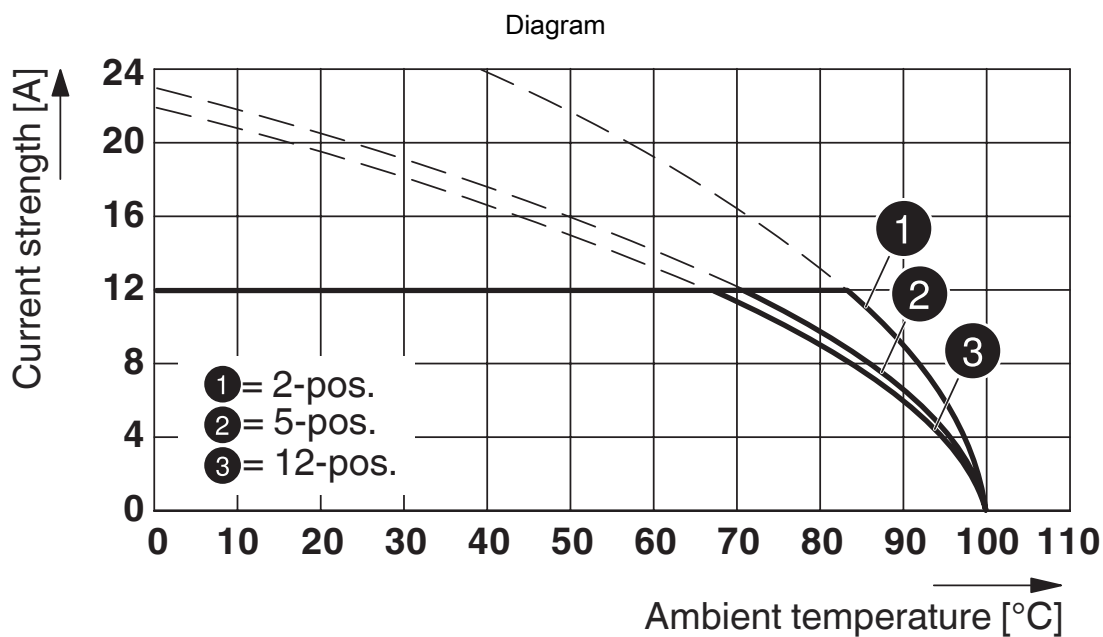

Type: MSTB 2,5/...-ST-5,08 with CC 2,5/...-G-5,08 P26THR

MSTB 2,5/ 7-ST-5,08 - PCB connector



1757064

<https://www.phoenixcontact.com/in/products/1757064>

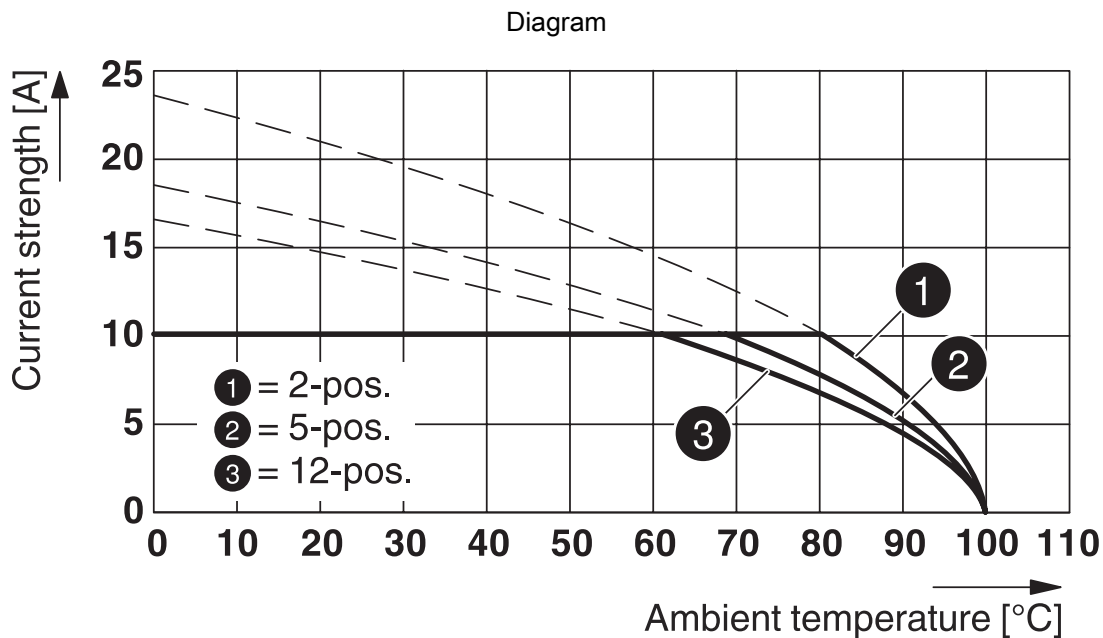

Type: MSTB 2,5/...-ST-5,08 with MDSTB 2,5/...-G-5,08

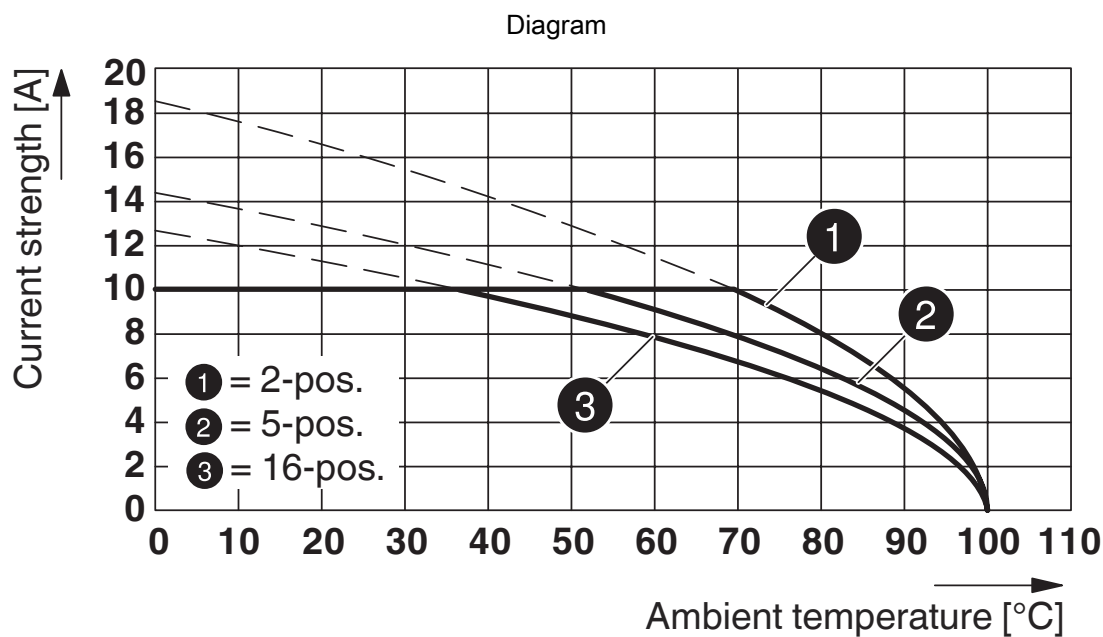

Type: MSTB 2,5/...-ST-5,08 with MDSTBVA 2,5/...-G-5,08

MSTB 2,5/ 7-ST-5,08 - PCB connector



1757064

<https://www.phoenixcontact.com/in/products/1757064>

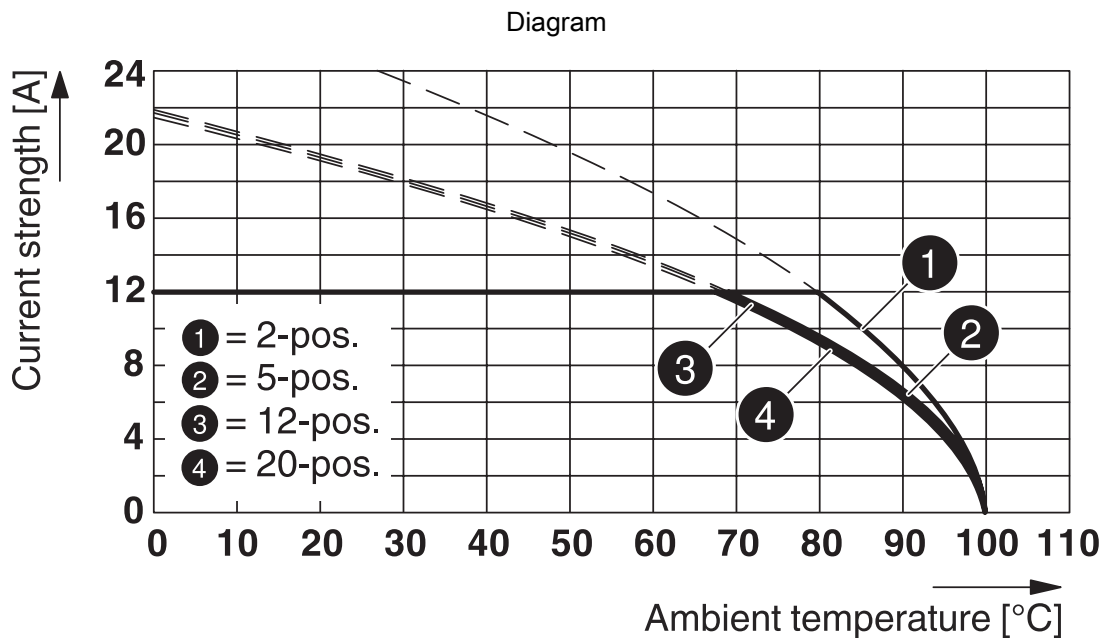

Type: MSTB 2,5/...-ST-5,08 with MVSTBU 2,5/...-GB-5,08

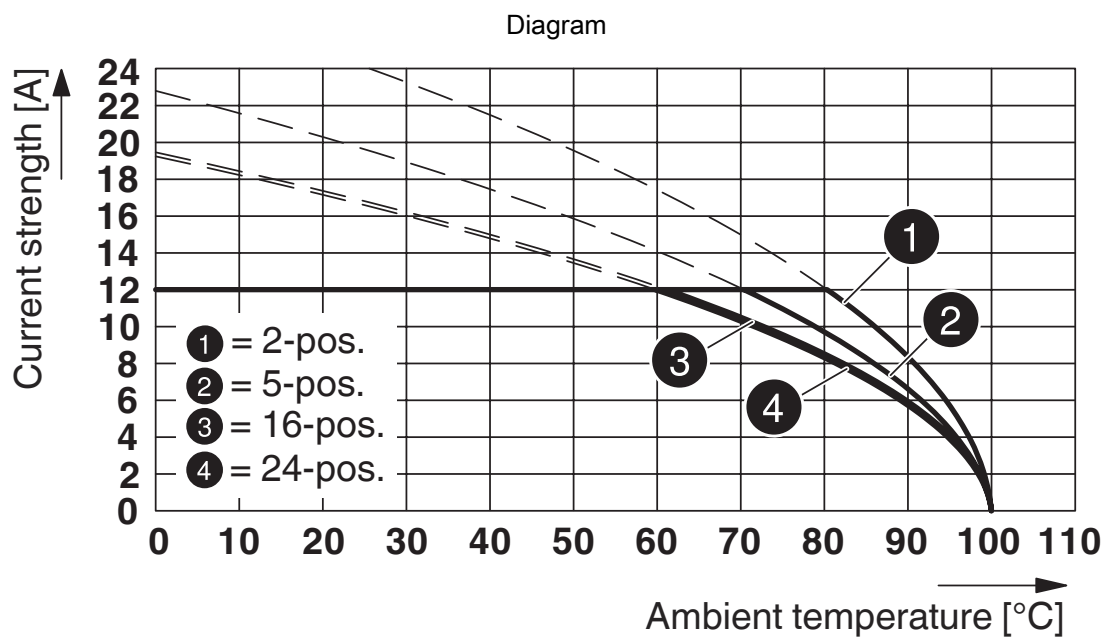

Type: MSTB 2,5/...-ST-5,08 with MSTBW 2,5/...-G-5,08

MSTB 2,5/ 7-ST-5,08 - PCB connector



1757064

<https://www.phoenixcontact.com/in/products/1757064>

Diagram

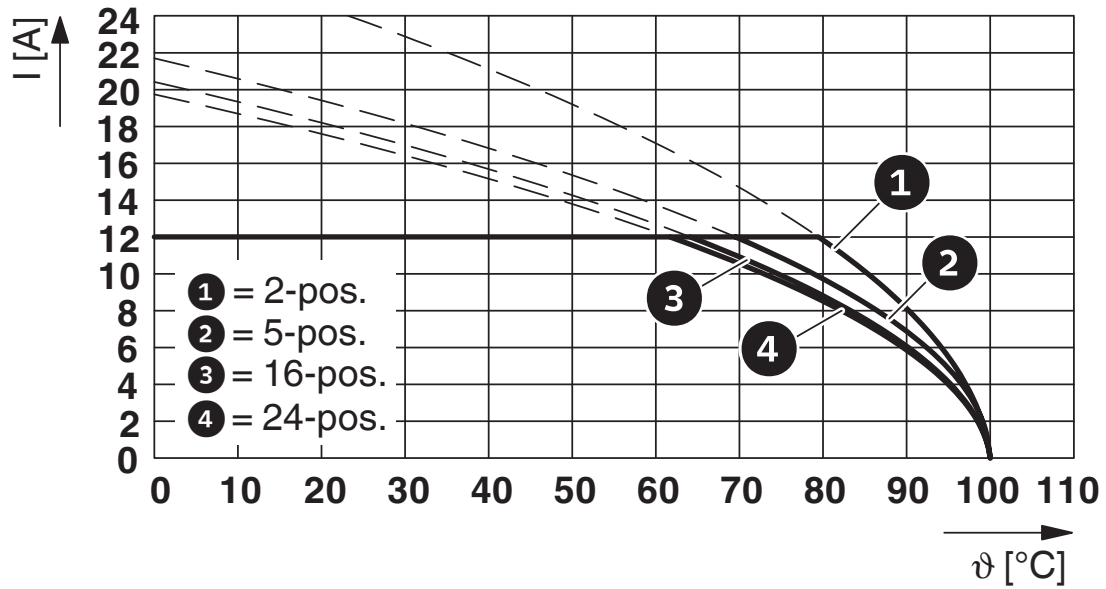

Type: MSTB 2,5/...-ST-5,08 with SMSTB 2,5/...-G-5,08

Diagram

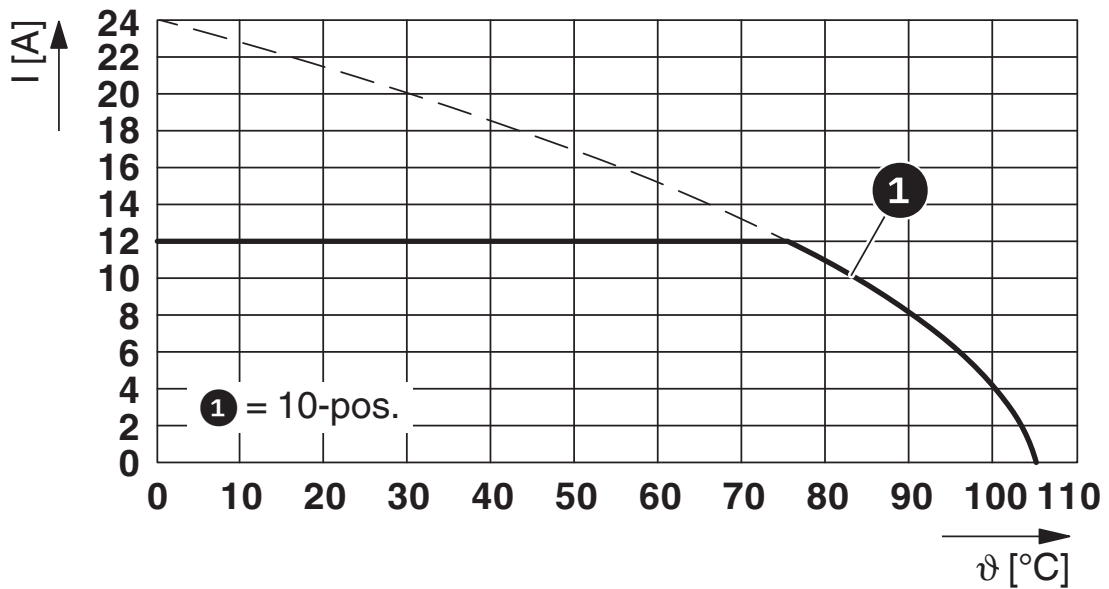

Type: MSTB 2,5/...-ST-5,08 with MSTBHK 2,5/...-G-5,08

MSTB 2,5/ 7-ST-5,08 - PCB connector



1757064

<https://www.phoenixcontact.com/in/products/1757064>

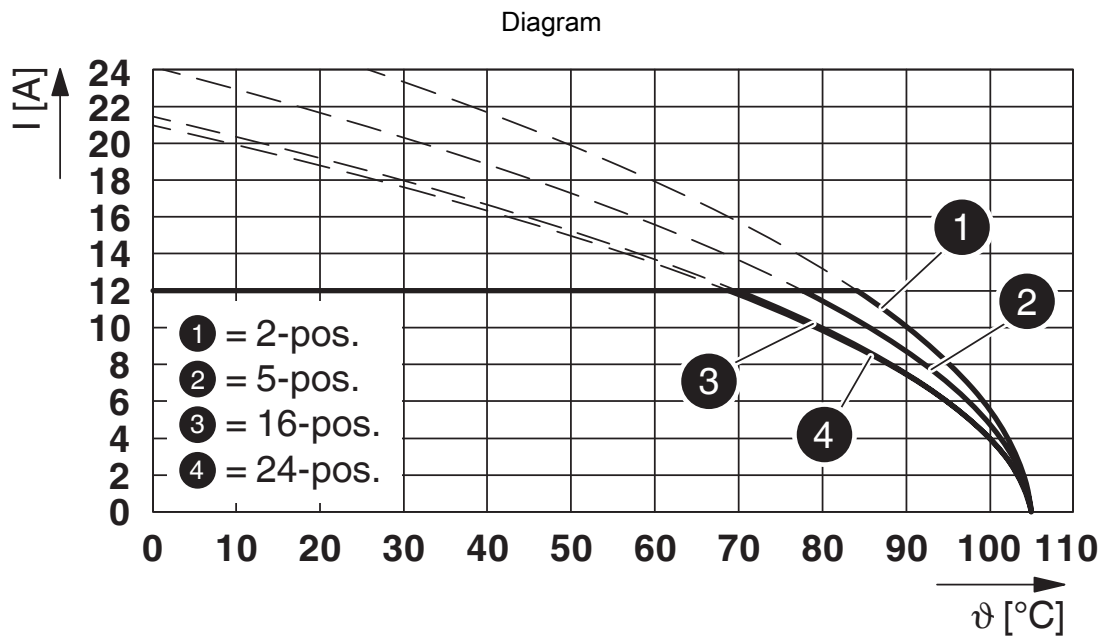

Type: MSTB 2,5/...-ST-5,08 with MSTBA 2,5/...-G-5,08

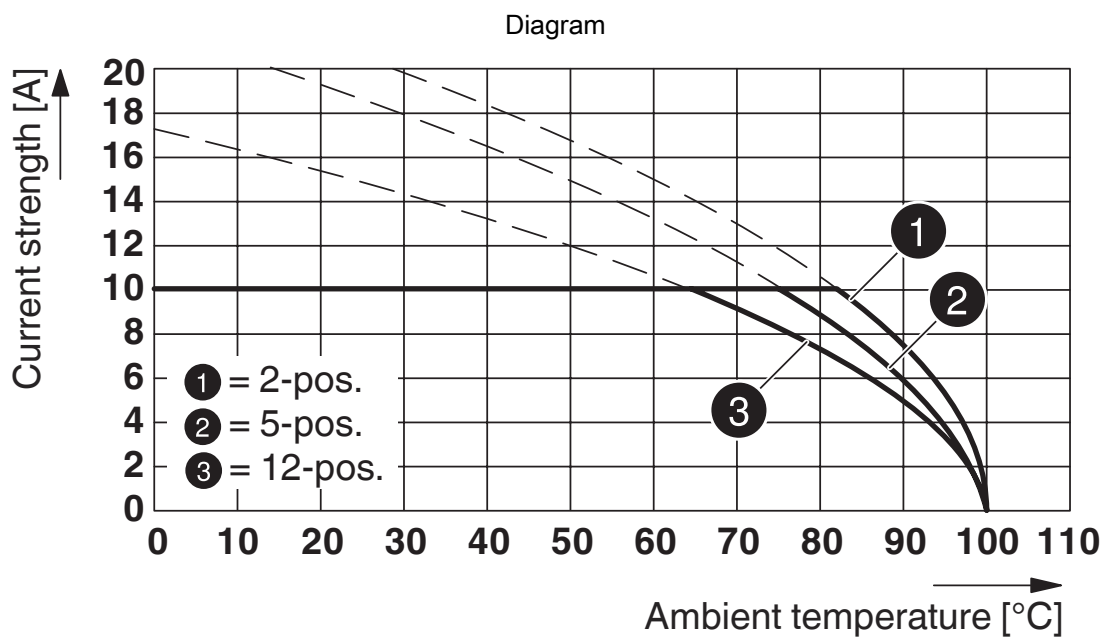

Type: MSTB 2,5/...-ST-5,08 with MDSTBW 2,5/...-G-5,08

1757064

<https://www.phoenixcontact.com/in/products/1757064>

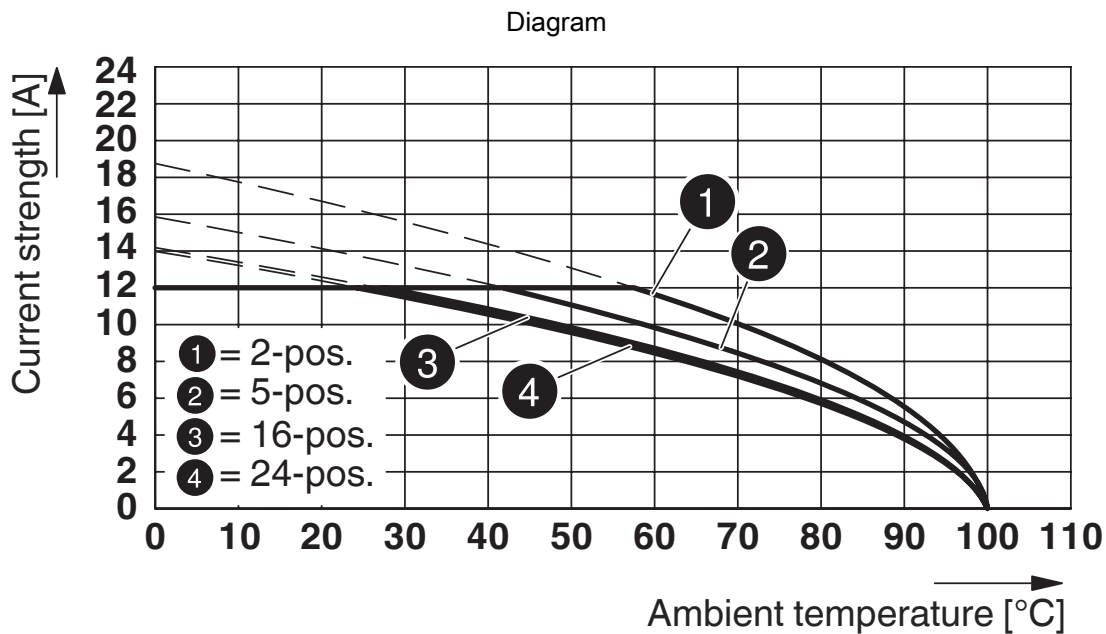

Type: MSTB 2,5/...-ST-5,08 with MSTBVA 2,5/...-G-5,08

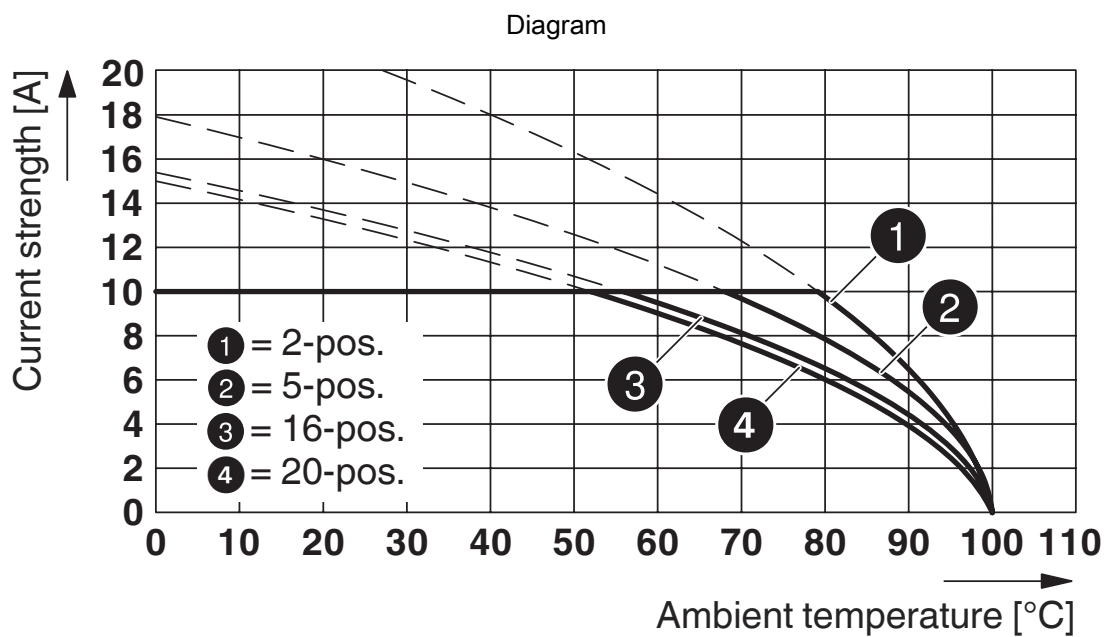

Type: MSTB 2,5/...-ST-5,08 with MDSTB 2,5/...-G1-5,08

MSTB 2,5/ 7-ST-5,08 - PCB connector



1757064

<https://www.phoenixcontact.com/in/products/1757064>

Approvals

 CSA Approval ID: 13631				
	Nominal Voltage U_N	Nominal Current I_N	Cross Section AWG	Cross Section mm^2
	300 V	15 A	28 - 12	-
	300 V	10 A	28 - 12	-

 IECEE CB Scheme Approval ID: DE1-60988-B1B2				
	Nominal Voltage U_N	Nominal Current I_N	Cross Section AWG	Cross Section mm^2
	250 V	12 A	-	0.2 - 2.5

 EAC Approval ID: B.01687				
--	--	--	--	--

 cULus Recognized Approval ID: E60425-19931011				
	Nominal Voltage U_N	Nominal Current I_N	Cross Section AWG	Cross Section mm^2
	300 V	15 A	30 - 12	-
	300 V	10 A	30 - 12	-

 VDE Zeichengenehmigung Approval ID: 40050694				
	Nominal Voltage U_N	Nominal Current I_N	Cross Section AWG	Cross Section mm^2
	250 V	12 A	-	0.2 - 2.5

MSTB 2,5/ 7-ST-5,08 - PCB connector



1757064

<https://www.phoenixcontact.com/in/products/1757064>

Classifications

ECLASS

ECLASS-11.0	27460202
ECLASS-12.0	27460202
ECLASS-13.0	27460202

ETIM

ETIM 8.0	EC002638
----------	----------

UNSPSC

UNSPSC 21.0	39121400
-------------	----------

MSTB 2,5/ 7-ST-5,08 - PCB connector



1757064

<https://www.phoenixcontact.com/in/products/1757064>

Environmental Product Compliance

China RoHS	Environmentally Friendly Use Period = 50 years For information on hazardous substances, refer to the manufacturer's declaration available under "Downloads"
------------	--

MSTB 2,5/ 7-ST-5,08 - PCB connector

1757064

<https://www.phoenixcontact.com/in/products/1757064>

Accessories

 Note: Applying some accessories below might limit this product.

EBP 2- 5 - Insertion bridge

1733169

<https://www.phoenixcontact.com/in/products/1733169>

Insertion bridge for connectors with 5.0 mm or 5.08 mm pitch



 Max. current carrying capacity: 12 A

EBP 3- 5 - Insertion bridge

1733172

<https://www.phoenixcontact.com/in/products/1733172>

Insertion bridge for connectors with 5.0 mm or 5.08 mm pitch



 Max. current carrying capacity: 12 A

MSTB 2,5/ 7-ST-5,08 - PCB connector

1757064

<https://www.phoenixcontact.com/in/products/1757064>



EBP 4- 5 - Insertion bridge

1733185

<https://www.phoenixcontact.com/in/products/1733185>



Insertion bridge for connectors with 5.0 mm or 5.08 mm pitch

 Max. current carrying capacity: 12 A

EBP 5- 5 - Insertion bridge

1733198

<https://www.phoenixcontact.com/in/products/1733198>



Insertion bridge for connectors with 5.0 mm or 5.08 mm pitch

 Max. current carrying capacity: 12 A

MSTB 2,5/ 7-ST-5,08 - PCB connector

1757064

<https://www.phoenixcontact.com/in/products/1757064>



SZS 0,6X3,5 - Screwdriver

1205053

<https://www.phoenixcontact.com/in/products/1205053>



Actuation tool, for ST terminal blocks, insulated, also suitable for use as a bladed screwdriver, size: 0.6 x 3.5 x 100 mm, 2-component grip, with non-slip grip

SK 5,08/3,8:FORTL.ZAHLEN - Marker card

0804293

<https://www.phoenixcontact.com/in/products/0804293>

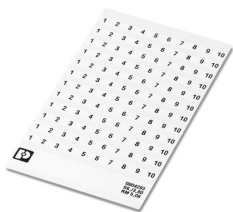

Marker card, white, labeled, horizontal: consecutive numbers 1 ... 10, 11 ... 20, etc. up to 91 ... (99)100, mounting type: adhesive, for terminal block width: 5.08 mm, lettering field size: 5.08 x 3.8 mm

MSTB 2,5/ 7-ST-5,08 - PCB connector

1757064

<https://www.phoenixcontact.com/in/products/1757064>



KGG-MSTB 2,5/ 7 - Cable housing

1803918

<https://www.phoenixcontact.com/in/products/1803918>

Cable housing, pitch: 0 mm, number of positions: 7, color: green



CP-MSTB - Coding profile

1734634

<https://www.phoenixcontact.com/in/products/1734634>

Coding profile, is inserted into the slot on the plug or inverted header, red insulating material



MSTB 2,5/ 7-ST-5,08 - PCB connector

1757064

<https://www.phoenixcontact.com/in/products/1757064>



SK U/2,8 WH:UNBEDRUCKT - Marker card

0803883

<https://www.phoenixcontact.com/in/products/0803883>



Marker card, Sheet, white, unlabeled, can be labeled with: PLOTMARK, CMS-P1-PLOTTER, Office printing systems, mounting type: adhesive, for terminal block width: 210 mm, lettering field size: 186 x 2.8 mm, Number of individual labels: 3600

MSTBW 2,5/ 7-G-5,08 - PCB header

1735837

<https://www.phoenixcontact.com/in/products/1735837>

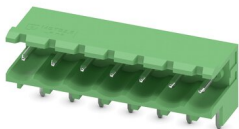

PCB headers, nominal cross section: 2.5 mm², color: green, nominal current: 12 A, rated voltage (III/2): 320 V, contact surface: Tin, type of contact: Pin, number of potentials: 7, number of rows: 1, number of positions: 7, number of connections: 7, product range: MSTBW 2,5/...-G, pitch: 5.08 mm, mounting: Wave soldering, pin layout: Linear pinning, solder pin [P]: 3.5 mm, number of solder pins per potential: 1, plug-in system: COMBICON MSTB 2,5, Pin connector pattern alignment: Standard, locking: without, mounting: without, type of packaging: packed in cardboard

MSTB 2,5/ 7-ST-5,08 - PCB connector



1757064

<https://www.phoenixcontact.com/in/products/1757064>

MSTBVA 2,5/ 7-G-5,08 - PCB header

1755781

<https://www.phoenixcontact.com/in/products/1755781>

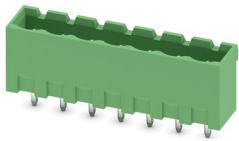

PCB headers, nominal cross section: 2.5 mm², color: green, nominal current: 12 A, rated voltage (III/2): 320 V, contact surface: Tin, type of contact: Pin, number of potentials: 7, number of rows: 1, number of positions: 7, number of connections: 7, product range: MSTBVA 2,5/..-G, pitch: 5.08 mm, mounting: Wave soldering, pin layout: Linear pinning, solder pin [P]: 3.9 mm, number of solder pins per potential: 1, plug-in system: COMBICON MSTB 2,5, Pin connector pattern alignment: Standard, locking: without, mounting: without, type of packaging: packed in cardboard

CCVA 2,5/ 7-G-5,08 P26THRR56 - PCB header

1956014

<https://www.phoenixcontact.com/in/products/1956014>



PCB headers, nominal cross section: 2.5 mm², color: black, nominal current: 12 A, rated voltage (III/2): 320 V, contact surface: Tin, type of contact: Pin, number of potentials: 7, number of rows: 1, number of positions: 7, number of connections: 7, product range: CCVA 2,5/..-G, pitch: 5.08 mm, mounting: THR soldering, pin layout: Linear pinning, solder pin [P]: 2.6 mm, number of solder pins per potential: 1, plug-in system: COMBICON MSTB 2,5, Pin connector pattern alignment: Standard, locking: without, mounting: without, type of packaging: 56 mm wide tape, For user information and design recommendations for through-hole reflow technology, go to: Downloads

Phoenix Contact 2023 © - all rights reserved
<https://www.phoenixcontact.com>

PHOENIX CONTACT (I) Pvt. Ltd.
A-58/2, Okhla Industrial Area, Phase - II, New Delhi-110 020

+91.1275.71420
info@phoenixcontact.co.in