

MSTBC 2,5/10-ST-5,08 - PCB connector



1808890

<https://www.phoenixcontact.com/in/products/1808890>

Please be informed that the data shown in this PDF document is generated from our Online Catalog. Please find the complete data in the user documentation. Our General Terms of Use for Downloads are valid.



PCB connector, nominal cross section: 2.5 mm², color: green, nominal current: 12 A, rated voltage (III/2): 320 V, type of contact: Socket, number of potentials: 10, number of rows: 1, number of positions: 10, number of connections: 10, product range: MSTBC 2,5/..-ST, pitch: 5.08 mm, connection method: Crimp connection, conductor/PCB connection direction: 0 °, locking clip: - Locking clip, plug-in system: COMBICON MSTB 2,5, locking: without, mounting: without, type of packaging: packed in cardboard, Corresponding female crimp contacts with current [A] and conductor cross section range [mm²] data: 10A/MSTBC-MT 0,5-1,0 (3190564); 10A/MSTBC-MT 0,5-1,0 BA (3190645); 12A/MSTBC-MT 1,5-2,5 (3190551); 12A/MSTBC-MT 1,5-2,5 BA (3190658). BA = Bandkontakte

Your advantages

- Inexpensive connection of large quantities of pre-assembled conductors

Commercial Data

Item number	1808890
Packing unit	50 pc
Minimum order quantity	50 pc
Sales Key	AAC
Product Key	AACCEA
Catalog Page	Page 294 (C-1-2013)
GTIN	4017918047245
Weight per Piece (including packing)	5.003 g
Weight per Piece (excluding packing)	5.003 g
Customs tariff number	85389099
Country of origin	PL

MSTBC 2,5/10-ST-5,08 - PCB connector



1808890

<https://www.phoenixcontact.com/in/products/1808890>

Technical Data

Product properties

Type	Standard
Product line	COMBICON Connectors M
Product type	PCB plug
Product family	MSTBC 2,5/..-ST
Number of positions	10
Pitch	5.08 mm
Number of connections	10
Number of rows	1
Mounting flange	without
Number of potentials	10

Electrical properties

Nominal current I_N	12 A
Nominal voltage U_N	320 V
Degree of pollution	3
Rated voltage (III/3)	320 V
Rated surge voltage (III/3)	4 kV
Rated voltage (III/2)	320 V
Rated surge voltage (III/2)	4 kV
Rated voltage (II/2)	630 V
Rated surge voltage (II/2)	4 kV

Connection data

Connection technology

Type	Standard
Connector system	COMBICON MSTB 2,5
Nominal cross section	2.5 mm ²
Type of contact	Socket

Interlock

Locking type	without
Mounting flange	without

Conductor connection

Connection method	Crimp connection
Conductor/PCB connection direction	0 °
Conductor cross section flexible	0.5 mm ² ... 2.5 mm ²
Conductor cross section AWG	20 ... 14

Material specifications

MSTBC 2,5/10-ST-5,08 - PCB connector

1808890

<https://www.phoenixcontact.com/in/products/1808890>

Material data - housing

Color (Housing)	green (6021)
Insulating material	PA
Insulating material group	I
CTI according to IEC 60112	600
Flammability rating according to UL 94	V0
Glow wire flammability index GWFI according to EN 60695-2-12	850
Glow wire ignition temperature GWIT according to EN 60695-2-13	775
Temperature for the ball pressure test according to EN 60695-10-2	125 °C

Material data – actuating element

Color ()	()
-----------	-----

Dimensions

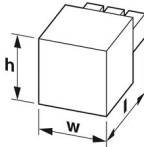
Dimensional drawing	
Pitch	5.08 mm
Width [w]	50.76 mm
Height [h]	10 mm
Length [l]	25 mm

Notes

Notes on operation	In accordance with IEC 61984, COMBICON connectors have no switching power (COC). During designated use, they must not be plugged in or disconnected when carrying voltage or under load.
--------------------	--

Environmental and real-life conditions

Ambient conditions

Ambient temperature (operation)	-40 °C ... 100 °C (dependent on the derating curve)
Ambient temperature (storage/transport)	-40 °C ... 70 °C
Relative humidity (storage/transport)	30 % ... 70 %
Ambient temperature (assembly)	-5 °C ... 100 °C

Electrical tests

Air clearances and creepage distances |

Specification	IEC 60664-1:2007-04
Insulating material group	I
Comparative tracking index (IEC 60112)	CTI 600
Rated insulation voltage (III/3)	320 V

MSTBC 2,5/10-ST-5,08 - PCB connector



1808890

<https://www.phoenixcontact.com/in/products/1808890>

Rated surge voltage (III/3)	4 kV
minimum clearance value - non-homogenous field (III/3)	3 mm
minimum creepage distance (III/3)	4 mm
Rated insulation voltage (III/2)	320 V
Rated surge voltage (III/2)	4 kV
minimum clearance value - non-homogenous field (III/2)	3 mm
minimum creepage distance (III/2)	3 mm
Rated insulation voltage (II/2)	630 V
Rated surge voltage (II/2)	4 kV
minimum clearance value - non-homogenous field (II/2)	3 mm
minimum creepage distance (II/2)	3.2 mm

Packaging specifications

Type of packaging	packed in cardboard
-------------------	---------------------

Drawings

Diagram

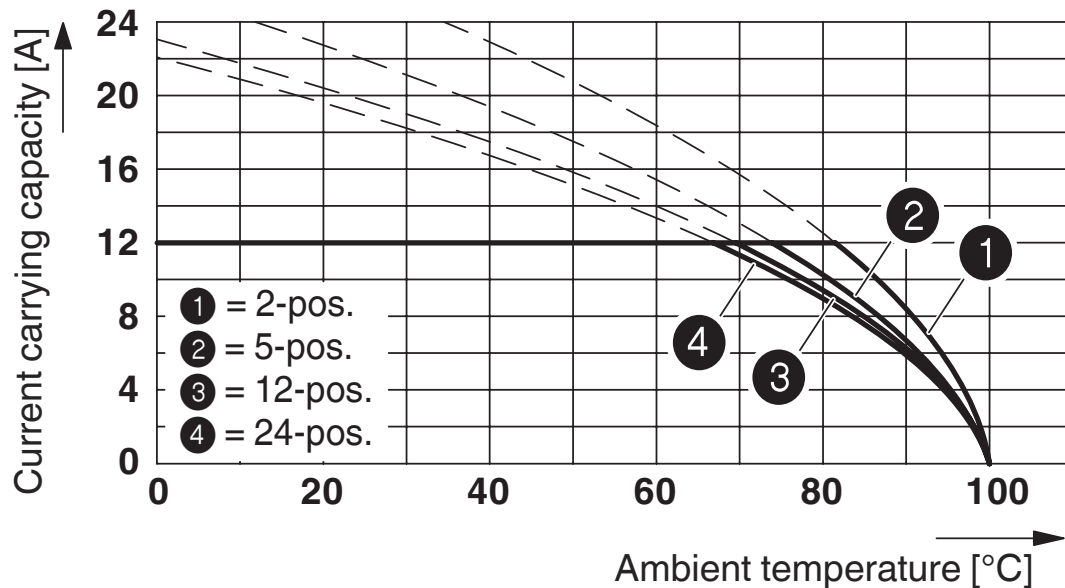

Type: MSTBC 2,5/...-ST-5,08 with MSTBA 2,5/...-G-5,08; contact: MSTBC-MT 1,5 - 2,5

Dimensional drawing

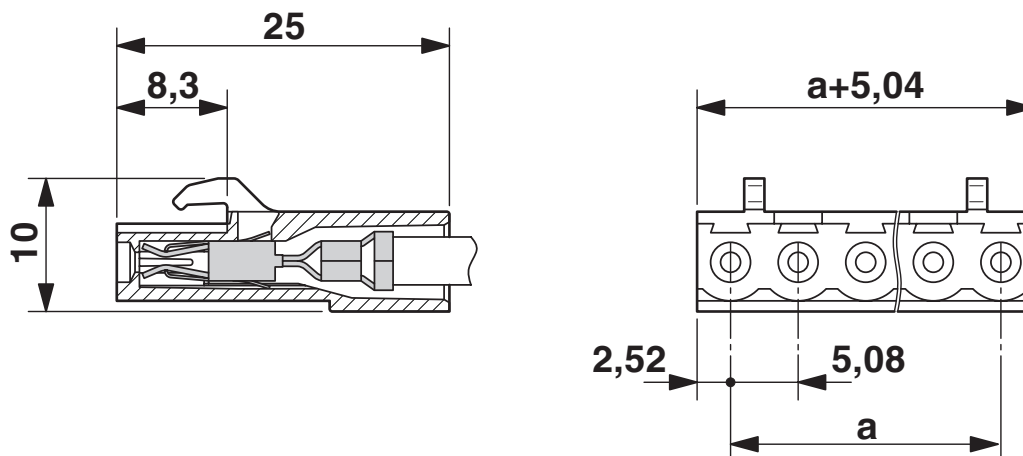

MSTBC 2,5/10-ST-5,08 - PCB connector



1808890

<https://www.phoenixcontact.com/in/products/1808890>

Approvals

 cULus Recognized Approval ID: E60425-19930525				
	Nominal Voltage U_N	Nominal Current I_N	Cross Section AWG	Cross Section mm^2
	300 V	10 A	20 - 14	-
	300 V	10 A	20 - 14	-

 CSA Approval ID: 13631				
	Nominal Voltage U_N	Nominal Current I_N	Cross Section AWG	Cross Section mm^2
	300 V	10 A	20 - 14	-

 IECEE CB Scheme Approval ID: DE1-60988-B1B2				
---	--	--	--	--

 EAC Approval ID: B.01687				
--	--	--	--	--

 VDE Zeichengenehmigung Approval ID: 40050648				
--	--	--	--	--

MSTBC 2,5/10-ST-5,08 - PCB connector



1808890

<https://www.phoenixcontact.com/in/products/1808890>

Classifications

ECLASS

ECLASS-11.0	27460202
ECLASS-12.0	27460202
ECLASS-13.0	27460202

ETIM

ETIM 8.0	EC002638
----------	----------

UNSPSC

UNSPSC 21.0	39121400
-------------	----------

MSTBC 2,5/10-ST-5,08 - PCB connector



1808890

<https://www.phoenixcontact.com/in/products/1808890>

Environmental Product Compliance

China RoHS	Environmentally friendly use period: unlimited = EFUP-e
	No hazardous substances above threshold values

MSTBC 2,5/10-ST-5,08 - PCB connector



1808890

<https://www.phoenixcontact.com/in/products/1808890>

Accessories

MSTBC-MT 0,5-1,0 - Crimp contact

3190564

<https://www.phoenixcontact.com/in/products/3190564>



Module female contact, is inserted into the plug housing MSTBC after crimping the conductor, for conductors from 0.5 to 1.0 mm²

MSTBC-MT 0,5-1,0 BA - Crimp contact

3190645

<https://www.phoenixcontact.com/in/products/3190645>



Module female contact, is inserted into the MSTBC connector shell after the conductor has been crimped, for conductors from 0.5 - 1.0 mm², ribbon contact

MSTBC 2,5/10-ST-5,08 - PCB connector

1808890

<https://www.phoenixcontact.com/in/products/1808890>

MSTBC-MT 1,5-2,5 - Crimp contact

3190551

<https://www.phoenixcontact.com/in/products/3190551>



Module female contact, is inserted into the plug housing MSTBC after crimping the conductor, for conductors from 1.5 to 2.5 mm²

MSTBC-MT 1,5-2,5 BA - Crimp contact

3190658

<https://www.phoenixcontact.com/in/products/3190658>



Module female contact, is inserted into the MSTBC connector shell after the conductor has been crimped, for conductors from 1.5 - 2.5 mm², ribbon contact

MSTBC 2,5/10-ST-5,08 - PCB connector

1808890

<https://www.phoenixcontact.com/in/products/1808890>

CRIMPFOX MT 2,5 - Crimping pliers

1204038

<https://www.phoenixcontact.com/in/products/1204038>



Crimping pliers, for crimping conductors to the module female contacts STG-MTN, crimp range: 0.5-2.5 mm², AWG: 20-14

SZS 0,4X2,5 VDE - Screwdriver

1205037

<https://www.phoenixcontact.com/in/products/1205037>



Screwdriver, slot-headed, VDE insulated, size: 0.4 x 2.5 x 80 mm, 2-component grip, with non-slip grip

MSTBC 2,5/10-ST-5,08 - PCB connector

1808890

<https://www.phoenixcontact.com/in/products/1808890>

SK 5,08/3,8:FORTL.ZAHLEN - Marker card

0804293

<https://www.phoenixcontact.com/in/products/0804293>



Marker card, white, labeled, horizontal: consecutive numbers 1 ... 10, 11 ... 20, etc. up to 91 ... (99)100, mounting type: adhesive, for terminal block width: 5.08 mm, lettering field size: 5.08 x 3.8 mm

CP-MSTB - Coding profile

1734634

<https://www.phoenixcontact.com/in/products/1734634>



Coding profile, is inserted into the slot on the plug or inverted header, red insulating material

MSTBC 2,5/10-ST-5,08 - PCB connector

1808890

<https://www.phoenixcontact.com/in/products/1808890>

MSTBC-MT 0,2-0,5 - Crimp contact

1879531

<https://www.phoenixcontact.com/in/products/1879531>



Module socket contact, is inserted into the plug housing MSTBC after crimping the conductor, for conductors from 0.2 to 0.5 mm²

MSTBC-MT 0,2-0,5 BAND - Crimp contact

1879544

<https://www.phoenixcontact.com/in/products/1879544>



Module socket contact, is inserted into the plug housing MSTBC after crimping the conductor, for conductors from 0.2 to 0.5 mm²

MSTBC 2,5/10-ST-5,08 - PCB connector

1808890

<https://www.phoenixcontact.com/in/products/1808890>

MSTBW 2,5/10-G-5,08 - PCB header

1735808

<https://www.phoenixcontact.com/in/products/1735808>

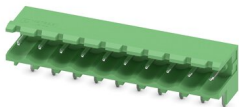

PCB headers, nominal cross section: 2.5 mm², color: green, nominal current: 12 A, rated voltage (III/2): 320 V, contact surface: Tin, type of contact: Pin, number of potentials: 10, number of rows: 1, number of positions: 10, number of connections: 10, product range: MSTBW 2,5/..-G, pitch: 5.08 mm, mounting: Wave soldering, pin layout: Linear pinning, solder pin [P]: 3.5 mm, number of solder pins per potential: 1, plug-in system: COMBICON MSTB 2,5, Pin connector pattern alignment: Standard, locking: without, mounting: without, type of packaging: packed in cardboard

MSTBVA 2,5/10-G-5,08 - PCB header

1755817

<https://www.phoenixcontact.com/in/products/1755817>

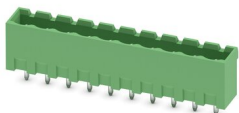

PCB headers, nominal cross section: 2.5 mm², color: green, nominal current: 12 A, rated voltage (III/2): 320 V, contact surface: Tin, type of contact: Pin, number of potentials: 10, number of rows: 1, number of positions: 10, number of connections: 10, product range: MSTBVA 2,5/..-G, pitch: 5.08 mm, mounting: Wave soldering, pin layout: Linear pinning, solder pin [P]: 3.9 mm, number of solder pins per potential: 1, plug-in system: COMBICON MSTB 2,5, Pin connector pattern alignment: Standard, locking: without, mounting: without, type of packaging: packed in cardboard

MSTBC 2,5/10-ST-5,08 - PCB connector



1808890

<https://www.phoenixcontact.com/in/products/1808890>

CCVA 2,5/10-G-5,08 P26THR - PCB header

1955934

<https://www.phoenixcontact.com/in/products/1955934>



PCB headers, nominal cross section: 2.5 mm², color: black, nominal current: 12 A, rated voltage (III/2): 320 V, contact surface: Tin, type of contact: Pin, number of potentials: 10, number of rows: 1, number of positions: 10, number of connections: 10, product range: CCVA 2,5/..-G, pitch: 5.08 mm, mounting: THR soldering, pin layout: Linear pinning, solder pin [P]: 2.6 mm, number of solder pins per potential: 1, plug-in system: COMBICON MSTB 2,5, Pin connector pattern alignment: Standard, locking: without, mounting: without, type of packaging: packed in cardboard, For user information and design recommendations for through-hole reflow technology, go to: Downloads

CCVA 2,5/10-G-5,08 P26THRR88 - PCB header

1956043

<https://www.phoenixcontact.com/in/products/1956043>



PCB headers, nominal cross section: 2.5 mm², color: black, nominal current: 12 A, rated voltage (III/2): 320 V, contact surface: Tin, type of contact: Pin, number of potentials: 10, number of rows: 1, number of positions: 10, number of connections: 10, product range: CCVA 2,5/..-G, pitch: 5.08 mm, mounting: THR soldering, pin layout: Linear pinning, solder pin [P]: 2.6 mm, number of solder pins per potential: 1, plug-in system: COMBICON MSTB 2,5, Pin connector pattern alignment: Standard, locking: without, mounting: without, type of packaging: 88 mm wide tape, For user information and design recommendations for through-hole reflow technology, go to: Downloads

Phoenix Contact 2023 © - all rights reserved
<https://www.phoenixcontact.com>

PHOENIX CONTACT (I) Pvt. Ltd.
A-58/2, Okhla Industrial Area, Phase - II, New Delhi-110 020

+91.1275.71420
info@phoenixcontact.co.in