

MKDS 1,5/ 4 - PCB terminal block



1715048

<https://www.phoenixcontact.com/in/products/1715048>

Please be informed that the data shown in this PDF document is generated from our Online Catalog. Please find the complete data in the user documentation. Our General Terms of Use for Downloads are valid.

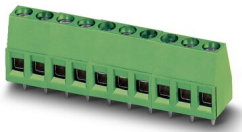

PCB terminal block, nominal current: 17.5 A, rated voltage (III/2): 400 V, nominal cross section: 1.5 mm², number of potentials: 4, number of rows: 1, number of positions per row: 4, product range: MKDS 1,5, pitch: 5 mm, connection method: Screw connection with tension sleeve, screw head form: L Slotted, mounting: Wave soldering, conductor/PCB connection direction: 0 °, color: green, Pin layout: Linear pinning, Solder pin [P]: 3.5 mm, number of solder pins per potential: 1, type of packaging: packed in cardboard. The article can be aligned to create different nos. of positions!

Your advantages

- Well-known connection principle allows worldwide use
- Low temperature rise, thanks to maximum contact force
- Allows connection of two conductors
- The latching on the side enables various numbers of positions to be combined

Commercial Data

| | |
|--------------------------------------|--------------------|
| Item number | 1715048 |
| Packing unit | 250 pc |
| Minimum order quantity | 250 pc |
| Sales Key | AAL |
| Product Key | AALFGF |
| Catalog Page | Page 95 (C-1-2013) |
| GTIN | 4017918024161 |
| Weight per Piece (including packing) | 5.64 g |
| Weight per Piece (excluding packing) | 5.495 g |
| Customs tariff number | 85369010 |
| Country of origin | DE |

Technical Data

Product properties

| | |
|---------------------------|----------------------------------|
| Type | PC terminal block can be aligned |
| Product line | COMBICON Terminals S |
| Product type | Printed circuit board terminal |
| Product family | MKDS 1,5 |
| Number of positions | 4 |
| Pitch | 5 mm |
| Number of connections | 4 |
| Number of rows | 1 |
| Number of potentials | 4 |
| Pin layout | Linear pinning |
| Solder pins per potential | 1 |

Electrical properties

| | |
|-----------------------------|--------|
| Nominal current I_N | 17.5 A |
| Nominal voltage U_N | 400 V |
| Degree of pollution | 3 |
| Rated voltage (III/3) | 250 V |
| Rated surge voltage (III/3) | 4 kV |
| Rated voltage (III/2) | 400 V |
| Rated surge voltage (III/2) | 4 kV |
| Rated voltage (II/2) | 630 V |
| Rated surge voltage (II/2) | 4 kV |

Connection data

Connection technology

| | |
|-----------------------|----------------------------------|
| Type | PC terminal block can be aligned |
| Nominal cross section | 1.5 mm ² |

Conductor connection

| | |
|---|---|
| Connection method | Screw connection with tension sleeve |
| Conductor cross section rigid | 0.14 mm ² ... 2.5 mm ² |
| Conductor cross section flexible | 0.14 mm ² ... 1.5 mm ² |
| Conductor cross section AWG | 26 ... 14 |
| Conductor cross section flexible, with ferrule without plastic sleeve | 0.25 mm ² ... 1.5 mm ² |
| Conductor cross section, flexible, with ferrule, with plastic sleeve | 0.25 mm ² ... 1.5 mm ² |
| 2 conductors with same cross section, solid | 0.14 mm ² ... 1 mm ² |
| 2 conductors with same cross section, flexible | 0.14 mm ² ... 0.75 mm ² |
| 2 conductors with same cross section, flexible, with ferrule without plastic sleeve | 0.25 mm ² ... 0.5 mm ² |
| 2 conductors with the same cross section, flexible, with TWIN | 0.5 mm ² ... 1 mm ² |

MKDS 1,5/ 4 - PCB terminal block



1715048

<https://www.phoenixcontact.com/in/products/1715048>

| | |
|-----------------------------|-------------------|
| ferrule with plastic sleeve | |
| Stripping length | 7 mm |
| Tightening torque | 0.5 Nm ... 0.6 Nm |

Mounting

| | |
|-----------------------|----------------|
| Mounting type | Wave soldering |
| Pin layout | Linear pinning |
| Drive form screw head | Slotted (L) |
| Drive form screw head | Slotted (L) |

Material specifications

Material data - contact

| | |
|--|--|
| Note | WEEE/RoHS-compliant, free of whiskers according to IEC 60068-2-82/JEDEC JESD 201 |
| Contact material | Cu alloy |
| Surface characteristics | Tin-plated |
| Metal surface terminal point (top layer) | Tin (4 - 8 µm Sn) |
| Metal surface soldering area (top layer) | Tin (4 - 8 µm Sn) |

Material data - housing

| | |
|---|--------------|
| Color (Housing) | green (6021) |
| Insulating material | PA |
| Insulating material group | I |
| CTI according to IEC 60112 | 600 |
| Flammability rating according to UL 94 | V0 |
| Glow wire flammability index GWFI according to EN 60695-2-12 | 850 |
| Glow wire ignition temperature GWIT according to EN 60695-2-13 | 775 |
| Temperature for the ball pressure test according to EN 60695-10-2 | 125 °C |

Material data – actuating element

| | |
|-----------|-----|
| Color () | () |
|-----------|-----|

Notes

| | |
|---------------------|--|
| Note on application | For safe conductor connection, always adhere to a defined tightening torque. Particularly in the case of PCB terminal blocks with two or three positions, the individual solder pin for each contact point cannot compensate for this. That is why the terminal blocks must be supported during conductor connection (held with one hand, support on the housing). |
|---------------------|--|

Dimensions

MKDS 1,5/ 4 - PCB terminal block

1715048

<https://www.phoenixcontact.com/in/products/1715048>

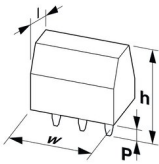
| | |
|-----------------------|--|
| Dimensional drawing |  |
| Pitch | 5 mm |
| Width [w] | 20 mm |
| Height [h] | 17.3 mm |
| Length [l] | 9.8 mm |
| Installed height | 13.8 mm |
| Solder pin length [P] | 3.5 mm |

| | |
|-------------|------|
| PCB design | |
| Pin spacing | 5 mm |

Mechanical tests

Test for conductor damage and slackening

| | |
|---------------|---------------------|
| Specification | IEC 60999-1:1999-11 |
| Result | Test passed |

Pull-out test

| | |
|---|--|
| Specification | IEC 60999-1:1999-11 |
| Conductor cross section/conductor type/tractive force setpoint/actual value | 0.14 mm ² / solid / > 10 N |
| | 0.14 mm ² / flexible / > 10 N |
| | 2.5 mm ² / solid / > 50 N |
| | 1.5 mm ² / flexible / > 40 N |

Electrical tests

Temperature-rise test

| | |
|-----------------------------------|--|
| Specification | IEC 60947-7-4:2019-01 |
| Requirement temperature-rise test | The sum of ambient temperature and temperature rise of the PCB terminal block shall not exceed the upper limiting temperature. |

Short-time withstand current

| | |
|---------------|-----------------------|
| Specification | IEC 60947-7-4:2019-01 |
|---------------|-----------------------|

Insulation resistance

| | |
|--|-----------------------|
| Specification | IEC 60512-3-1:2002-02 |
| Insulation resistance, neighboring positions | > 5 MΩ |

Air clearances and creepage distances |

| | |
|--|---|
| Specification | IEC 60947-1:2007-06 + A1:2010-12 + A2:2014-09 |
| Insulating material group | I |
| Comparative tracking index (IEC 60112) | CTI 600 |

MKDS 1,5/ 4 - PCB terminal block



1715048

<https://www.phoenixcontact.com/in/products/1715048>

| | |
|--|---|
| Rated insulation voltage (III/3) | 250 V |
| Rated surge voltage (III/3) | 4 kV |
| minimum clearance value - non-homogenous field (III/3) | 3 mm |
| minimum creepage distance (III/3) | 3.2 mm |
| Note on connection cross section | With connected conductor 2.5 mm ² (solid). |
| Rated insulation voltage (III/2) | 400 V |
| Rated surge voltage (III/2) | 4 kV |
| minimum clearance value - non-homogenous field (III/2) | 3 mm |
| minimum creepage distance (III/2) | 3 mm |
| Rated insulation voltage (II/2) | 630 V |
| Rated surge voltage (II/2) | 4 kV |
| minimum clearance value - non-homogenous field (II/2) | 3 mm |
| minimum creepage distance (II/2) | 3.2 mm |

Environmental and real-life conditions

Vibration test

| | |
|------------------------|-----------------------------|
| Specification | IEC 60068-2-6:2007-12 |
| Frequency | 10 - 150 - 10 Hz |
| Sweep speed | 1 octave/min |
| Amplitude | 0.35 mm (10 Hz ... 60.1 Hz) |
| Sweep speed | 5g (60.1 Hz ... 150 Hz) |
| Test duration per axis | 2.5 h |

Glow-wire test

| | |
|------------------|------------------------|
| Specification | IEC 60695-2-10:2013-04 |
| Temperature | 850 °C |
| Time of exposure | 5 s |

Aging

| | |
|---------------|-----------------------|
| Specification | IEC 60947-7-4:2019-01 |
|---------------|-----------------------|

Ambient conditions

| | |
|---|---|
| Ambient temperature (operation) | -40 °C ... 105 °C (Depending on the current carrying capacity/derating curve) |
| Ambient temperature (storage/transport) | -40 °C ... 70 °C |
| Relative humidity (storage/transport) | 30 % ... 70 % |
| Ambient temperature (assembly) | -5 °C ... 100 °C |

Packaging specifications

| | |
|-------------------|---------------------|
| Type of packaging | packed in cardboard |
|-------------------|---------------------|

MKDS 1,5/ 4 - PCB terminal block

1715048

<https://www.phoenixcontact.com/in/products/1715048>

Drawings

Dimensional drawing

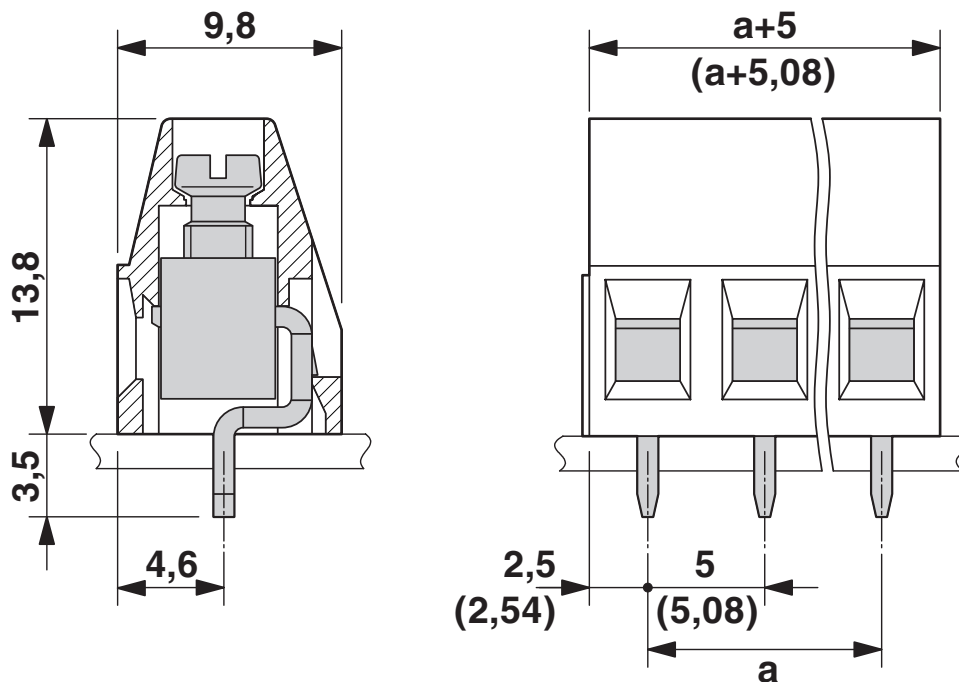

Diagram

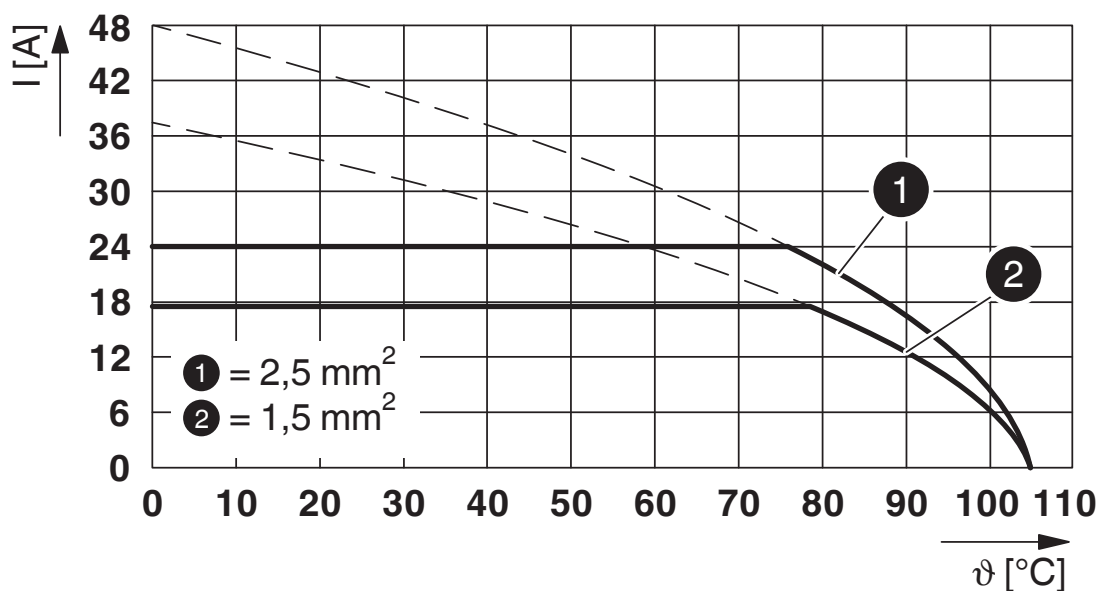

Type: MKDS 1,5/...

MKDS 1,5/ 4 - PCB terminal block

1715048

<https://www.phoenixcontact.com/in/products/1715048>



Drilling plan/solder pad geometry

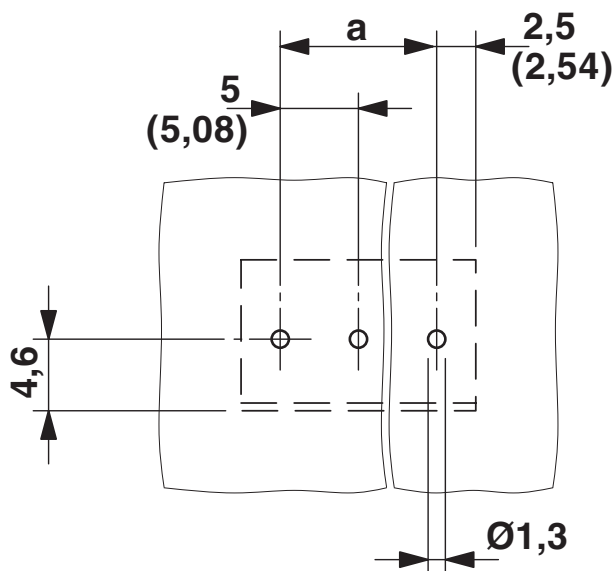

MKDS 1,5/ 4 - PCB terminal block



1715048

<https://www.phoenixcontact.com/in/products/1715048>

Approvals

|  CSA Approval ID: 13631 | | | | |
|--|-----------------------|-----------------------|-------------------|-----------------------------|
| | Nominal Voltage U_N | Nominal Current I_N | Cross Section AWG | Cross Section mm^2 |
| | 300 V | 10 A | 28 - 14 | - |
| | 300 V | 10 A | 28 - 14 | - |

|  EAC Approval ID: B.01687 | | | | |
|--|--|--|--|--|
|--|--|--|--|--|

|  cULus Recognized Approval ID: E60425-19770427 | | | | |
|---|-----------------------|-----------------------|-------------------|-----------------------------|
| | Nominal Voltage U_N | Nominal Current I_N | Cross Section AWG | Cross Section mm^2 |
| | 300 V | 15 A | 30 - 14 | - |
| | 300 V | 10 A | 30 - 14 | - |

|  DNV GL Approval ID: TAE00001EV | | | | |
|--|--|--|--|--|
|--|--|--|--|--|

|  IECEE CB Scheme Approval ID: DE1-66542 | | | | |
|--|-----------------------|-----------------------|-------------------|-----------------------------|
| | Nominal Voltage U_N | Nominal Current I_N | Cross Section AWG | Cross Section mm^2 |
| | 400 V | 24 A | - | 0.2 - 2.5 |

|  VDE Zeichengenehmigung Approval ID: 40055394 | | | | |
|--|-----------------------|-----------------------|-------------------|-----------------------------|
| | Nominal Voltage U_N | Nominal Current I_N | Cross Section AWG | Cross Section mm^2 |
| | 400 V | 24 A | - | 0.2 - 2.5 |

MKDS 1,5/ 4 - PCB terminal block



1715048

<https://www.phoenixcontact.com/in/products/1715048>

Classifications

ECLASS

| | |
|-------------|----------|
| ECLASS-11.0 | 27460101 |
| ECLASS-12.0 | 27460101 |
| ECLASS-13.0 | 27460101 |

ETIM

| | |
|----------|----------|
| ETIM 8.0 | EC002643 |
|----------|----------|

UNSPSC

| | |
|-------------|----------|
| UNSPSC 21.0 | 39121400 |
|-------------|----------|

MKDS 1,5/ 4 - PCB terminal block



1715048

<https://www.phoenixcontact.com/in/products/1715048>

Environmental Product Compliance

| | |
|------------|---|
| China RoHS | Environmentally friendly use period: unlimited = EFUP-e |
| | No hazardous substances above threshold values |

MKDS 1,5/ 4 - PCB terminal block

1715048

<https://www.phoenixcontact.com/in/products/1715048>

Accessories

 Note: Applying some accessories below might limit this product.

EBP 4- 5 - Insertion bridge

1733185

<https://www.phoenixcontact.com/in/products/1733185>



Insertion bridge for connectors with 5.0 mm or 5.08 mm pitch

 Max. current carrying capacity: 12 A

EBP 2- 5 - Insertion bridge

1733169

<https://www.phoenixcontact.com/in/products/1733169>



Insertion bridge for connectors with 5.0 mm or 5.08 mm pitch

 Max. current carrying capacity: 12 A

MKDS 1,5/ 4 - PCB terminal block

1715048

<https://www.phoenixcontact.com/in/products/1715048>



SZS 0,6X3,5 - Screwdriver

1205053

<https://www.phoenixcontact.com/in/products/1205053>



Actuation tool, for ST terminal blocks, insulated, also suitable for use as a bladed screwdriver, size: 0.6 x 3.5 x 100 mm, 2-component grip, with non-slip grip

SK 5/3,8:FORTL.ZAHLEN - Marker card

0804183

<https://www.phoenixcontact.com/in/products/0804183>



Marker card, white, labeled, horizontal: consecutive numbers 1 ... 10, 11 ... 20, etc. up to 91 ... (99)100, mounting type: adhesive, for terminal block width: 5 mm, lettering field size: 5 x 3.8 mm

MKDS 1,5/ 4 - PCB terminal block

1715048

<https://www.phoenixcontact.com/in/products/1715048>



RZ 1,25-MKDS 1,5 - Pitch spacer

1702048

<https://www.phoenixcontact.com/in/products/1702048>



Pitch spacer, for adjusting the pitches between MKDS and GMKDS terminal blocks in mixed rows, 1.25 mm thick

CRIMPFOX 6 - Crimping pliers

1212034

<https://www.phoenixcontact.com/in/products/1212034>



Crimping pliers, for ferrules without insulating collar according to DIN 46228 Part 1 and ferrules with insulating collar according to DIN 46228 Part 4, 0.25 mm² ... 6.0 mm², lateral entry, trapezoidal crimp

Phoenix Contact 2023 © - all rights reserved
<https://www.phoenixcontact.com>

PHOENIX CONTACT (I) Pvt. Ltd.
A-58/2, Okhla Industrial Area, Phase - II, New Delhi-110 020

+91.1275.71420
info@phoenixcontact.co.in