

# MC 1,5/11-G-3,81 - PCB header



1803361

<https://www.phoenixcontact.com/in/products/1803361>

Please be informed that the data shown in this PDF document is generated from our Online Catalog. Please find the complete data in the user documentation. Our General Terms of Use for Downloads are valid.

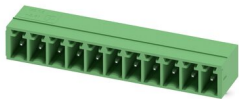

PCB headers, nominal cross section: 1.5 mm<sup>2</sup>, color: green, nominal current: 8 A, rated voltage (III/2): 160 V, contact surface: Tin, type of contact: Pin, number of potentials: 11, number of rows: 1, number of positions: 11, number of connections: 11, product range: MC 1,5/..-G, pitch: 3.81 mm, mounting: Wave soldering, pin layout: Linear pinning, solder pin [P]: 3.4 mm, number of solder pins per potential: 1, plug-in system: COMBICON MC 1,5, Pin connector pattern alignment: Standard, locking: without, mounting: without, type of packaging: packed in cardboard

## Your advantages

- Well-known mounting principle allows worldwide use
- Maximum flexibility when it comes to device design – one header for connectors with different connection technologies

## Commercial Data

|                                      |                     |
|--------------------------------------|---------------------|
| Item number                          | 1803361             |
| Packing unit                         | 50 pc               |
| Minimum order quantity               | 50 pc               |
| Sales Key                            | AAB                 |
| Product Key                          | AABSBA              |
| Catalog Page                         | Page 224 (C-1-2013) |
| GTIN                                 | 4017918045678       |
| Weight per Piece (including packing) | 3.046 g             |
| Weight per Piece (excluding packing) | 3.046 g             |
| Customs tariff number                | 85366930            |
| Country of origin                    | IN                  |

# MC 1,5/11-G-3,81 - PCB header



1803361

<https://www.phoenixcontact.com/in/products/1803361>

## Technical Data

### Product properties

|                           |                       |
|---------------------------|-----------------------|
| Type                      | Standard              |
| Product line              | COMBICON Connectors S |
| Product type              | PCB headers           |
| Product family            | MC 1,5/..-G           |
| Number of positions       | 11                    |
| Pitch                     | 3.81 mm               |
| Number of connections     | 11                    |
| Number of rows            | 1                     |
| Mounting flange           | without               |
| Number of potentials      | 11                    |
| Pin layout                | Linear pinning        |
| Solder pins per potential | 1                     |

### Electrical properties

|                             |                |
|-----------------------------|----------------|
| Nominal current $I_N$       | 8 A            |
| Nominal voltage $U_N$       | 160 V          |
| Degree of pollution         | 3              |
| Contact resistance          | 1.3 m $\Omega$ |
| Rated voltage (III/3)       | 160 V          |
| Rated surge voltage (III/3) | 2.5 kV         |
| Rated voltage (III/2)       | 160 V          |
| Rated surge voltage (III/2) | 2.5 kV         |
| Rated voltage (II/2)        | 250 V          |
| Rated surge voltage (II/2)  | 2.5 kV         |

### Mounting

|                       |                |
|-----------------------|----------------|
| Mounting type         | Wave soldering |
| Pin layout            | Linear pinning |
| Drive form screw head | Slotted        |
| Drive form screw head | Slotted        |

### Material specifications

#### Material data - contact

|   |  |
|---|--|
| Note                                      | WEEE/RoHS-compliant, free of whiskers according to IEC 60068-2-82/JEDEC JESD 201 |
| Contact material                          | Cu alloy   |
| Surface characteristics                   | Tin-plated   |
| Metal surface contact area (top layer)    | Tin (3 - 5 $\mu\text{m}$ Sn)   |
| Metal surface contact area (middle layer) | Nickel (1 - 3 $\mu\text{m}$ Ni)  |
| Metal surface soldering area (top layer)  | Tin (3 - 5 $\mu\text{m}$ Sn)   |

# MC 1,5/11-G-3,81 - PCB header

1803361

<https://www.phoenixcontact.com/in/products/1803361>

|   |                      |
|---|----------------------|
| Metal surface soldering area (middle layer) | Nickel (1 - 3 µm Ni) |
|---|----------------------|

## Material data - housing

|  |              |
|--|--------------|
| Color (Housing)                        | green (6021) |
| Insulating material                    | PBT          |
| Insulating material group              | IIIa         |
| CTI according to IEC 60112             | 225          |
| Flammability rating according to UL 94 | V0           |

## Material data – actuating element

|          |    |
|----------|----|
| Color () | () |
|----------|----|

## Dimensions

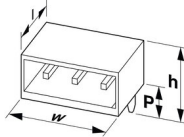
|                       |   |
|-----------------------|---|
| Dimensional drawing   |  |
| Pitch                 | 3.81 mm   |
| Width [w]             | 43.3 mm   |
| Height [h]            | 10.65 mm  |
| Length [l]            | 9.2 mm  |
| Installed height      | 7.25 mm   |
| Solder pin length [P] | 3.4 mm  |

## Mechanical tests

### Test for conductor damage and slackening

|               |                     |
|---------------|---------------------|
| Specification | IEC 60999-1:1999-11 |
| Result        | Test passed         |

### Pull-out test

|   |   |
|---|---|
| Specification   | IEC 60999-1:1999-11                     |
| Conductor cross section/conductor type/tractive force setpoint/actual value | 0.14 mm <sup>2</sup> / solid / > 7 N    |
|   | 0.14 mm <sup>2</sup> / flexible / > 7 N |
|   | 1.5 mm <sup>2</sup> / solid / > 40 N    |
|   | 1.5 mm <sup>2</sup> / flexible / > 40 N |

### Insertion and withdrawal forces

|                                     |             |
|-------------------------------------|-------------|
| Result                              | Test passed |
| No. of cycles                       | 25          |
| Insertion strength per pos. approx. | 6 N         |
| Withdraw strength per pos. approx.  | 4 N         |

### Torque test

|               |                     |
|---------------|---------------------|
| Specification | IEC 60999-1:1999-11 |
|---------------|---------------------|

# MC 1,5/11-G-3,81 - PCB header



1803361

<https://www.phoenixcontact.com/in/products/1803361>

## Contact holder in insert

|  |                        |
|--|------------------------|
| Specification                                  | IEC 60512-15-1:2008-05 |
| Contact holder in insert<br>Requirements >20 N | Test passed            |

## Resistance of inscriptions

|               |                        |
|---------------|------------------------|
| Specification | IEC 60068-2-70:1995-12 |
| Result        | Test passed            |

## Polarization and coding

|               |                        |
|---------------|------------------------|
| Specification | IEC 60512-13-5:2006-02 |
| Result        | Test passed            |

## Visual inspection

|               |                       |
|---------------|-----------------------|
| Specification | IEC 60512-1-1:2002-02 |
| Result        | Test passed           |

## Dimension check

|               |                       |
|---------------|-----------------------|
| Specification | IEC 60512-1-2:2002-02 |
| Result        | Test passed           |

## Electrical tests

### Thermal test | Test group C

|                            |                       |
|----------------------------|-----------------------|
| Specification              | IEC 60512-5-1:2002-02 |
| Tested number of positions | 20                    |

### Insulation resistance

|  |                       |
|--|-----------------------|
| Specification                                | IEC 60512-3-1:2002-02 |
| Insulation resistance, neighboring positions | > 5 MΩ                |

### Air clearances and creepage distances |

|  |                     |
|--|---------------------|
| Specification  | IEC 60664-1:2007-04 |
| Insulating material group                              | IIIa                |
| Comparative tracking index (IEC 60112)                 | CTI 225             |
| Rated insulation voltage (III/3)                       | 160 V               |
| Rated surge voltage (III/3)                            | 2.5 kV              |
| minimum clearance value - non-homogenous field (III/3) | 1.5 mm              |
| minimum creepage distance (III/3)                      | 2.5 mm              |
| Rated insulation voltage (III/2)                       | 160 V               |
| Rated surge voltage (III/2)                            | 2.5 kV              |
| minimum clearance value - non-homogenous field (III/2) | 1.5 mm              |
| minimum creepage distance (III/2)                      | 1.6 mm              |
| Rated insulation voltage (II/2)                        | 250 V               |
| Rated surge voltage (II/2)                             | 2.5 kV              |
| minimum clearance value - non-homogenous field (II/2)  | 1.5 mm              |
| minimum creepage distance (II/2)                       | 2.5 mm              |

# MC 1,5/11-G-3,81 - PCB header



1803361

<https://www.phoenixcontact.com/in/products/1803361>

## Environmental and real-life conditions

### Vibration test

|                        |                             |
|------------------------|-----------------------------|
| Specification          | IEC 60068-2-6:2007-12       |
| Frequency              | 10 - 150 - 10 Hz            |
| Sweep speed            | 1 octave/min                |
| Amplitude              | 0.35 mm (10 Hz ... 60.1 Hz) |
| Sweep speed            | 5g (60.1 Hz ... 150 Hz)     |
| Test duration per axis | 2.5 h                       |

### Durability test

|  |                       |
|--|-----------------------|
| Specification                                | IEC 60512-9-1:2010-03 |
| Impulse withstand voltage at sea level       | 2.95 kV               |
| Contact resistance $R_1$                     | 1.3 m $\Omega$        |
| Contact resistance $R_2$                     | 1.5 m $\Omega$        |
| Insertion/withdrawal cycles                  | 25                    |
| Insulation resistance, neighboring positions | > 5 M $\Omega$        |

### Climatic test

|                                   |   |
|-----------------------------------|---|
| Specification                     | ISO 6988:1985-02  |
| Corrosive stress                  | 0.2 dm <sup>3</sup> SO <sub>2</sub> on 300 dm <sup>3</sup> /40 °C/1 cycle |
| Thermal stress                    | 100 °C/168 h  |
| Power-frequency withstand voltage | 1.39 kV   |

### Ambient conditions

|   |   |
|---|---|
| Ambient temperature (operation)         | -40 °C ... 100 °C (dependent on the derating curve) |
| Ambient temperature (storage/transport) | -40 °C ... 70 °C                                    |
| Relative humidity (storage/transport)   | 30 % ... 70 %                                       |
| Ambient temperature (assembly)          | -5 °C ... 100 °C                                    |

## Packaging specifications

|                   |                     |
|-------------------|---------------------|
| Type of packaging | packed in cardboard |
|-------------------|---------------------|

# MC 1,5/11-G-3,81 - PCB header

1803361

<https://www.phoenixcontact.com/in/products/1803361>

## Drawings

Dimensional drawing

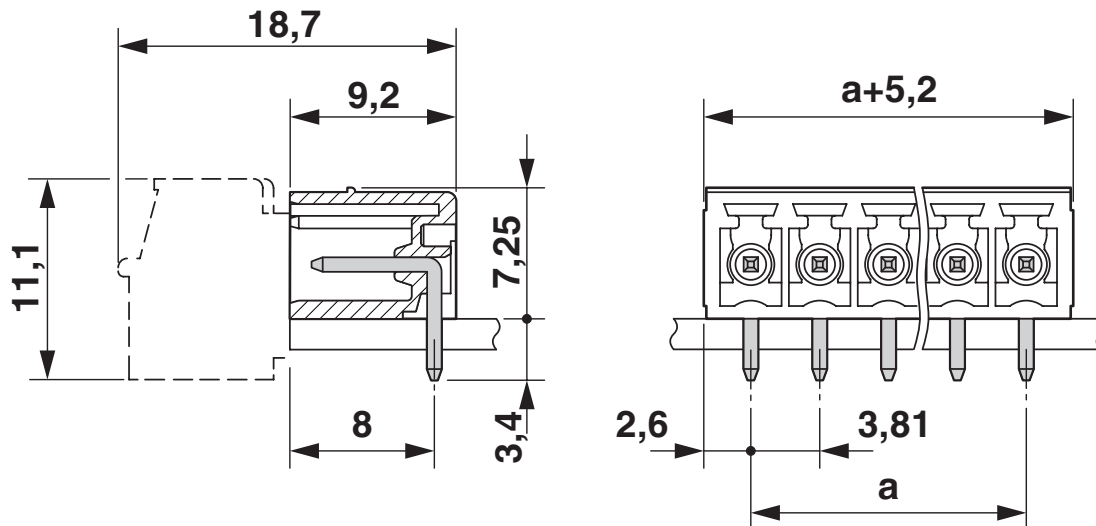

Diagram

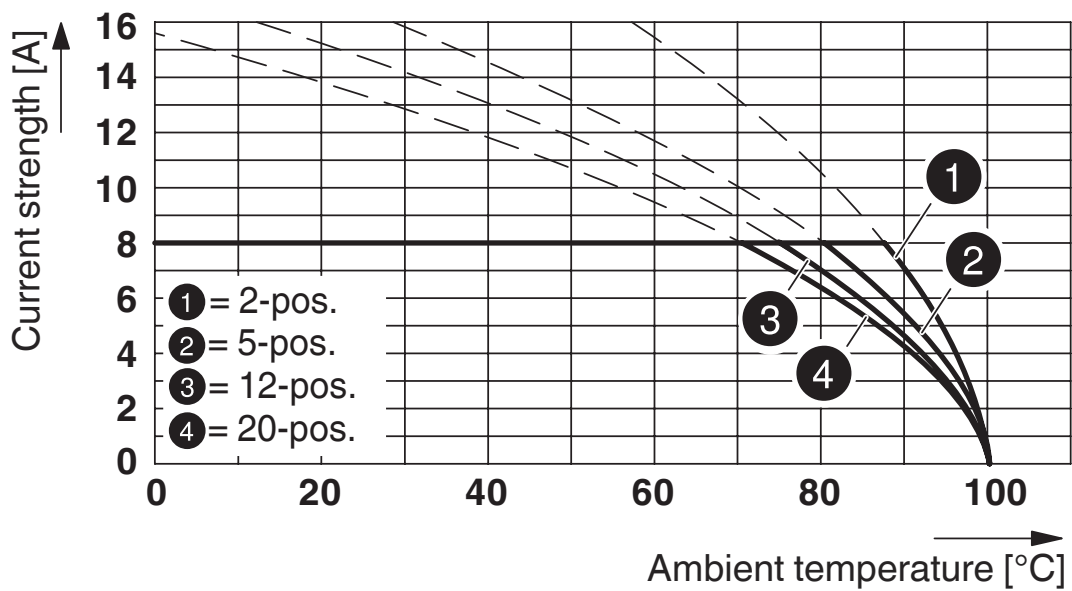

Type: MC 1,5/...-ST-3,81 with MC 1,5/...-G-3,81

# MC 1,5/11-G-3,81 - PCB header

1803361

<https://www.phoenixcontact.com/in/products/1803361>

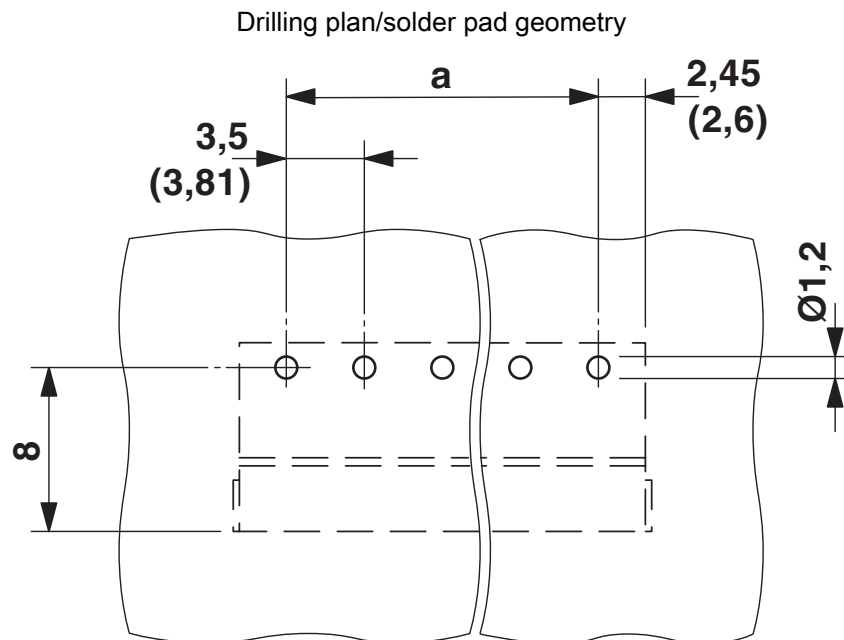

Diagram

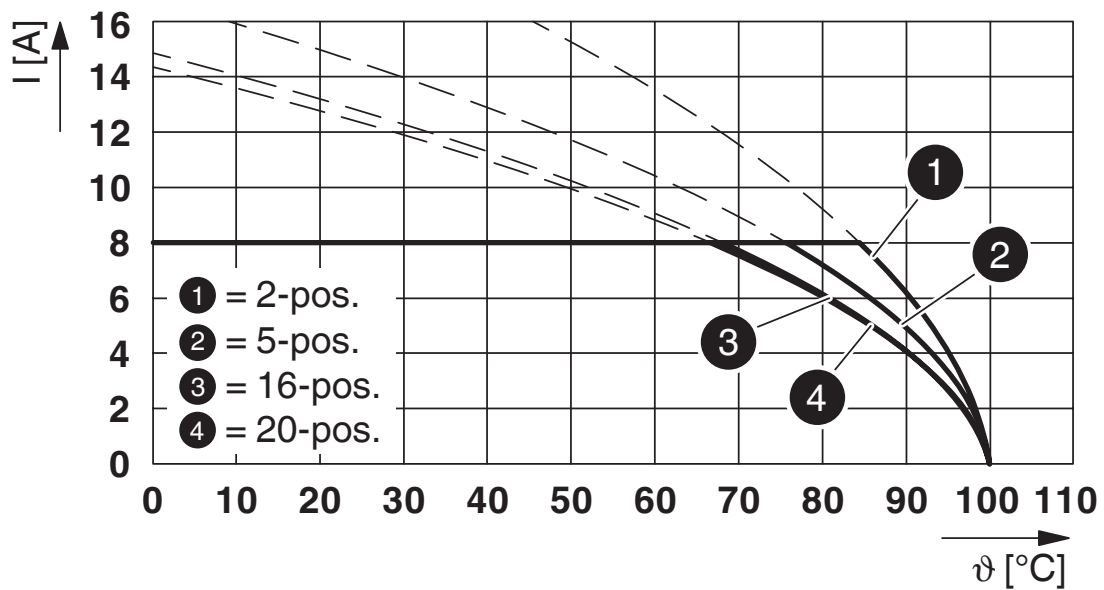

Type: FRONT-MC 1,5/...-ST-3,81 with MC 1,5/...-G-3,81

# MC 1,5/11-G-3,81 - PCB header



1803361

<https://www.phoenixcontact.com/in/products/1803361>

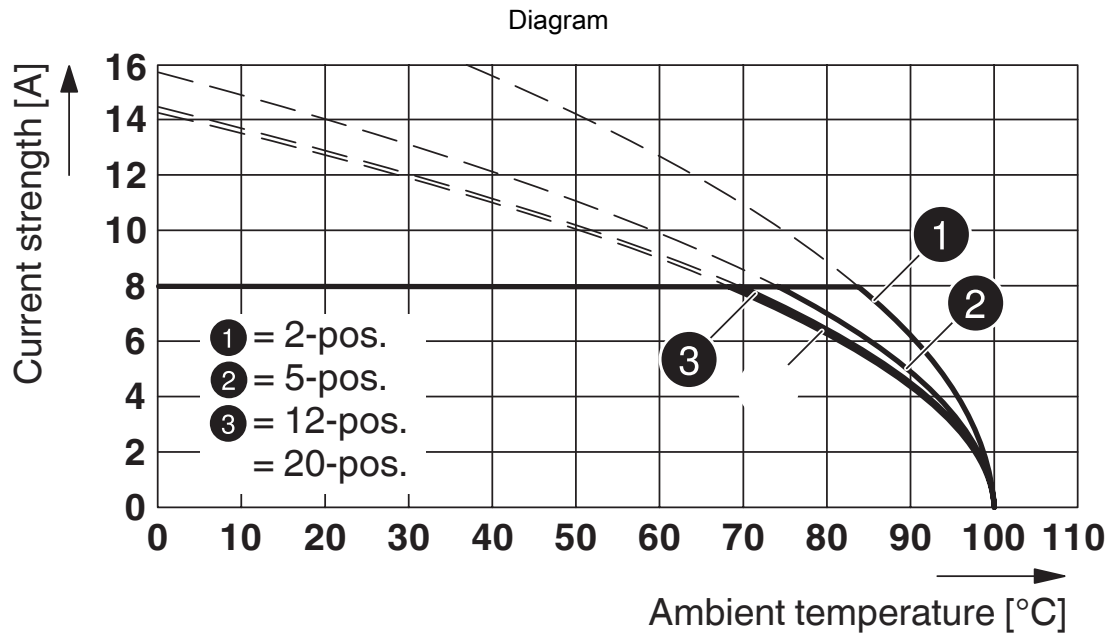

Type: FMC 1,5/...-ST-3,81 with MC 1,5/...-G-3,81

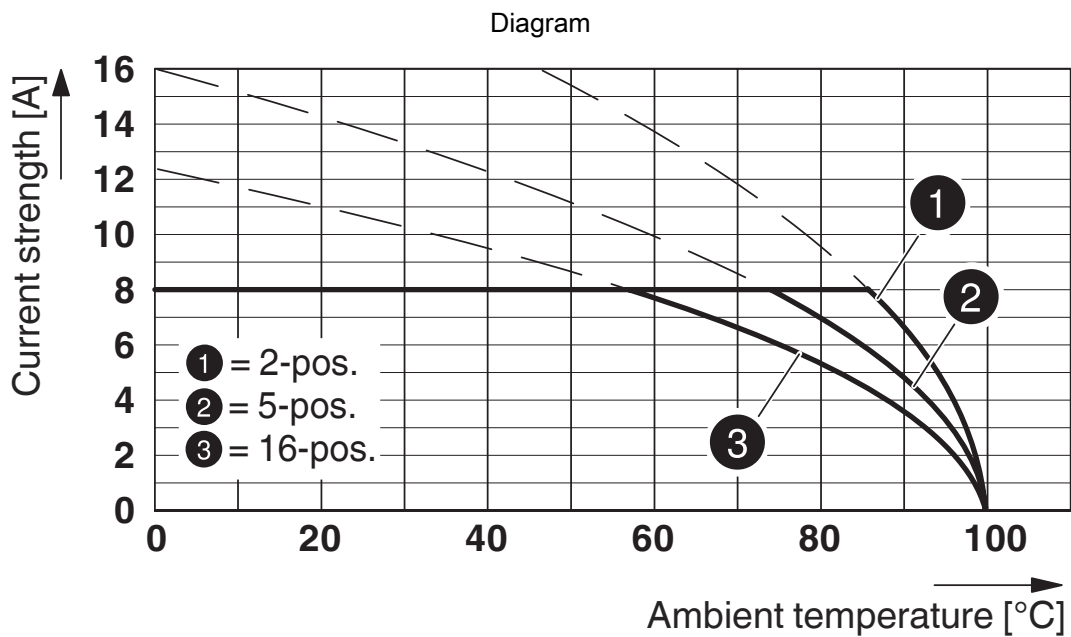

Type: IMC 1,5/...-G-3,81 with MC 1,5/...-G-3,81



# MC 1,5/11-G-3,81 - PCB header



1803361

<https://www.phoenixcontact.com/in/products/1803361>

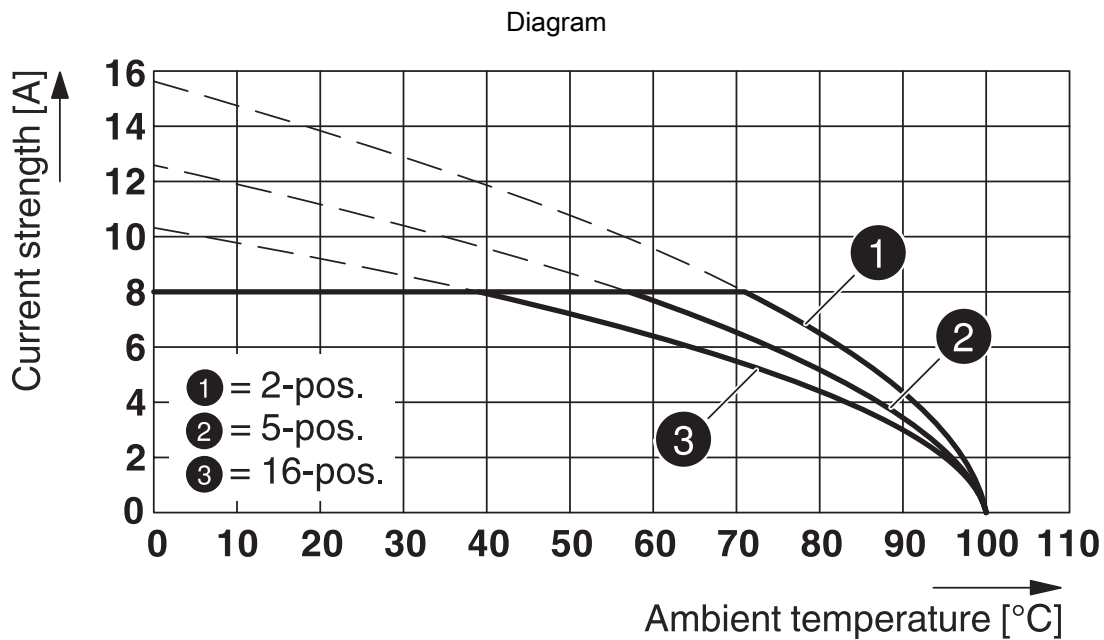

Type: MCVW 1,5/...-ST-3,81 with MC 1,5/...-G-3,81

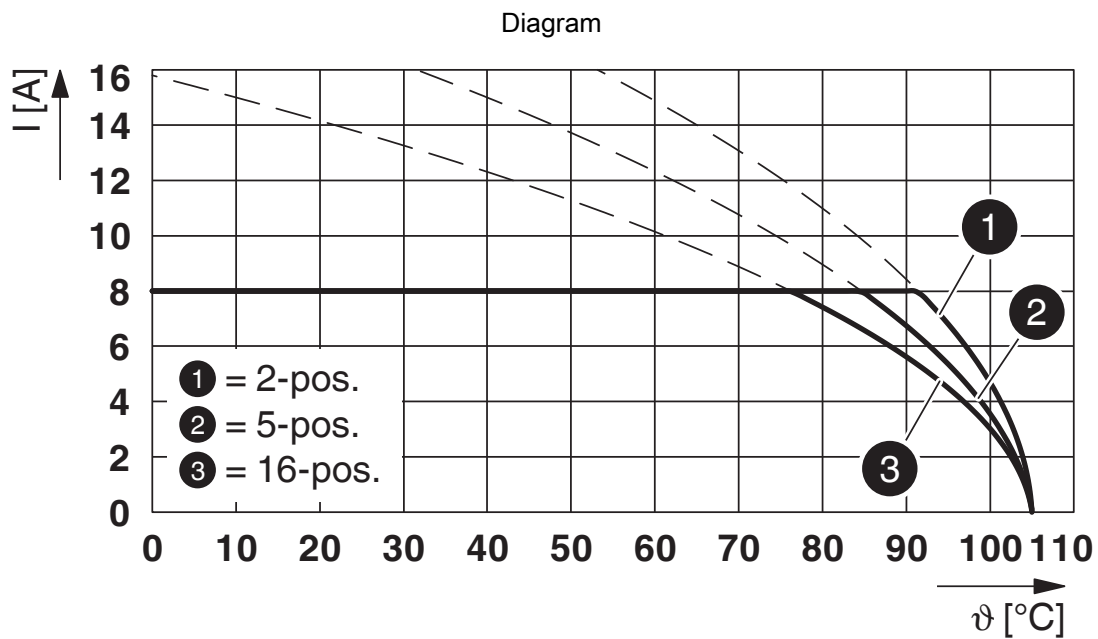

Type: LPC 1,5/...-ST-3,81 with MC 1,5/...-G-3,81

# MC 1,5/11-G-3,81 - PCB header



1803361

<https://www.phoenixcontact.com/in/products/1803361>

## Approvals

|  <b>CSA</b><br>Approval ID: 13631 |                       |                       |                   |                             |
|--|-----------------------|-----------------------|-------------------|-----------------------------|
|  | Nominal Voltage $U_N$ | Nominal Current $I_N$ | Cross Section AWG | Cross Section $\text{mm}^2$ |
|  | 300 V                 | 8 A                   | -                 | -                           |
|  | 300 V                 | 8 A                   | -                 | -                           |

|  <b>IECEE CB Scheme</b><br>Approval ID: DE1-60987-B1B2 |                       |                       |                   |                             |
|---|-----------------------|-----------------------|-------------------|-----------------------------|
|   | Nominal Voltage $U_N$ | Nominal Current $I_N$ | Cross Section AWG | Cross Section $\text{mm}^2$ |
|   | 160 V                 | 8 A                   | -                 | -                           |

|  <b>EAC</b><br>Approval ID: B.01687 |  |  |  |  |
|--|--|--|--|--|
|--|--|--|--|--|

|  <b>cULus Recognized</b><br>Approval ID: E60425-20110128 |                       |                       |                   |                             |
|---|-----------------------|-----------------------|-------------------|-----------------------------|
|   | Nominal Voltage $U_N$ | Nominal Current $I_N$ | Cross Section AWG | Cross Section $\text{mm}^2$ |
|   | 300 V                 | 8 A                   | -                 | -                           |
|   | 300 V                 | 8 A                   | -                 | -                           |

|  <b>VDE Zeichengenehmigung</b><br>Approval ID: 40011723 |                       |                       |                   |                             |
|--|-----------------------|-----------------------|-------------------|-----------------------------|
|  | Nominal Voltage $U_N$ | Nominal Current $I_N$ | Cross Section AWG | Cross Section $\text{mm}^2$ |
|  | 160 V                 | 8 A                   | -                 | -                           |

# MC 1,5/11-G-3,81 - PCB header

1803361

<https://www.phoenixcontact.com/in/products/1803361>



## Classifications

### ECLASS

|             |          |
|-------------|----------|
| ECLASS-11.0 | 27460201 |
| ECLASS-12.0 | 27460201 |
| ECLASS-13.0 | 27460201 |

### ETIM

|          |          |
|----------|----------|
| ETIM 8.0 | EC002637 |
|----------|----------|

### UNSPSC

|             |          |
|-------------|----------|
| UNSPSC 21.0 | 39121400 |
|-------------|----------|

# MC 1,5/11-G-3,81 - PCB header

1803361

<https://www.phoenixcontact.com/in/products/1803361>



## Environmental Product Compliance

|            |   |
|------------|---|
| China RoHS | Environmentally friendly use period: unlimited = EFUP-e |
|            | No hazardous substances above threshold values          |

# MC 1,5/11-G-3,81 - PCB header

1803361

<https://www.phoenixcontact.com/in/products/1803361>



## Accessories

### SK 3,81/2,8:FORTL.ZAHLEN - Marker card

0804109

<https://www.phoenixcontact.com/in/products/0804109>

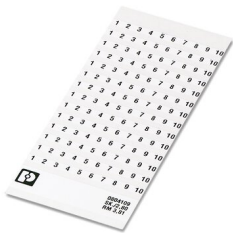

Marker card, white, labeled, horizontal: consecutive numbers 1 ... 10, 11 ... 20, etc. up to 91 ... (99)100, mounting type: adhesive, for terminal block width: 3.81 mm, lettering field size: 3.81 x 2.8 mm

---

### MC 1,5/10-LWL 1,5-3,81 - Fiber optic

1841174

<https://www.phoenixcontact.com/in/products/1841174>



MINI COMBICON fiber optics, 3.81 mm pitch, 10-pos., separable for other numbers of positions (minimum: 2-pos.), inserts into the back of the MC header, color: transparent, dimension a: 1.5 mm

## MC 1,5/11-G-3,81 - PCB header

1803361

<https://www.phoenixcontact.com/in/products/1803361>



## MC 1,5/10-LWL 2,3-3,81 - Fiber optic

1841190

<https://www.phoenixcontact.com/in/products/1841190>

MINI COMBICON fiber optics, 3.81 mm pitch, 10-pos., separable for other numbers of positions (minimum: 2-pos.), inserts into the back of the MC header, color: transparent, dimension a: 2.3 mm



---

## MC 1,5/10-LWL 4-3,81 - Fiber optic

1841213

<https://www.phoenixcontact.com/in/products/1841213>

MINI COMBICON fiber optics, 3.81 mm pitch, 10-pos., separable for other numbers of positions (minimum: 2-pos.), inserts into the back of the MC header, color: transparent, dimension a: 4 mm



# MC 1,5/11-G-3,81 - PCB header

1803361

<https://www.phoenixcontact.com/in/products/1803361>



## B-STIFT - Marker pen

1051993

<https://www.phoenixcontact.com/in/products/1051993>



Marker pen, for manual labeling of unprinted Zack strips, smear-proof and waterproof, line thickness 0.5 mm

---

## FMC 1,5/11-ST-3,81 - Printed-circuit board connector

1748066

<https://www.phoenixcontact.com/in/products/1748066>

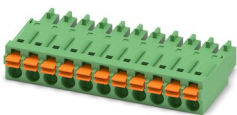

PCB connector, nominal cross section: 1.5 mm<sup>2</sup>, color: green, nominal current: 8 A, rated voltage (III/2): 160 V, contact surface: Tin, type of contact: Socket, number of potentials: 11, number of rows: 1, number of positions: 11, number of connections: 11, product range: FMC 1,5/..-ST, pitch: 3.81 mm, connection method: Push-in spring connection, conductor/PCB connection direction: 0 °, plug-in system: COMBICON MC 1,5, locking: without, mounting: without, type of packaging: packed in cardboard

## MC 1,5/11-G-3,81 - PCB header

1803361

<https://www.phoenixcontact.com/in/products/1803361>



## MC 1,5/11-ST-3,81 - PCB connector

1803662

<https://www.phoenixcontact.com/in/products/1803662>

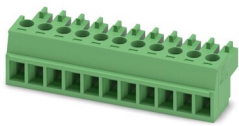

PCB connector, nominal cross section: 1.5 mm<sup>2</sup>, color: green, nominal current: 8 A, rated voltage (III/2): 160 V, contact surface: Tin, type of contact: Socket, number of potentials: 11, number of rows: 1, number of positions: 11, number of connections: 11, product range: MC 1,5/..-ST, pitch: 3.81 mm, connection method: Screw connection with tension sleeve, screw head form: L Slotted, conductor/PCB connection direction: 0 °, plug-in system: COMBICON MC 1,5, locking: without, mounting: without, type of packaging: packed in cardboard

---

## MCVW 1,5/11-ST-3,81 - PCB connector

1827062

<https://www.phoenixcontact.com/in/products/1827062>

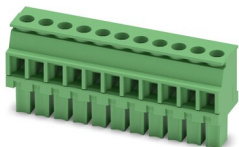

PCB connector, nominal cross section: 1.5 mm<sup>2</sup>, color: green, nominal current: 8 A, rated voltage (III/2): 160 V, contact surface: Tin, type of contact: Socket, number of potentials: 11, number of rows: 1, number of positions: 11, number of connections: 11, product range: MCVW 1,5/..-ST, pitch: 3.81 mm, connection method: Screw connection with tension sleeve, screw head form: L Slotted, conductor/PCB connection direction: -90 °, plug-in system: COMBICON MC 1,5, locking: without, mounting: without, type of packaging: packed in cardboard



# MC 1,5/11-G-3,81 - PCB header

1803361

<https://www.phoenixcontact.com/in/products/1803361>



## MCVR 1,5/11-ST-3,81 - PCB connector

1827211

<https://www.phoenixcontact.com/in/products/1827211>

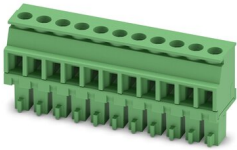

PCB connector, nominal cross section: 1.5 mm<sup>2</sup>, color: green, nominal current: 8 A, rated voltage (III/2): 160 V, contact surface: Tin, type of contact: Socket, number of potentials: 11, number of rows: 1, number of positions: 11, number of connections: 11, product range: MCVR 1,5/...-ST, pitch: 3.81 mm, connection method: Screw connection with tension sleeve, screw head form: L Slotted, conductor/PCB connection direction: 90 °, plug-in system: COMBICON MC 1,5, locking: without, mounting: without, type of packaging: packed in cardboard

---

## FRONT-MC 1,5/11-ST-3,81 - Printed-circuit board connector

1850754

<https://www.phoenixcontact.com/in/products/1850754>

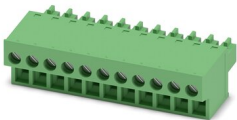

PCB connector, nominal cross section: 1.5 mm<sup>2</sup>, color: green, nominal current: 8 A, rated voltage (III/2): 160 V, contact surface: Tin, type of contact: Socket, number of potentials: 11, number of rows: 1, number of positions: 11, number of connections: 11, product range: FRONT-MC 1,5/...-ST, pitch: 3.81 mm, connection method: Front screw connection, screw head form: L Slotted, conductor/PCB connection direction: 0 °, plug-in system: COMBICON MC 1,5, locking: without, mounting: without, type of packaging: packed in cardboard

# MC 1,5/11-G-3,81 - PCB header

1803361

<https://www.phoenixcontact.com/in/products/1803361>



## FK-MCP 1,5/11-ST-3,81 - PCB connector

1851135

<https://www.phoenixcontact.com/in/products/1851135>

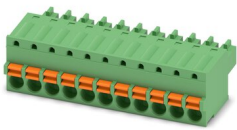

PCB connector, nominal cross section: 1.5 mm<sup>2</sup>, color: green, nominal current: 8 A, rated voltage (III/2): 160 V, contact surface: Tin, type of contact: Socket, number of potentials: 11, number of rows: 1, number of positions: 11, number of connections: 11, product range: FK-MCP 1,5/..-ST, pitch: 3.81 mm, connection method: Push-in spring connection, conductor/PCB connection direction: 0 °, plug-in system: COMBICON MC 1,5, locking: without, mounting: without, type of packaging: packed in cardboard

## MCC 1/11-STZ-3,81 - PCB connector

1852260

<https://www.phoenixcontact.com/in/products/1852260>



PCB connector, nominal cross section: 1 mm<sup>2</sup>, color: green, nominal current: 8 A, rated voltage (III/2): 160 V, type of contact: Socket, number of potentials: 11, number of rows: 1, number of positions: 11, number of connections: 11, product range: MCC 1/..-STZ, pitch: 3.81 mm, connection method: Crimp connection, conductor/PCB connection direction: 0 °, plug-in system: COMBICON MC 1,5, locking: without, mounting: without, type of packaging: packed in cardboard, Corresponding female crimp contacts with current [A] and conductor cross section range [mm<sup>2</sup>] data: 5A/MCC-MT 0,2-0,35 (1859988); 8A/MCC-MT 0,5-1,0 (1859991)

# MC 1,5/11-G-3,81 - PCB header

1803361

<https://www.phoenixcontact.com/in/products/1803361>



## QC 0,5/11-ST-3,81 - Printed-circuit board connector

1897487

<https://www.phoenixcontact.com/in/products/1897487>

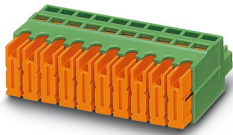

PCB connector, nominal cross section: 0.5 mm<sup>2</sup>, color: green, nominal current: 6 A, rated voltage (III/2): 200 V, contact surface: Tin, type of contact: Socket, number of potentials: 11, number of rows: 1, number of positions: 11, number of connections: 11, product range: QC 0,5/..-ST, pitch: 3.81 mm, connection method: Displacement connection, conductor/PCB connection direction: 0 °, plug-in system: COMBICON MC 1,5, locking: without, mounting: without, type of packaging: packed in cardboard

---

Phoenix Contact 2023 © - all rights reserved

<https://www.phoenixcontact.com>

PHOENIX CONTACT (I) Pvt. Ltd.

A-58/2, Okhla Industrial Area, Phase - II, New Delhi-110 020

+91.1275.71420

[info@phoenixcontact.co.in](mailto:info@phoenixcontact.co.in)