

# MCD 0,5/ 4-G1-2,5 - PCB header



1894820

<https://www.phoenixcontact.com/in/products/1894820>

Please be informed that the data shown in this PDF document is generated from our Online Catalog. Please find the complete data in the user documentation. Our General Terms of Use for Downloads are valid.



PCB headers, nominal cross section: 0.5 mm<sup>2</sup>, color: green, nominal current: 4 A, rated voltage (III/2): 160 V, contact surface: Tin, type of contact: Pin, number of potentials: 8, number of rows: 2, number of positions: 4, number of connections: 8, product range: MCD 0,5/..-G1, pitch: 2.5 mm, mounting: Wave soldering, pin layout: Linear pinning, solder pin [P]: 3.8 mm, number of solder pins per potential: 1, plug-in system: COMBICON FK-MC 0,5, Pin connector pattern alignment: Standard, locking: without, mounting: without, type of packaging: packed in cardboard

## Your advantages

- Well-known mounting principle allows worldwide use
- Conductor connection on several levels enables higher contact density

## Commercial Data

Item number	1894820
Packing unit	50 pc
Minimum order quantity	50 pc
Sales Key	AAA
Product Key	AAASDA
Catalog Page	Page 173 (C-1-2013)
GTIN	4017918162092
Weight per Piece (including packing)	3.873 g
Weight per Piece (excluding packing)	3.804 g
Customs tariff number	85366930
Country of origin	PL

# MCD 0,5/ 4-G1-2,5 - PCB header



1894820

<https://www.phoenixcontact.com/in/products/1894820>

## Technical Data

### Product properties

Type	Standard
Product line	COMBICON Connectors XS
Product type	PCB headers
Product family	MCD 0,5/...-G1
Number of positions	4
Pitch	2.5 mm
Number of connections	8
Number of rows	2
Mounting flange	without
Number of potentials	8
Pin layout	Linear pinning
Solder pins per potential	1

### Electrical properties

Nominal current $I_N$	4 A
Nominal voltage $U_N$	160 V
Degree of pollution	3
Contact resistance	3 mΩ
Rated voltage (III/3)	80 V
Rated surge voltage (III/3)	1.5 kV
Rated voltage (III/2)	160 V
Rated surge voltage (III/2)	2.5 kV
Rated voltage (II/2)	320 V
Rated surge voltage (II/2)	2.5 kV

### Mounting

Mounting type	Wave soldering
Pin layout	Linear pinning

### Material specifications

#### Material data - contact

Note	WEEE/RoHS-compliant, free of whiskers according to IEC 60068-2-82/JEDEC JESD 201
Contact material	Cu alloy
Surface characteristics	Tin-plated
Metal surface contact area (top layer)	Tin (3 - 5 μm Sn)
Metal surface contact area (middle layer)	Nickel (1 - 3 μm Ni)
Metal surface soldering area (top layer)	Tin (3 - 5 μm Sn)
Metal surface soldering area (middle layer)	Nickel (1 - 3 μm Ni)

#### Material data - housing

# MCD 0,5/ 4-G1-2,5 - PCB header

1894820

<https://www.phoenixcontact.com/in/products/1894820>

Color (Housing)	green (6021)
Insulating material	PA
Insulating material group	I
CTI according to IEC 60112	600
Flammability rating according to UL 94	V0
Glow wire flammability index GWFI according to EN 60695-2-12	850
Glow wire ignition temperature GWIT according to EN 60695-2-13	775
Temperature for the ball pressure test according to EN 60695-10-2	125 °C

## Material data – actuating element

Color ()	()
----------	----

## Dimensions

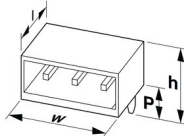
Dimensional drawing	
Pitch	2.5 mm
Width [w]	11.9 mm
Height [h]	25.7 mm
Length [l]	17.5 mm
Installed height	21.9 mm
Solder pin length [P]	3.8 mm

## Mechanical tests

### Test for conductor damage and slackening

Specification	IEC 60999-1:1999-11
Result	Test passed

### Repeated connection and disconnection

Specification	IEC 60999-1:1999-11
Result	Test passed

### Pull-out test

Specification	IEC 60999-1:1999-11
Conductor cross section/conductor type/tractive force setpoint/actual value	0.2 mm <sup>2</sup> / solid / > 10 N
	0.2 mm <sup>2</sup> / flexible / > 10 N
	0.5 mm <sup>2</sup> / solid / > 20 N
	0.5 mm <sup>2</sup> / flexible / > 20 N

### Insertion and withdrawal forces

Result	Test passed
--------	-------------

# MCD 0,5/ 4-G1-2,5 - PCB header



1894820

<https://www.phoenixcontact.com/in/products/1894820>

No. of cycles	25
Insertion strength per pos. approx.	7 N
Withdraw strength per pos. approx.	7 N

## Contact holder in insert

Specification	IEC 60512-15-1:2008-05
Contact holder in insert Requirements >20 N	Test passed

## Resistance of inscriptions

Specification	IEC 60068-2-70:1995-12
Result	Test passed

## Polarization and coding

Specification	IEC 60512-13-5:2006-02
Result	Test passed

## Visual inspection

Specification	IEC 60512-1-1:2002-02
Result	Test passed

## Dimension check

Specification	IEC 60512-1-2:2002-02
Result	Test passed

## Electrical tests

### Thermal test | Test group C

Specification	IEC 60512-5-1:2002-02
Tested number of positions	12

### Insulation resistance

Specification	IEC 60512-3-1:2002-02
Insulation resistance, neighboring positions	$10^{12} \Omega$

### Temperature cycles

Specification	IEC 60999-1:1999-11
Result	Test passed

### Air clearances and creepage distances |

Specification	IEC 60664-1:2007-04
Insulating material group	I
Comparative tracking index (IEC 60112)	CTI 600
Rated insulation voltage (III/3)	80 V
Rated surge voltage (III/3)	1.5 kV
minimum clearance value - non-homogenous field (III/3)	0.8 mm
minimum creepage distance (III/3)	1.7 mm
Rated insulation voltage (III/2)	160 V

# MCD 0,5/ 4-G1-2,5 - PCB header



1894820

<https://www.phoenixcontact.com/in/products/1894820>

Rated surge voltage (III/2)	2.5 kV
minimum clearance value - non-homogenous field (III/2)	1.5 mm
minimum creepage distance (III/2)	1.5 mm
Rated insulation voltage (II/2)	320 V
Rated surge voltage (II/2)	2.5 kV
minimum clearance value - non-homogenous field (II/2)	1.5 mm
minimum creepage distance (II/2)	1.6 mm

## Environmental and real-life conditions

### Vibration test

Specification	IEC 60068-2-6:2007-12
Frequency	10 - 150 - 10 Hz
Sweep speed	1 octave/min
Amplitude	0.35 mm (10 Hz ... 60.1 Hz)
Sweep speed	5g (60.1 Hz ... 150 Hz)
Test duration per axis	2.5 h

### Durability test

Specification	IEC 60512-9-1:2010-03
Impulse withstand voltage at sea level	1.75 kV
Contact resistance R <sub>1</sub>	3 mΩ
Contact resistance R <sub>2</sub>	4 mΩ
Insertion/withdrawal cycles	25

### Climatic test

Specification	ISO 6988:1985-02
Corrosive stress	0.2 dm <sup>3</sup> SO <sub>2</sub> on 300 dm <sup>3</sup> /40 °C/1 cycle
Thermal stress	100 °C/168 h
Power-frequency withstand voltage	0.84 kV

### Ambient conditions

Ambient temperature (operation)	-40 °C ... 100 °C (dependent on the derating curve)
Ambient temperature (storage/transport)	-40 °C ... 70 °C
Relative humidity (storage/transport)	30 % ... 70 %
Ambient temperature (assembly)	-5 °C ... 100 °C

## Packaging specifications

Type of packaging	packed in cardboard
-------------------	---------------------

# MCD 0,5/ 4-G1-2,5 - PCB header

1894820

<https://www.phoenixcontact.com/in/products/1894820>

## Drawings

Dimensional drawing

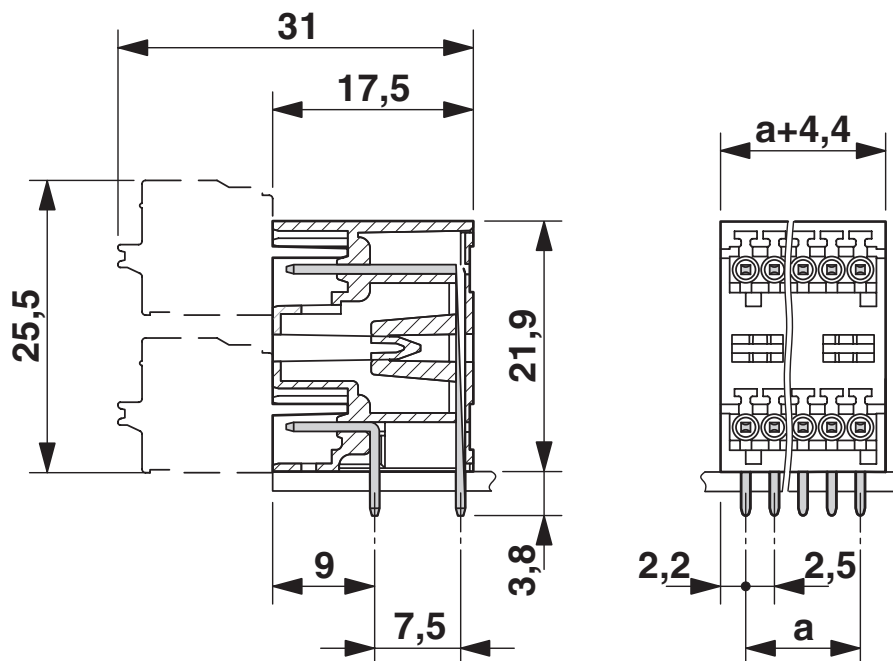

Diagram

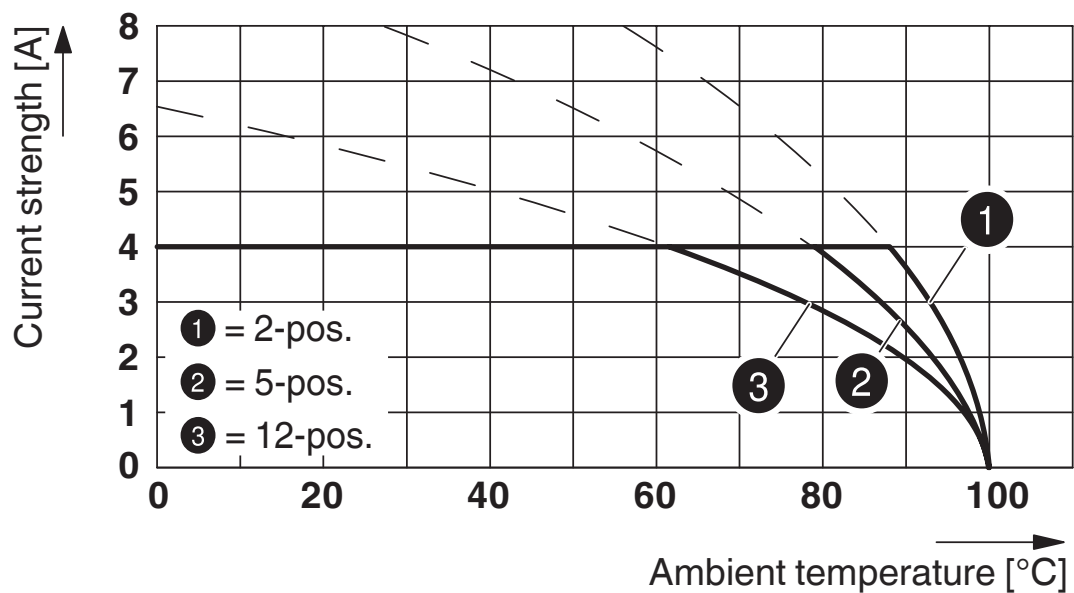

Type: FK-MC 0,5/...-ST-2,5 with MCD 0,5/...-G1-2,5

# MCD 0,5/ 4-G1-2,5 - PCB header

1894820

<https://www.phoenixcontact.com/in/products/1894820>



Drilling plan/solder pad geometry

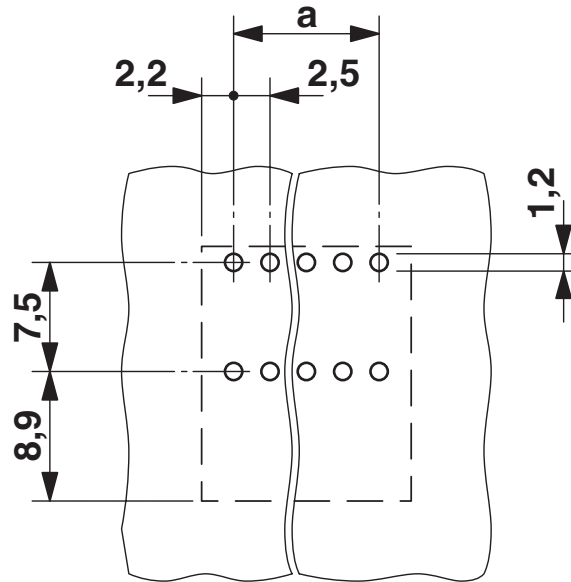

# MCD 0,5/ 4-G1-2,5 - PCB header



1894820

<https://www.phoenixcontact.com/in/products/1894820>

## Approvals

 <b>IECEE CB Scheme</b> Approval ID: DE1-56068-B1B2	Nominal Voltage $U_N$	Nominal Current $I_N$	Cross Section AWG	Cross Section $\text{mm}^2$
	80 V	4 A	-	-

 <b>EAC</b> Approval ID: B.01687
--

 <b>cULus Recognized</b> Approval ID: E60425-19990913	Nominal Voltage $U_N$	Nominal Current $I_N$	Cross Section AWG	Cross Section $\text{mm}^2$
	125 V	4 A	-	-

 <b>VDE Gutachten mit Fertigungsüberwachung</b> Approval ID: 40013394	Nominal Voltage $U_N$	Nominal Current $I_N$	Cross Section AWG	Cross Section $\text{mm}^2$
	80 V	4 A	-	-



# MCD 0,5/ 4-G1-2,5 - PCB header

1894820

<https://www.phoenixcontact.com/in/products/1894820>



## Classifications

### ECLASS

ECLASS-11.0	27460201
ECLASS-12.0	27460201
ECLASS-13.0	27460201

### ETIM

ETIM 8.0	EC002637
----------	----------

### UNSPSC

UNSPSC 21.0	39121400
-------------	----------

# MCD 0,5/ 4-G1-2,5 - PCB header

1894820

<https://www.phoenixcontact.com/in/products/1894820>



## Environmental Product Compliance

China RoHS	Environmentally friendly use period: unlimited = EFUP-e
	No hazardous substances above threshold values

# MCD 0,5/ 4-G1-2,5 - PCB header

1894820

<https://www.phoenixcontact.com/in/products/1894820>



## Accessories

### CP-MC 0,5 - Coding profile

1881435

<https://www.phoenixcontact.com/in/products/1881435>

Coding profile, is inserted into the groove in the header, red insulating material



---

### SK 2,54/2,8:FORTL.ZAHLEN - Marker card

0804853

<https://www.phoenixcontact.com/in/products/0804853>

Marker card, white, labeled, horizontal: consecutive numbers 1 ... 10, 11 ... 20, etc. up to 91 ... 99, mounting type: adhesive, for terminal block width: 2.54 mm, lettering field size: 2.54 x 2.8 mm

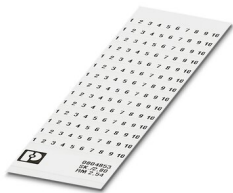

# MCD 0,5/ 4-G1-2,5 - PCB header

1894820

<https://www.phoenixcontact.com/in/products/1894820>



## FK-MC 0,5/ 4-ST-2,5 - PCB connector

1881341

<https://www.phoenixcontact.com/in/products/1881341>

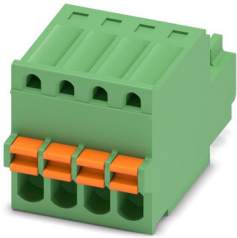

PCB connector, nominal cross section: 0.5 mm<sup>2</sup>, color: green, nominal current: 4 A, rated voltage (III/2): 160 V, contact surface: Tin, type of contact: Socket, number of potentials: 4, number of rows: 1, number of positions: 4, number of connections: 4, product range: FK-MC 0,5/...-ST, pitch: 2.5 mm, connection method: Push-in spring connection, conductor/PCB connection direction: 0 °, plug-in system: COMBICON FK-MC 0,5, locking: without, mounting: without, type of packaging: packed in cardboard

---

Phoenix Contact 2023 © - all rights reserved

<https://www.phoenixcontact.com>

PHOENIX CONTACT (I) Pvt. Ltd.

A-58/2, Okhla Industrial Area, Phase - II, New Delhi-110 020

+91.1275.71420

[info@phoenixcontact.co.in](mailto:info@phoenixcontact.co.in)