

# Product datasheet

Specifications



## Motor circuit breaker, TeSys GV2, 3P, 4-6.3 A, thermal magnetic, screw clamp terminals

GV2P10

### Main

Range	TeSys Deca
Product name	TeSys GV2 TeSys Deca
Product or component type	Motor circuit breaker
Device short name	GV2P
Device application	Motor protection
Trip unit technology	Thermal-magnetic

### Complementary

Poles description	3P
Network type	AC
Utilisation category	Category A conforming to IEC 60947-2 AC-3 conforming to IEC 60947-4-1
Network frequency	50/60 Hz conforming to IEC 60947-4-1
Fixing mode	35 mm symmetrical DIN rail: clipped Panel: screwed (with 2 x M4 screws)
Motor power kW	2.2 kW at 400/415 V AC 50/60 Hz 3 kW at 500 V AC 50/60 Hz 4 kW at 690 V AC 50/60 Hz
Breaking capacity	100 kA Icu at 230/240 V AC 50/60 Hz conforming to IEC 60947-2 100 kA Icu at 400/415 V AC 50/60 Hz conforming to IEC 60947-2 100 kA Icu at 440 V AC 50/60 Hz conforming to IEC 60947-2 100 kA Icu at 500 V AC 50/60 Hz conforming to IEC 60947-2 6 kA Icu at 690 V AC 50/60 Hz conforming to IEC 60947-2
[Ics] rated service short-circuit breaking capacity	100 % at 230/240 V AC 50/60 Hz conforming to IEC 60947-2 100 % at 400/415 V AC 50/60 Hz conforming to IEC 60947-2 100 % at 440 V AC 50/60 Hz conforming to IEC 60947-2 100 % at 500 V AC 50/60 Hz conforming to IEC 60947-2 100 % at 690 V AC 50/60 Hz conforming to IEC 60947-2
Control type	Rotary handle
[In] rated current	6.3 A
Thermal protection adjustment range	4...6.3 A conforming to IEC 60947-4-1
Magnetic tripping current	78 A
[Ith] conventional free air thermal current	6.3 A conforming to IEC 60947-4-1
[Ue] rated operational voltage	690 V AC 50/60 Hz conforming to IEC 60947-2

<b>[Ui] rated insulation voltage</b>	690 V AC 50/60 Hz conforming to IEC 60947-2
<b>[Uimp] rated impulse withstand voltage</b>	6 kV conforming to IEC 60947-2
<b>Phase failure sensitivity</b>	Yes conforming to IEC 60947-4-1
<b>Suitability for isolation</b>	Yes conforming to IEC 60947-1 § 7-1-6
<b>Power dissipation per pole</b>	2.5 W
<b>Mechanical durability</b>	100000 cycles
<b>Electrical durability</b>	100000 cycles for AC-3 at 415 V In
<b>Rated duty</b>	Continuous conforming to IEC 60947-4-1
<b>Tightening torque</b>	1.7 N.m - on screw clamp terminal
<b>Width</b>	45 mm
<b>Height</b>	89 mm
<b>Depth</b>	97 mm
<b>Colour</b>	Dark grey

## Environment

<b>Standards</b>	EN/IEC 60947-2 EN/IEC 60947-4-1
<b>Product certifications</b>	CCC UL CSA EAC ATEX LROS (Lloyds register of shipping) BV RINA DNV-GL UKCA
<b>IK degree of protection</b>	IK04
<b>IP degree of protection</b>	IP20 conforming to IEC 60529
<b>Climatic withstand</b>	conforming to IACS E10
<b>Ambient air temperature for storage</b>	-40...80 °C
<b>Fire resistance</b>	960 °C conforming to IEC 60695-2-11
<b>Ambient air temperature for operation</b>	-20...60 °C
<b>Mechanical robustness</b>	Shocks: 30 Gn for 11 ms Vibrations: 5 Gn, 5...150 Hz
<b>Operating altitude</b>	2000 m

## Packing Units

<b>Unit Type of Package 1</b>	PCE
<b>Number of Units in Package 1</b>	1
<b>Package 1 Height</b>	4.800 cm
<b>Package 1 Width</b>	9.500 cm
<b>Package 1 Length</b>	10.000 cm
<b>Package 1 Weight</b>	324.000 g
<b>Unit Type of Package 2</b>	S02
<b>Number of Units in Package 2</b>	20
<b>Package 2 Height</b>	15.000 cm
<b>Package 2 Width</b>	30.000 cm

<b>Package 2 Length</b>	40.000 cm
<b>Package 2 Weight</b>	6.758 kg
<b>Unit Type of Package 3</b>	P06
<b>Number of Units in Package 3</b>	320
<b>Package 3 Height</b>	75.000 cm
<b>Package 3 Width</b>	60.000 cm
<b>Package 3 Length</b>	80.000 cm
<b>Package 3 Weight</b>	114.608 kg

## Offer Sustainability

<b>REACH Regulation</b>	<a href="#">REACH Declaration</a>
<b>EU RoHS Directive</b>	Compliant <a href="#">EU RoHS Declaration</a>
<b>Mercury free</b>	Yes
<b>China RoHS Regulation</b>	<a href="#">China RoHS declaration</a> Product out of China RoHS scope. Substance declaration for your information
<b>RoHS exemption information</b>	<a href="#">Yes</a>
<b>WEEE</b>	The product must be disposed on European Union markets following specific waste collection and never end up in rubbish bins

## Contractual warranty

<b>Warranty</b>	18 months
-----------------	-----------

**Thermal-Magnetic Tripping Curves for GV2ME and GV2P**  
Average Operating Times at 20 °C Related to Multiples of the Setting Current

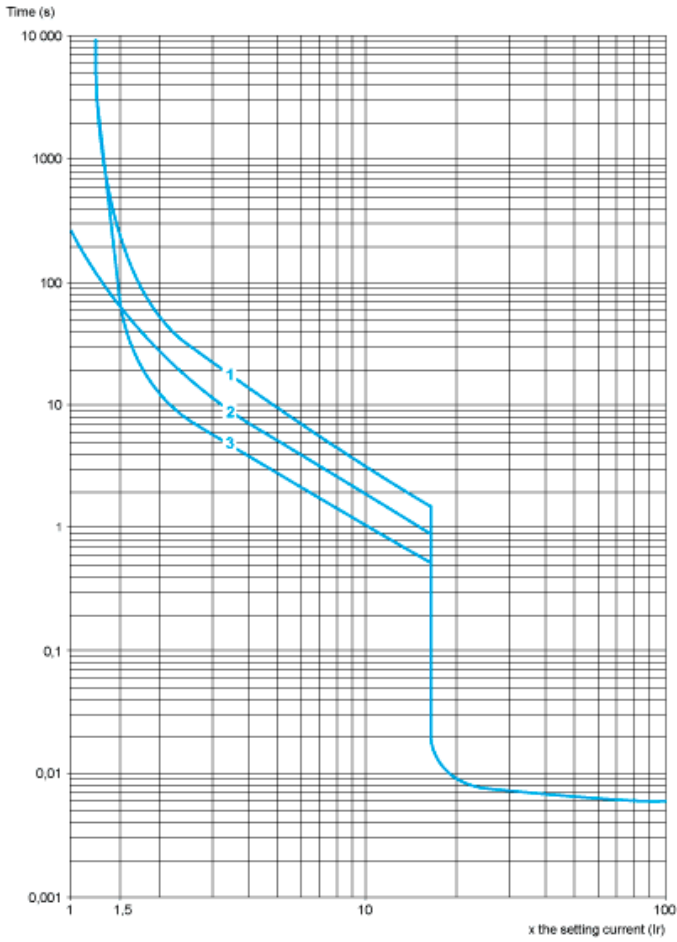

- 1 3 poles from cold state
- 2 2 poles from cold state
- 3 3 poles from hot state

**Current Limitation on Short-Circuit for GV2ME and GV2P (3-Phase 400/415 V)**

**Dynamic Stress**

$I_{peak} = f(\text{prospective } I_{sc}) \text{ at } 1.05 U_e = 435 \text{ V}$

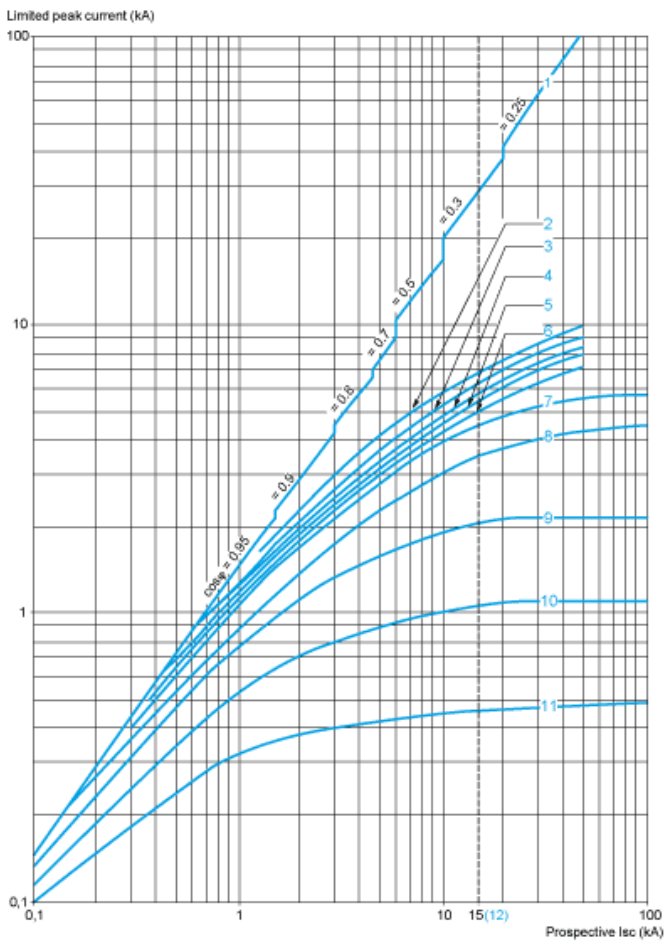

- 1 Maximum peak current
- 2 24-32 A
- 3 20-25 A
- 4 17-23 A
- 5 13-18 A
- 6 9-14 A
- 7 6-10 A
- 8 4-6.3 A
- 9 2.5-4 A
- 10 1.6-2.5 A
- 11 1-1.6 A
- 12 Limit of rated ultimate breaking capacity on short-circuit of GV2ME (14, 18, 23, and 25 A ratings).

### Thermal Limit on Short-Circuit for GV2P

Thermal Limit in  $\text{kA}^2\text{s}$  in the Magnetic Operating Zone

Sum of  $I^2dt = f(\text{prospective Isc})$  at  $1.05 U_e = 435 \text{ V}$

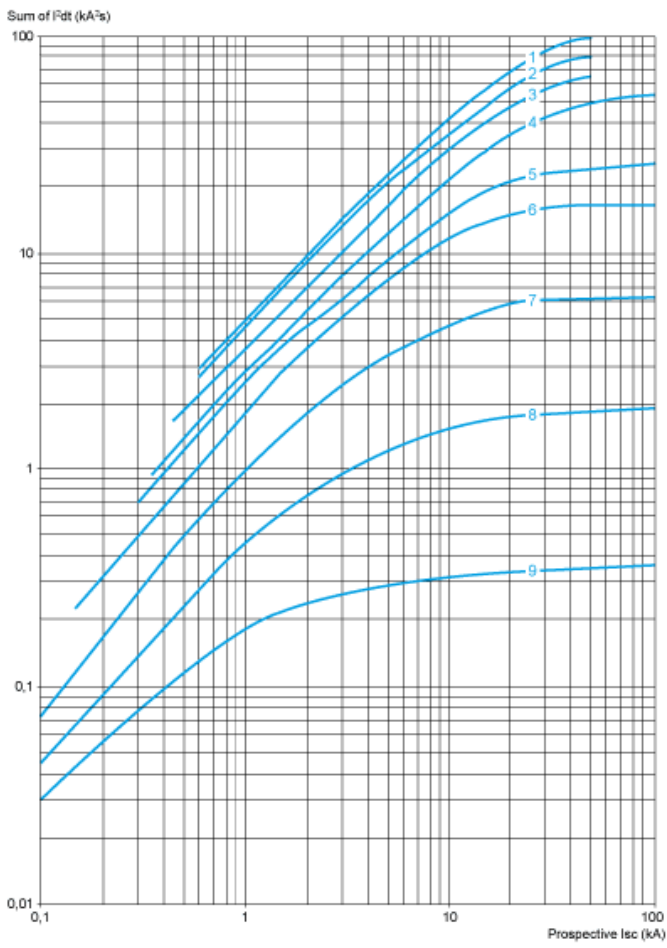

- 1 24-32 A
- 2 20-25 A
- 3 17-23 A
- 4 13-18 A
- 5 9-14 A
- 6 6-10 A
- 7 4-6.3 A
- 8 2.5-4 A
- 9 1.6-2.5 A
- 10 1-1.6 A

**GV2P**

On rail AM1 DE200, ED200 (35 x 15)

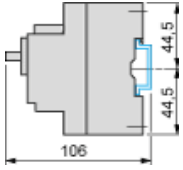

Panel mounted

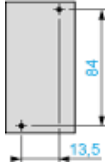

On pre-slotted plate AM1 PA

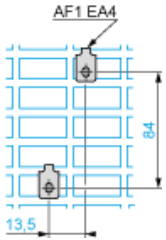

Adapter plate GK2AF01

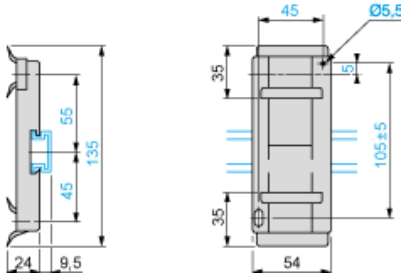

Combination GV2P + TeSys d contactor

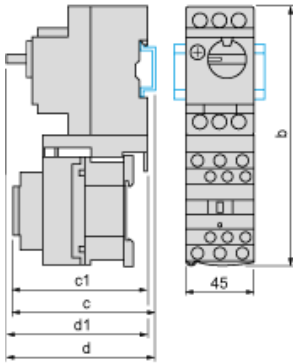

GV2P +	LC1D09...D18	LC1D25 and D32
b	176.4	186.8
c1	100.1	106.4
c	105.6	111.9
d1	95	95
d	100.5	100.5

**Mounting**

Mounting of External Operator GV2APN01, GV2APN02 or GV2APN04 for Motor Circuit Breakers GV2P

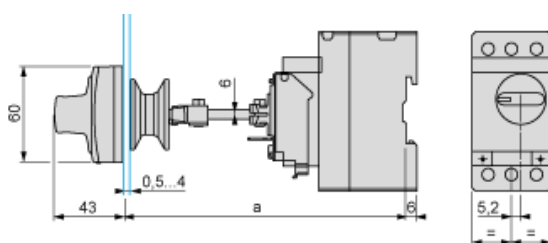

Door cut-out

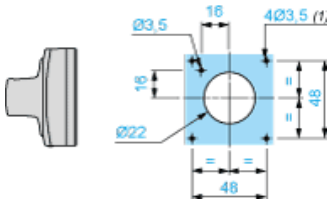

(1) For IP65 only.

Mounting of External Operator GVAPH02 for Motor Circuit Breakers GV2P

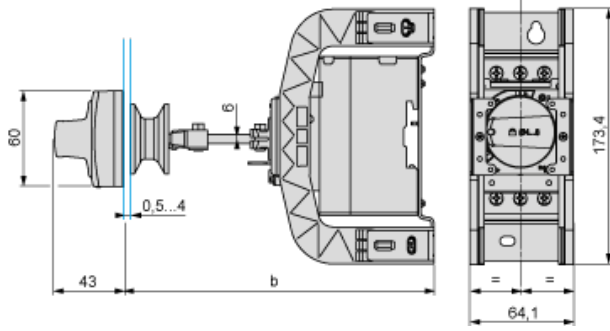

	a		b	
	Minimum	Maximum	Minimum	Maximum
GV2APN..	140	250	–	–
GV2APN.. + GVAPH02	–	–	151	250
GV2APN.. + GVAPK11	250	434	–	–
GV2APN.. + GVAPH02 + GVAPK11	–	–	250	445

Door cut-out

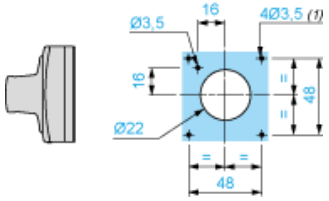

(1) For IP65 only.



**GV2P••**

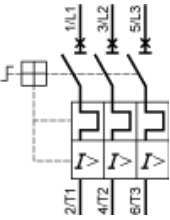

**Recommended replacement(s)**