

ICC 2,5/ 4-STZ-5,08 - PCB connector



1823862

<https://www.phoenixcontact.com/in/products/1823862>

Please be informed that the data shown in this PDF document is generated from our Online Catalog. Please find the complete data in the user documentation. Our General Terms of Use for Downloads are valid.



PCB connector, nominal cross section: 2.5 mm², color: green, nominal current: 12 A, rated voltage (III/2): 320 V, type of contact: Pin, number of potentials: 4, number of rows: 1, number of positions: 4, number of connections: 4, product range: ICC 2,5/...-STZ, pitch: 5.08 mm, connection method: Crimp connection, conductor/PCB connection direction: 0 °, locking clip: - without locking clip, plug-in system: COMBICON MSTB 2,5, locking: Snap-in locking, mounting: Engagement nose, type of packaging: packed in cardboard, Corresponding male crimp contacts with current [A] and conductor cross section range [mm²] data: 10A/ICC-MT 0,5-1,0 (3190577); 10A/ICC-MT 0,5-1,0 BA (3190603); 12A/ICC-MT 1,5-2,5 (3190580); 12A/ICC-MT 1,5-2,5 BA (3190593). BA = Bandkontakte

Your advantages

- Inexpensive connection of large quantities of pre-assembled conductors
- Pull-out aid facilitates handling and allows the tensile force to be reduced at the contact point
- Can be combined with the MSTB 2,5 range
- Intuitive locking mechanism prevents accidental disconnection

Commercial Data

Item number	1823862
Packing unit	50 pc
Minimum order quantity	50 pc
Sales Key	AAC
Product Key	AACCBA
Catalog Page	Page 296 (C-1-2013)
GTIN	4017918048716
Weight per Piece (including packing)	3.03 g
Weight per Piece (excluding packing)	2.874 g
Customs tariff number	85389099
Country of origin	PL

ICC 2,5/ 4-STZ-5,08 - PCB connector



1823862

<https://www.phoenixcontact.com/in/products/1823862>

Technical Data

Product properties

Type	Inverted
Product line	COMBICON Connectors M
Product type	PCB plug
Product family	ICC 2,5/...STZ
Number of positions	4
Pitch	5.08 mm
Number of connections	4
Number of rows	1
Mounting flange	without
Number of potentials	4

Electrical properties

Nominal current I_N	12 A
Nominal voltage U_N	320 V
Degree of pollution	3
Rated voltage (III/3)	250 V
Rated surge voltage (III/3)	4 kV
Rated voltage (III/2)	320 V
Rated surge voltage (III/2)	4 kV
Rated voltage (II/2)	630 V
Rated surge voltage (II/2)	4 kV

Connection data

Connection technology

Type	Inverted
Connector system	COMBICON MSTB 2,5
Nominal cross section	2.5 mm ²
Type of contact	Pin

Interlock

Locking type	Snap-in locking
Mounting flange	Engagement nose

Conductor connection

Connection method	Crimp connection
Conductor/PCB connection direction	0 °
Conductor cross section flexible	0.5 mm ² ... 2.5 mm ²
Conductor cross section AWG	20 ... 14

Material specifications

ICC 2,5/ 4-STZ-5,08 - PCB connector

1823862

<https://www.phoenixcontact.com/in/products/1823862>

Material data - housing

Color (Housing)	green (6021)
Insulating material	PA
Insulating material group	I
CTI according to IEC 60112	600
Flammability rating according to UL 94	V0
Glow wire flammability index GWFI according to EN 60695-2-12	850
Glow wire ignition temperature GWIT according to EN 60695-2-13	775
Temperature for the ball pressure test according to EN 60695-10-2	125 °C

Material data – actuating element

Color ()	()
-----------	-----

Dimensions

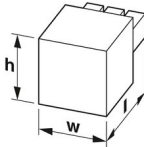
Dimensional drawing	
Pitch	5.08 mm
Width [w]	26.11 mm
Height [h]	10.6 mm
Length [l]	28.1 mm

Notes

Notes on operation	In accordance with IEC 61984, COMBICON connectors have no switching power (COC). During designated use, they must not be plugged in or disconnected when carrying voltage or under load.
--------------------	--

Electrical tests

Air clearances and creepage distances |

Insulating material group	I
Rated insulation voltage (III/3)	250 V
Rated surge voltage (III/3)	4 kV
Rated insulation voltage (III/2)	320 V
Rated surge voltage (III/2)	4 kV
Rated insulation voltage (II/2)	630 V
Rated surge voltage (II/2)	4 kV

Packaging specifications

Type of packaging	packed in cardboard
-------------------	---------------------

ICC 2,5/ 4-STZ-5,08 - PCB connector

1823862

<https://www.phoenixcontact.com/in/products/1823862>

Drawings

Dimensional drawing

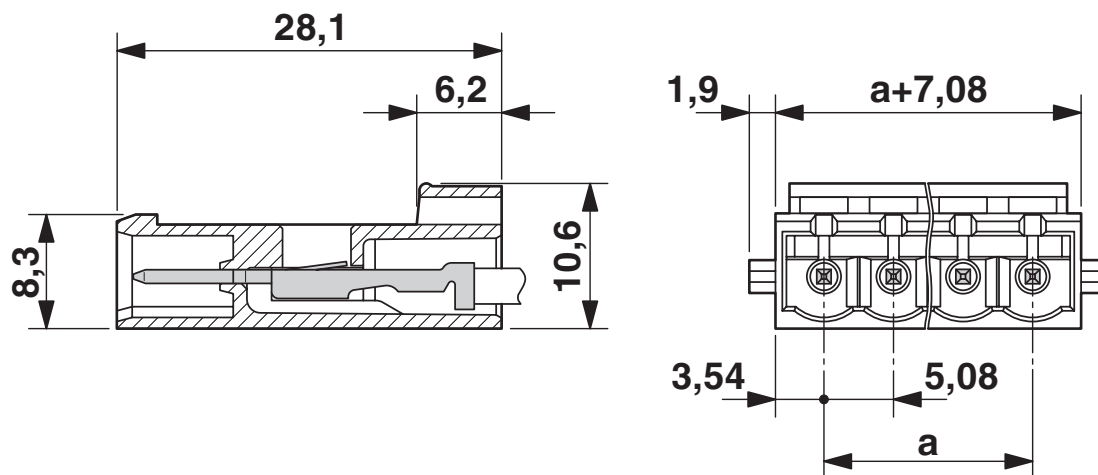

Diagram

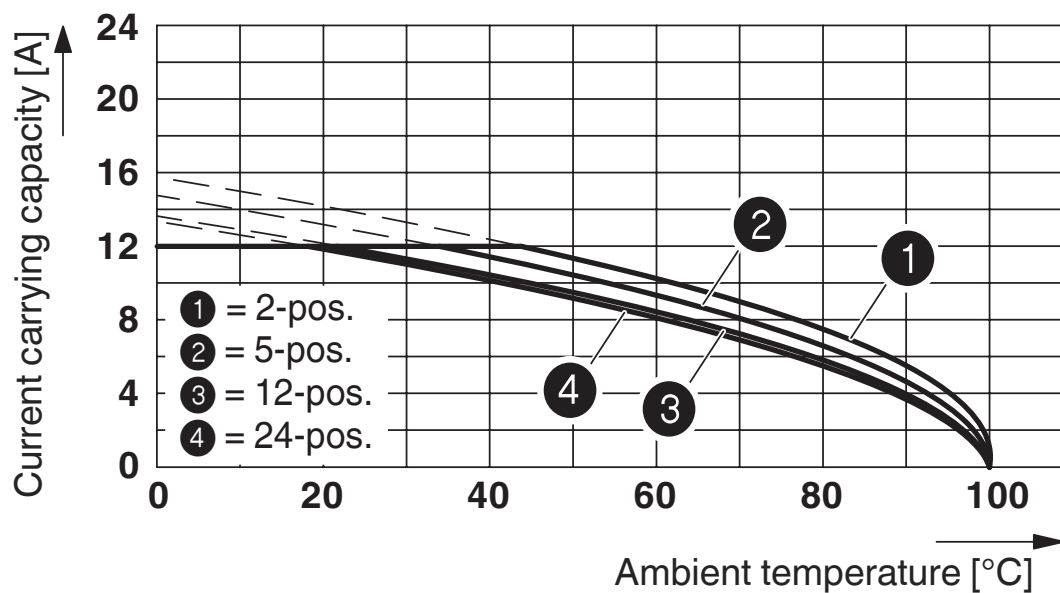

Type: ICC 2,5/...-ST-5,08 with IC 2,5/...-G-5,08; contact: ICC-MT 1,5 - 2,5

ICC 2,5/ 4-STZ-5,08 - PCB connector





1823862

<https://www.phoenixcontact.com/in/products/1823862>

Approvals

 cULus Recognized Approval ID: E60425-19930525				
	Nominal Voltage U_N	Nominal Current I_N	Cross Section AWG	Cross Section mm^2
	300 V	10 A	20 - 14	-
	300 V	10 A	20 - 14	-

 CSA Approval ID: 13631				
	Nominal Voltage U_N	Nominal Current I_N	Cross Section AWG	Cross Section mm^2
	300 V	10 A	20 - 14	-
	300 V	10 A	20 - 14	-

 IECEE CB Scheme Approval ID: DE1-60988-B1B2				
--	--	--	--	--

 EAC Approval ID: B.01687				
--	--	--	--	--

 VDE Zeichengenehmigung Approval ID: 40050648				
--	--	--	--	--

ICC 2,5/ 4-STZ-5,08 - PCB connector



1823862

<https://www.phoenixcontact.com/in/products/1823862>

Classifications

ECLASS

ECLASS-11.0	27460202
ECLASS-12.0	27460202
ECLASS-13.0	27460202

ETIM

ETIM 8.0	EC002638
----------	----------

UNSPSC

UNSPSC 21.0	39121400
-------------	----------

ICC 2,5/ 4-STZ-5,08 - PCB connector



1823862

<https://www.phoenixcontact.com/in/products/1823862>

Environmental Product Compliance

China RoHS	Environmentally friendly use period: unlimited = EFUP-e
	No hazardous substances above threshold values

ICC 2,5/ 4-STZ-5,08 - PCB connector

1823862

<https://www.phoenixcontact.com/in/products/1823862>

Accessories

ICC-MT 0,5-1,0 - Crimp contact

3190577

<https://www.phoenixcontact.com/in/products/3190577>



Module male contact, is inserted into the ICC connector shell after the conductor has been crimped, for conductors from 0.5-1.0 mm²

ICC-MT 0,5-1,0 BA - Crimp contact

3190603

<https://www.phoenixcontact.com/in/products/3190603>



Module male contact, is inserted into the ICC connector shell after the conductor has been crimped, for conductors from 0.5-1.0 mm², ribbon contact

ICC 2,5/ 4-STZ-5,08 - PCB connector

1823862

<https://www.phoenixcontact.com/in/products/1823862>



ICC-MT 1,5-2,5 - Crimp contact

3190580

<https://www.phoenixcontact.com/in/products/3190580>



Module male contact, is inserted into the ICC connector shell after the conductor has been crimped, for conductors from 1.5-2.5 mm²

ICC-MT 1,5-2,5 BA - Crimp contact

3190593

<https://www.phoenixcontact.com/in/products/3190593>



Module male contact, is inserted into the ICC connector shell after the conductor has been crimped, for conductors from 1.5-2.5 mm², ribbon contact

ICC 2,5/ 4-STZ-5,08 - PCB connector

1823862

<https://www.phoenixcontact.com/in/products/1823862>

CRIMPFOX MT 2,5 - Crimping pliers

1204038

<https://www.phoenixcontact.com/in/products/1204038>



Crimping pliers, for crimping conductors to the module female contacts STG-MTN, crimp range: 0.5-2.5 mm², AWG: 20-14

SZS 0,4X2,5 VDE - Screwdriver

1205037

<https://www.phoenixcontact.com/in/products/1205037>



Screwdriver, slot-headed, VDE insulated, size: 0.4 x 2.5 x 80 mm, 2-component grip, with non-slip grip

ICC 2,5/ 4-STZ-5,08 - PCB connector

1823862

<https://www.phoenixcontact.com/in/products/1823862>

STZ 2-MSTBC-5,08 - Strain relief

1810529

<https://www.phoenixcontact.com/in/products/1810529>



Strain relief for snapping into the latching chambers of the plug components, 2-pos., labeling with ZB 6

STZ 4-MSTBC-5,08 - Strain relief

1810532

<https://www.phoenixcontact.com/in/products/1810532>



Strain relief for snapping into the latching chambers of the plug components, 4-pos., labeling with ZB 6

ICC 2,5/ 4-STZ-5,08 - PCB connector

1823862

<https://www.phoenixcontact.com/in/products/1823862>

STZ 8-MSTBC-5,08 - Strain relief

1810516

<https://www.phoenixcontact.com/in/products/1810516>



Strain relief for snapping into the latching chambers of the plug components, 8-pos., labeling with ZB 6

STZ 12-MSTBC-5,08 - Strain relief

1810503

<https://www.phoenixcontact.com/in/products/1810503>



Strain relief for snapping into the latching chambers of the plug components, 12-pos., labeling with ZB 6

ICC 2,5/ 4-STZ-5,08 - PCB connector

1823862

<https://www.phoenixcontact.com/in/products/1823862>



SK 5,08/2,8:FORTL.ZAHLEN - Marker card

0804280

<https://www.phoenixcontact.com/in/products/0804280>

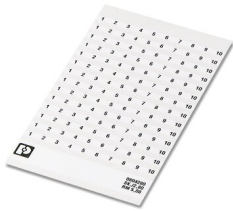

Marker card, white, labeled, horizontal: consecutive numbers 1 ... 10, 11 ... 20, etc. up to 91 ... (99)100, mounting type: adhesive, for terminal block width: 5.08 mm, lettering field size: 5.08 x 2.8 mm

MSTBC 2,5/ 4-STZ-5,08 - PCB connector

1809527

<https://www.phoenixcontact.com/in/products/1809527>



PCB connector, nominal cross section: 2.5 mm², color: green, nominal current: 12 A, rated voltage (III/2): 320 V, type of contact: Socket, number of potentials: 4, number of rows: 1, number of positions: 4, number of connections: 4, product range: MSTBC 2,5/..-STZ, pitch: 5.08 mm, connection method: Crimp connection, conductor/PCB connection direction: 0 °, locking clip: - Locking clip, plug-in system: COMBICON MSTB 2,5, locking: without, mounting: without, type of packaging: packed in cardboard, Corresponding female crimp contacts with current [A] and conductor cross section range [mm²] data: 10A/MSTBC-MT 0,5-1,0 (3190564); 10A/MSTBC-MT 0,5-1,0 BA (3190645); 12A/MSTBC-MT 1,5-2,5 (3190551); 12A/MSTBC-MT 1,5-2,5 BA (3190658). BA = Bandkontakte

ICC 2,5/ 4-STZ-5,08 - PCB connector

1823862

<https://www.phoenixcontact.com/in/products/1823862>



MSTBC 2,5/ 4-STZ-5,08-R - PCB connector

1809064

<https://www.phoenixcontact.com/in/products/1809064>

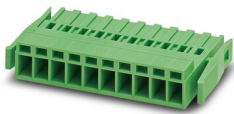

PCB connector, nominal cross section: 2.5 mm², color: green, nominal current: 12 A, rated voltage (III/2): 320 V, type of contact: Socket, number of potentials: 4, number of rows: 1, number of positions: 4, number of connections: 4, product range: MSTBC 2,5/...-STZ-RF, pitch: 5.08 mm, connection method: Crimp connection, conductor/PCB connection direction: 0 °, locking clip: - without locking clip, plug-in system: COMBICON MSTB 2,5, locking: Snap-in locking, mounting: Self-locking flange, type of packaging: packed in cardboard, Corresponding female crimp contacts with current [A] and conductor cross section range [mm²] data: 10A/MSTBC-MT 0,5-1,0 (3190564); 10A/MSTBC-MT 0,5-1,0 BA (3190645); 12A/MSTBC-MT 1,5-2,5 (3190551); 12A/MSTBC-MT 1,5-2,5 BA (3190658). BA = Bandkontakte

MVSTBR 2,5/ 4-ST-5,08 - PCB connector

1792265

<https://www.phoenixcontact.com/in/products/1792265>



PCB connector, nominal cross section: 2.5 mm², color: green, nominal current: 12 A, rated voltage (III/2): 320 V, contact surface: Tin, type of contact: Socket, number of potentials: 4, number of rows: 1, number of positions: 4, number of connections: 4, product range: MVSTBR 2,5/...-ST, pitch: 5.08 mm, connection method: Screw connection with tension sleeve, screw head form: L Slotted, conductor/PCB connection direction: 90 °, locking clip: - Locking clip, plug-in system: COMBICON MSTB 2,5, locking: without, mounting: without, type of packaging: packed in cardboard

ICC 2,5/ 4-STZ-5,08 - PCB connector

1823862

<https://www.phoenixcontact.com/in/products/1823862>

IC 2,5/ 4-G-5,08 - PCB header

1786420

<https://www.phoenixcontact.com/in/products/1786420>



PCB headers, nominal cross section: 2.5 mm², color: green, nominal current: 12 A, rated voltage (III/2): 320 V, contact surface: Tin, type of contact: Socket, number of potentials: 4, number of rows: 1, number of positions: 4, number of connections: 4, product range: IC 2,5/...-G, pitch: 5.08 mm, mounting: Wave soldering, pin layout: Linear pinning, solder pin [P]: 3.5 mm, number of solder pins per potential: 2, plug-in system: COMBICON MSTB 2,5, Pin connector pattern alignment: Standard, locking: without, mounting: without, type of packaging: packed in cardboard

ICV 2,5/ 4-G-5,08 - PCB header

1785968

<https://www.phoenixcontact.com/in/products/1785968>

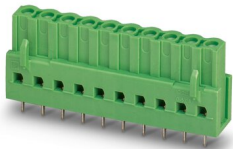

PCB headers, nominal cross section: 2.5 mm², color: green, nominal current: 12 A, rated voltage (III/2): 320 V, contact surface: Tin, type of contact: Socket, number of potentials: 4, number of rows: 1, number of positions: 4, number of connections: 4, product range: ICV 2,5/...-G, pitch: 5.08 mm, mounting: Wave soldering, pin layout: Linear pinning, solder pin [P]: 3.6 mm, number of solder pins per potential: 2, plug-in system: COMBICON MSTB 2,5, Pin connector pattern alignment: Standard, locking: without, mounting: without, type of packaging: packed in cardboard

ICC 2,5/ 4-STZ-5,08 - PCB connector

1823862

<https://www.phoenixcontact.com/in/products/1823862>



MSTBT 2,5/ 4-ST-5,08 - PCB connector

1780002

<https://www.phoenixcontact.com/in/products/1780002>



PCB connector, nominal cross section: 2.5 mm², color: green, nominal current: 12 A, rated voltage (III/2): 320 V, contact surface: Tin, type of contact: Socket, number of potentials: 4, number of rows: 1, number of positions: 4, number of connections: 4, product range: MSTBT 2,5/...-ST, pitch: 5.08 mm, connection method: Screw connection with tension sleeve, screw head form: L Slotted, conductor/PCB connection direction: 0 °, locking clip: - Locking clip, plug-in system: COMBICON MSTB 2,5, locking: without, mounting: without, type of packaging: packed in cardboard

FRONT-MSTB 2,5/ 4-ST-5,08 - PCB connector

1777303

<https://www.phoenixcontact.com/in/products/1777303>

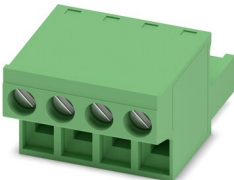

PCB connector, nominal cross section: 2.5 mm², color: green, nominal current: 12 A, rated voltage (III/2): 320 V, contact surface: Tin, type of contact: Socket, number of potentials: 4, number of rows: 1, number of positions: 4, number of connections: 4, product range: FRONT-MSTB 2,5/...-ST, pitch: 5.08 mm, connection method: Front screw connection, screw head form: L Slotted, conductor/PCB connection direction: 0 °, locking clip: - Locking clip, plug-in system: COMBICON MSTB 2,5, locking: without, mounting: without, type of packaging: packed in cardboard

ICC 2,5/ 4-STZ-5,08 - PCB connector

1823862

<https://www.phoenixcontact.com/in/products/1823862>



MSTB 2,5/ 4-STZ-5,08 - PCB connector

1776155

<https://www.phoenixcontact.com/in/products/1776155>



PCB connector, nominal cross section: 2.5 mm², color: green, nominal current: 12 A, rated voltage (III/2): 320 V, contact surface: Tin, type of contact: Socket, number of potentials: 4, number of rows: 1, number of positions: 4, number of connections: 4, product range: MSTB 2,5/..-STZ, pitch: 5.08 mm, connection method: Screw connection with tension sleeve, screw head form: L Slotted, conductor/PCB connection direction: 0 °, locking clip: - Locking clip, plug-in system: COMBICON MSTB 2,5, locking: without, mounting: without, type of packaging: packed in cardboard

MSTBP 2,5/ 4-ST-5,08 - PCB connector

1769036

<https://www.phoenixcontact.com/in/products/1769036>



PCB connector, nominal cross section: 2.5 mm², color: green, nominal current: 12 A, rated voltage (III/2): 320 V, contact surface: Tin, type of contact: Socket, number of potentials: 4, number of rows: 1, number of positions: 4, number of connections: 4, product range: MSTBP 2,5/..-ST, pitch: 5.08 mm, connection method: Screw connection with tension sleeve, screw head form: L Slotted, conductor/PCB connection direction: 0 °, locking clip: - Locking clip, plug-in system: COMBICON MSTB 2,5, locking: without, mounting: without, type of packaging: packed in cardboard

ICC 2,5/ 4-STZ-5,08 - PCB connector

1823862

<https://www.phoenixcontact.com/in/products/1823862>



MSTB 2,5/ 4-ST-5,08 - PCB connector

1757035

<https://www.phoenixcontact.com/in/products/1757035>

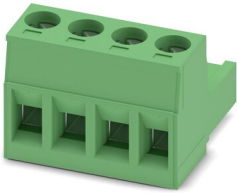

PCB connector, nominal cross section: 2.5 mm², color: green, nominal current: 12 A, rated voltage (III/2): 320 V, contact surface: Tin, type of contact: Socket, number of potentials: 4, number of rows: 1, number of positions: 4, number of connections: 4, product range: MSTB 2,5/..-ST, pitch: 5.08 mm, connection method: Screw connection with tension sleeve, screw head form: L Slotted, conductor/PCB connection direction: 0 °, locking clip: - Locking clip, plug-in system: COMBICON MSTB 2,5, locking: without, mounting: without, type of packaging: packed in cardboard

QC 1/ 4-ST-5,08 - PCB connector

1883271

<https://www.phoenixcontact.com/in/products/1883271>

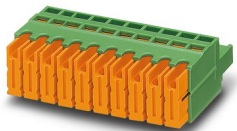

PCB connector, nominal cross section: 1 mm², color: green, nominal current: 10 A, rated voltage (III/2): 630 V, contact surface: Tin, type of contact: Socket, number of potentials: 4, number of rows: 1, number of positions: 4, number of connections: 4, product range: QC 1/..-ST, pitch: 5.08 mm, connection method: Displacement connection, conductor/PCB connection direction: 0 °, locking clip: - Locking clip, plug-in system: COMBICON MSTB 2,5, locking: without, mounting: without, type of packaging: packed in cardboard

Phoenix Contact 2023 © - all rights reserved
<https://www.phoenixcontact.com>

PHOENIX CONTACT (I) Pvt. Ltd.
A-58/2, Okhla Industrial Area, Phase - II, New Delhi-110 020

+91.1275.71420
info@phoenixcontact.co.in