

BC 71,6 OT U11 KMGY - Upper part of housing



2896050

<https://www.phoenixcontact.com/in/products/2896050>

Please be informed that the data shown in this PDF document is generated from our Online Catalog. Please find the complete data in the user documentation. Our General Terms of Use for Downloads are valid.

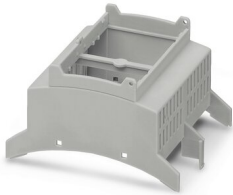

DIN rail housing for use in distribution boards in accordance with DIN 43880, Upper housing part (U11) with vents, Installation depth connection technology: 11.1 mm, width: 71.6 mm, height: 89.7 mm, depth: 54.85 mm, color: light grey (7035)

Your advantages

- Coordinated housing and connection system for faster device development
- Individual online configuration for diverse applications in building automation
- Variety of connection technology
- Can be mounted on the DIN rail or the wall
- With DIN-rail-mountable bus connector and power connector system as an option
- Tool-free mounting
- Available in overall widths from one to nine HP (17.8 mm ... 161.6 mm)
- Compliant with DIN EN 43880

Commercial Data

Item number	2896050
Packing unit	10 pc
Minimum order quantity	10 pc
Sales Key	ACH
Product Key	ACHBAB
Catalog Page	Page 699 (C-1-2013)
GTIN	4046356096478
Weight per Piece (including packing)	29.9 g
Weight per Piece (excluding packing)	28 g
Customs tariff number	85389099
Country of origin	DE

BC 71,6 OT U11 KMGY - Upper part of housing



2896050

<https://www.phoenixcontact.com/in/products/2896050>

Technical Data

Notes

Assembly instruction:	Refer to the data sheet for the range in the download area.
-----------------------	---

Product properties

Product type	Upper housing part
Product family	BC OT U11
Max. number of positions	44 (pitch: 2.5 mm)
	32 (pitch: 3.5 mm)
	24 (pitch: 5 mm)
	16 (pitch: 7.5 mm)
)
Type	Upper housing part (U11) with vents
Housing type	DIN rail housing for use in distribution boards in accordance with DIN 43880
Ventilation openings present	yes
Housing series	BC

Dimensions

PCB design

PCB thickness	1.4 mm ... 1.8 mm
---------------	-------------------

Material specifications

Color	light grey (7035)
Flammability rating according to UL 94	V0
Surface characteristics	untreated
Housing material	Polycarbonate

Environmental and real-life conditions

Vibration test

Specification	IEC 60068-2-6:2007-12
Frequency	10 - 150 - 10 Hz
Sweep speed	1 octave/min
Amplitude	0.15 mm (10 Hz ... 58.1 Hz)
Acceleration	2g (58.1 Hz ... 150 Hz)
Test duration per axis	2.5 h
Test directions	X-, Y- and Z-axis

Glow-wire test

Specification	IEC 60695-2-11:2014-02
Temperature	850 °C
Time of exposure	30 s

BC 71,6 OT U11 KMGY - Upper part of housing



2896050

<https://www.phoenixcontact.com/in/products/2896050>

Mechanical strength / tumbling barrel

Specification	IEC 60068-2-31:2008-05
Height of fall	50 cm
Frequency	50

Shocks

Specification	IEC 60068-2-27:2008-02
Pulse shape	Half-sine
Acceleration	15g
Shock duration	11 ms
Number of shocks per direction	3
Test directions	X-, Y- and Z-axis (pos. and neg.)

Degree of protection (IP code)

Specification	IEC 60529:1989-11 + AMD 1:1999-11 + AMD 2:2013-08
---------------	---

Ambient conditions

Max. IP code to attain	IP20
Ambient temperature (operation)	-40 °C ... 105 °C (depending on power dissipation)
Ambient temperature (storage/transport)	-40 °C ... 70 °C
Ambient temperature (assembly)	-5 °C ... 100 °C
Relative humidity (storage/transport)	95 %

PCB data

Number of PCB holders	8
Type of PCB mount	Latching
Thickness of the PCB	1.4 mm ... 1.8 mm

Mounting

Mounting type	Snap in
Mounting position	Vertical (horizontal DIN rail)

Packaging specifications

Type of packaging	packed in cardboard
Outer packaging type	Carton

BC 71,6 OT U11 KMGY - Upper part of housing

2896050

<https://www.phoenixcontact.com/in/products/2896050>



Drawings

Dimensional drawing

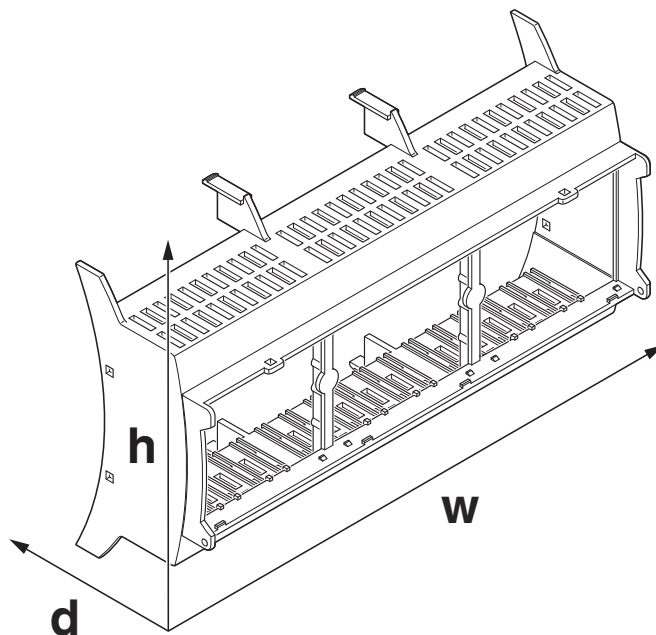

Schematic figure for illustrating the item dimensions. The figure is not of the desired product. For further details, refer to the product drawings in the "Downloads" tab.

BC 71,6 OT U11 KMGY - Upper part of housing



2896050

<https://www.phoenixcontact.com/in/products/2896050>

Approvals



EAC

Approval ID: B.01687



UL Recognized

Approval ID: FILE E 240868

BC 71,6 OT U11 KMGY - Upper part of housing



2896050

<https://www.phoenixcontact.com/in/products/2896050>

Classifications

ECLASS

ECLASS-10.0.1	27182702
ECLASS-11.0	27182702

ETIM

ETIM 8.0	EC001031
----------	----------

UNSPSC

UNSPSC 21.0	31261500
-------------	----------

BC 71,6 OT U11 KMGY - Upper part of housing



2896050

<https://www.phoenixcontact.com/in/products/2896050>

Environmental Product Compliance

China RoHS	Environmentally friendly use period: unlimited = EFUP-e
	No hazardous substances above threshold values

2896050

<https://www.phoenixcontact.com/in/products/2896050>

Mandatory Accessories

MKDSN 1,5/ 2 HT BK - PCB terminal block

1985849

<https://www.phoenixcontact.com/in/products/1985849>



PCB terminal block, nominal current: 13.5 A, rated voltage (III/2): 320 V, nominal cross section: 1.5 mm², number of potentials: 2, number of rows: 1, number of positions per row: 2, product range: MKDSN 1,5/..-HT, pitch: 5 mm, connection method: Screw connection with tension sleeve, screw head form: L Slotted, mounting: THR soldering, conductor/PCB connection direction: 0 °, color: black, Pin layout: Linear pinning, Solder pin [P]: 3.5 mm, number of solder pins per potential: 1, type of packaging: packed in cardboard. This article can be soldered in the reflow furnace together with SMD components.

MKDSN 2,5/ 3 HT BK - PCB terminal block

1985933

<https://www.phoenixcontact.com/in/products/1985933>



PCB terminal block, nominal current: 16 A, rated voltage (III/2): 320 V, nominal cross section: 2.5 mm², number of potentials: 3, number of rows: 1, number of positions per row: 3, product range: MKDSN 2,5/..-HT, pitch: 5 mm, connection method: Screw connection with tension sleeve, screw head form: L Slotted, mounting: THR soldering, conductor/PCB connection direction: 0 °, color: black, Pin layout: Linear pinning, Solder pin [P]: 3.5 mm, number of solder pins per potential: 1, type of packaging: packed in cardboard. This article can be soldered in the reflow furnace together with SMD components.

BC 71,6 OT U11 KMGY - Upper part of housing

2896050

<https://www.phoenixcontact.com/in/products/2896050>

MKDS 1,5/ 3 - PCB terminal block

1715035

<https://www.phoenixcontact.com/in/products/1715035>

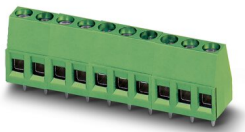

PCB terminal block, nominal current: 17.5 A, rated voltage (III/2): 400 V, nominal cross section: 1.5 mm², number of potentials: 3, number of rows: 1, number of positions per row: 3, product range: MKDS 1,5, pitch: 5 mm, connection method: Screw connection with tension sleeve, screw head form: L Slotted, mounting: Wave soldering, conductor/PCB connection direction: 0 °, color: green, Pin layout: Linear pinning, Solder pin [P]: 3.5 mm, number of solder pins per potential: 1, type of packaging: packed in cardboard. The article can be aligned to create different nos. of positions!

MKDSN 2,5/ 3 - PCB terminal block

1890976

<https://www.phoenixcontact.com/in/products/1890976>



PCB terminal block, nominal current: 24 A, rated voltage (III/2): 400 V, nominal cross section: 2.5 mm², number of potentials: 3, number of rows: 1, number of positions per row: 3, product range: MKDSN 2,5, pitch: 5 mm, connection method: Screw connection with tension sleeve, screw head form: H1L Philipps recess with slotted Torx, mounting: Wave soldering, conductor/PCB connection direction: 0 °, color: green, Pin layout: Linear pinning, Solder pin [P]: 3.5 mm, number of solder pins per potential: 1, type of packaging: packed in cardboard. The article can be aligned to create different nos. of positions!

BC 71,6 OT U11 KMGY - Upper part of housing

2896050

<https://www.phoenixcontact.com/in/products/2896050>

MKKDSH 3/ 3 - PCB terminal block

1721346

<https://www.phoenixcontact.com/in/products/1721346>



PCB terminal block, nominal current: 24 A, rated voltage (III/2): 400 V, nominal cross section: 2.5 mm², number of potentials: 3, number of rows: 1, number of positions per row: 3, product range: MKKDSH 3, pitch: 5 mm, connection method: Screw connection with tension sleeve, screw head form: L Slotted, mounting: Wave soldering, conductor/PCB connection direction: 0 °, color: green, Pin layout: Linear pinning, Solder pin [P]: 5 mm, number of solder pins per potential: 1, type of packaging: packed in cardboard. The article can be aligned to create different nos. of positions!

GMKDS 1,5/ 2 - PCB terminal block

1717020

<https://www.phoenixcontact.com/in/products/1717020>



PCB terminal block, nominal current: 17.5 A, rated voltage (III/2): 630 V, nominal cross section: 1.5 mm², number of potentials: 2, number of rows: 1, number of positions per row: 2, product range: GMKDS 1,5, pitch: 7.5 mm, connection method: Screw connection with tension sleeve, screw head form: L Slotted, mounting: Wave soldering, conductor/PCB connection direction: 0 °, color: green, Pin layout: Linear pinning, Solder pin [P]: 3.5 mm, number of solder pins per potential: 1, type of packaging: packed in cardboard. The article can be aligned to create different nos. of positions!

BC 71,6 OT U11 KMGY - Upper part of housing

2896050

<https://www.phoenixcontact.com/in/products/2896050>

GMKDSP 3/ 2 - PCB terminal block

1732021

<https://www.phoenixcontact.com/in/products/1732021>



PCB terminal block, nominal current: 24 A, rated voltage (III/2): 630 V, nominal cross section: 2.5 mm², number of potentials: 2, number of rows: 1, number of positions per row: 2, product range: GMKDSP 3, pitch: 7.5 mm, connection method: Screw connection with tension sleeve, screw head form: L Slotted, mounting: Wave soldering, conductor/PCB connection direction: 0 °, color: green, Pin layout: Linear pinning, Solder pin [P]: 5 mm, number of solder pins per potential: 1, type of packaging: packed in cardboard. The article can be aligned to create different nos. of positions!

SPTA 1/ 8-3,5 - PCB terminal block

1752162

<https://www.phoenixcontact.com/in/products/1752162>



PCB terminal block, nominal current: 9 A, rated voltage (III/2): 200 V, nominal cross section: 1 mm², number of potentials: 8, number of rows: 1, number of positions per row: 8, product range: SPTA 1/, pitch: 3.5 mm, connection method: Push-in spring connection, mounting: Wave soldering, conductor/PCB connection direction: 65 °, color: green, Pin layout: Linear pinning, Solder pin [P]: 3.5 mm, number of solder pins per potential: 1, type of packaging: packed in cardboard

BC 71,6 OT U11 KMGY - Upper part of housing

2896050

<https://www.phoenixcontact.com/in/products/2896050>

SPTA 1/ 6-5,0 - PCB terminal block

1752256

<https://www.phoenixcontact.com/in/products/1752256>



PCB terminal block, nominal current: 9 A, rated voltage (III/2): 320 V, nominal cross section: 1 mm², number of potentials: 6, number of rows: 1, number of positions per row: 6, product range: SPTA 1/, pitch: 5 mm, connection method: Push-in spring connection, mounting: Wave soldering, conductor/PCB connection direction: 65 °, color: green, Pin layout: Linear pinning, Solder pin [P]: 3.5 mm, number of solder pins per potential: 1, type of packaging: packed in cardboard

FK-MPT 0,5/ 8-3,5-H - PCB terminal block

1928822

<https://www.phoenixcontact.com/in/products/1928822>

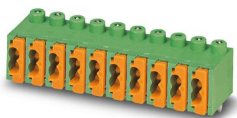

PCB terminal block, nominal current: 4 A, rated voltage (III/2): 250 V, nominal cross section: 0.5 mm², number of potentials: 8, number of rows: 1, number of positions per row: 8, product range: FK-MPT 0,5/...-H, pitch: 3.5 mm, connection method: Push-in spring connection, mounting: Wave soldering, conductor/PCB connection direction: 0 °, color: green, Pin layout: Linear pinning, Solder pin [P]: 4 mm, number of solder pins per potential: 1, type of packaging: packed in cardboard

BC 71,6 OT U11 KMGY - Upper part of housing

2896050

<https://www.phoenixcontact.com/in/products/2896050>

FK-MPT 0,5/ 8-ST-3,5 - PCB connector

1913989

<https://www.phoenixcontact.com/in/products/1913989>



PCB connector, nominal cross section: 0.5 mm², color: green, nominal current: 4 A, rated voltage (III/2): 250 V, contact surface: Tin, type of contact: Female connector, number of potentials: 8, number of rows: 1, number of positions: 8, number of connections: 16, product range: FK-MPT 0,5/...-ST, pitch: 3.5 mm, connection method: Push-in spring connection, conductor/PCB connection direction: 0 °, plug-in system: COMBICON PST 1,0, locking: without, mounting: without, type of packaging: packed in cardboard

PTSA 0,5/11-2,5-Z - PCB terminal block

1990096

<https://www.phoenixcontact.com/in/products/1990096>

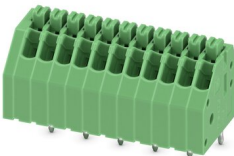

PCB terminal block, nominal current: 2 A, rated voltage (III/2): 250 V, nominal cross section: 0.5 mm², number of potentials: 11, number of rows: 1, number of positions per row: 11, product range: PTSA 0,5, pitch: 2.5 mm, connection method: Push-in spring connection, mounting: Wave soldering, conductor/PCB connection direction: 45 °, color: green, Pin layout: Zigzag pinning M, Solder pin [P]: 3.6 mm, number of solder pins per potential: 1, type of packaging: packed in cardboard. Offset soldering legs, two-rowed

BC 71,6 OT U11 KMGY - Upper part of housing

2896050

<https://www.phoenixcontact.com/in/products/2896050>

PTSA 0,5/11-2,5-F - PCB terminal block

1989832

<https://www.phoenixcontact.com/in/products/1989832>

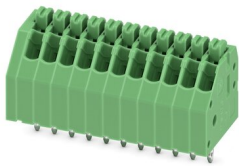

PCB terminal block, nominal current: 2 A, rated voltage (III/2): 250 V, nominal cross section: 0.5 mm², number of potentials: 11, number of rows: 1, number of positions per row: 11, product range: PTSA 0,5, pitch: 2.5 mm, connection method: Push-in spring connection, mounting: Wave soldering, conductor/PCB connection direction: 45 °, color: green, Pin layout: Linear pinning, Solder pin [P]: 3.6 mm, number of solder pins per potential: 1, type of packaging: packed in cardboard. Soldering legs in front area, one-rowed

PTS 1,5/ 6-5,0-H - PCB terminal block

1792902

<https://www.phoenixcontact.com/in/products/1792902>

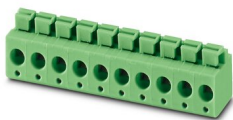

PCB terminal block, nominal current: 16 A, rated voltage (III/2): 400 V, nominal cross section: 1.5 mm², number of potentials: 6, number of rows: 1, number of positions per row: 6, product range: PTS 1,5/..-H, pitch: 5 mm, connection method: Push-in spring connection, mounting: Wave soldering, conductor/PCB connection direction: 0 °, color: green, Pin layout: Linear pinning, Solder pin [P]: 2.5 mm, number of solder pins per potential: 1, type of packaging: packed in cardboard

BC 71,6 OT U11 KMGY - Upper part of housing

2896050

<https://www.phoenixcontact.com/in/products/2896050>

PT 1,5/ 6-5,0-H - PCB terminal block

1935200

<https://www.phoenixcontact.com/in/products/1935200>



PCB terminal block, nominal current: 17.5 A, rated voltage (III/2): 400 V, nominal cross section: 1.5 mm², number of potentials: 6, number of rows: 1, number of positions per row: 6, product range: PT 1,5/..-H, pitch: 5 mm, connection method: Screw connection with wire protector, mounting: Wave soldering, conductor/PCB connection direction: 0 °, color: green, Pin layout: Linear pinning, Solder pin [P]: 3.5 mm, number of solder pins per potential: 1, type of packaging: packed in cardboard

PT 1,5/ 6-PH-5,0 - PCB connector

1755622

<https://www.phoenixcontact.com/in/products/1755622>



PCB connector, nominal cross section: 1.5 mm², color: green, nominal current: 10 A, rated voltage (III/2): 400 V, contact surface: Tin, type of contact: Female connector, number of potentials: 6, number of rows: 1, number of positions: 6, number of connections: 6, product range: PT 1,5/..-PH, pitch: 5 mm, connection method: Screw connection with tension sleeve, screw head form: H1L Philipps recess with slotted Torx, conductor/PCB connection direction: 0 °, plug-in system: COMBICON PST 1,3, locking: without, mounting: without, type of packaging: packed in cardboard

BC 71,6 OT U11 KMGY - Upper part of housing

2896050

<https://www.phoenixcontact.com/in/products/2896050>

PST 1,3/ 6-5,0 - Pin strip

1933228

<https://www.phoenixcontact.com/in/products/1933228>



Pin strip, nominal cross section: 1.5 mm², color: black, nominal current: 12 A (depends on the plug used), rated voltage (III/2): 320 V, contact surface: Tin, type of contact: Male connector, number of potentials: 6, number of rows: 1, number of positions: 6, number of connections: 6, product range: PST 1,3/..-V, pitch: 5 mm, mounting: THR soldering, pin layout: Linear pinning, solder pin [P]: 3.5 mm, plug-in system: COMBICON PST 1,3, locking: without, mounting: without, type of packaging: packed in cardboard, The maximum current depends on the plug used. The lower of the two current values apply for plug and pin strip. The pin strip is made of highly temperature resistant plastic and is thus suitable for the reflow process.

BC 71,6 DKL R KMGY - Housing cover

2896160

<https://www.phoenixcontact.com/in/products/2896160>



DIN rail housing for use in distribution boards in accordance with DIN 43880, Latching cover (non-detachable), width: 71.6 mm, height: 45 mm, depth: 8 mm, color: light grey (7035)

BC 71,6 OT U11 KMGY - Upper part of housing

2896050

<https://www.phoenixcontact.com/in/products/2896050>

BC 71,6 DKL S TRANS - Housing cover

2896128

<https://www.phoenixcontact.com/in/products/2896128>



DIN rail housing for use in distribution boards in accordance with DIN 43880, transparent hinged cover, can be sealed, Including insertion plate, width: 71.6 mm, height: 45 mm, depth: 8 mm, color: transparent/light gray (7035)

SPT-THR 1,5/ 8-V-3,5 P20 R72 - PCB terminal block

1823256

<https://www.phoenixcontact.com/in/products/1823256>



PCB terminal block, nominal current: 13.5 A, rated voltage (III/2): 160 V, nominal cross section: 1.5 mm², number of potentials: 8, number of rows: 1, number of positions per row: 8, product range: SPT 1,5/-V-THR, pitch: 3.5 mm, connection method: Push-in spring connection, mounting: THR soldering, conductor/PCB connection direction: 90 °, color: black, Pin layout: Linear pinning, Solder pin [P]: 2 mm, number of solder pins per potential: 2, type of packaging: 72 mm wide tape

BC 71,6 OT U11 KMGY - Upper part of housing

2896050

<https://www.phoenixcontact.com/in/products/2896050>

SPT-THR 1,5/ 6-V-5,0 P20 R56 - PCB terminal block

1823450

<https://www.phoenixcontact.com/in/products/1823450>



PCB terminal block, nominal current: 13.5 A, rated voltage (III/2): 320 V, nominal cross section: 1.5 mm², number of potentials: 6, number of rows: 1, number of positions per row: 6, product range: SPT 1,5/..-V-THR, pitch: 5 mm, connection method: Push-in spring connection, mounting: THR soldering, conductor/PCB connection direction: 90 °, color: black, Pin layout: Linear pinning, Solder pin [P]: 2 mm, number of solder pins per potential: 2, type of packaging: 56 mm wide tape

Accessories

HS LC-V-D3/ R2XC1-5,08 - Fiber optic

2202311

<https://www.phoenixcontact.com/in/products/2202311>



Multiple light guides, passive, rigid, can be used for the BC housing range (housing must be processed)

BC 71,6 OT U11 KMGY - Upper part of housing

2896050

<https://www.phoenixcontact.com/in/products/2896050>



HS LC-V-D3/ R3XC1-5,08 - Fiber optic

2202312

<https://www.phoenixcontact.com/in/products/2202312>



Multiple light guides, passive, rigid, can be used for the BC housing range (housing must be processed)

BC 35,6 BS U11 KMGY - Filler plugs

2896209

<https://www.phoenixcontact.com/in/products/2896209>



DIN rail housing for use in distribution boards in accordance with DIN 43880, Filler plug for unoccupied terminal points (U11), width: 35.6 mm, height: 27.27 mm, depth: 11.05 mm, color: light grey (7035)

Phoenix Contact 2023 © - all rights reserved

<https://www.phoenixcontact.com>

PHOENIX CONTACT (I) Pvt. Ltd.

A-58/2, Okhla Industrial Area, Phase - II, New Delhi-110 020

+91.1275.71420

info@phoenixcontact.co.in