

- **Non-resettable Fuses**

- Sub-miniature fuse-links
- Miniature fuse-links

**Nicht rückstellende Sicherungen**

- Kleinst-Sicherungseinsätze
- G-Sicherungseinsätze



**Miniature fuse-links**

**Explanations, application notes**

The design engineer of electrical equipment is responsible for its safety and functioning to humans, animals and real values. Above all, it is his task to make sure that the state of the art as well as the valid national and international standards and regulations be observed.

The following information about fuse-links and their application are to be taken into consideration when selecting a fuse-link.

In view of the product liability of electrical equipment the selection of the most suitable fuse-link is of great importance.

**1. Fuse**

A fuse is a self-acting device that, by the fusing of one of its specially designed and proportioned components, opens the circuit in which it is inserted by breaking the current when this exceeds a given value for a sufficient time.

Definition according to IEC 60127:

The fuse comprises all the parts that form the complete device, that means fuseholder and fuse-link.

Definition according to UL 248-1:

A North American fuse is an IEC fuse-link. An IEC fuse is a North American fuse with a fuse-holder.

**2. Fuse-link (IEC 60127)**

The part of a fuse including the fuse-element intended to be replaced after the fuse has operated. Fuse-links according to IEC 60127 relate to miniature fuses for the protection of electric appliances, electronic equipment and components thereof normally intended to be used indoors. These fuse-links are not permitted for equipment, which has to operate under special circumstances, e.g. in a corrosive or explosive environment.

**3. Miniature fuse-link (IEC 60127)**

An enclosed fuse-link of rated breaking capacity not exceeding 2 kA and which has at least one of its principal dimensions exceeding 10 mm.

**4. Sub-miniature fuse-link (IEC 60127)**

A miniature fuse-link of which the case (body) has no principal dimensions exceeding 10 mm.

Sub-miniature fuse-links are especially suitable for printed circuit boards. They are available for the through hole technique and surface mounting technique (SMT).

**5. Standards for fuse-links**

IEC*	EN	NF	UL	CSA	Title
IEC 60127					Miniature fuses (general title)
IEC 60127-1	EN 60127-1				Part 1: Definitions for miniature fuses and general requirements for miniature fuse-links
IEC 60127-2	EN 60127-2				Part 2: Cartridge fuse-links
IEC 60127-3	EN 60127-3				Part 3: Sub-miniature fuse-links
IEC 60127-4	EN 60127-4				Part 4: Universal modular fuse-links
IEC 60127-5	EN 60127-5				Part 5: Guidelines for quality assessment for miniature fuse-links
		NF C 93-435			Cartridge Fuses with improved characteristics
			UL 248-1 UL 248-14 (formerly UL 198 G)		Low-Voltage Fuses: General requirements Low-Voltage Fuses: Supplemental Fuses
				CSA/C22.2 No. 248.1 CSA/C22.2 No. 248.14 (formerly CSA/C22.2 No. 59)	see UL 248

IEC: International Electrotechnical Commission  
EN: European Standard

NF: French Standard  
UL: Underwriters Laboratories Inc. USA

CSA: Canadian Standards Association

**Geräteschutz-Sicherungseinsätze**

**Erläuterungen, Anwendungshinweise**

Der Entwicklungsingenieur eines elektrischen Betriebsmittels ist verantwortlich für dessen Sicherheit und Funktion gegenüber Menschen, Tieren und Sachwerten. Insbesondere ist es seine Aufgabe dafür zu sorgen, dass die anerkannten Regeln der Technik sowie die entsprechenden gültigen nationalen und internationalen Normen und Vorschriften eingehalten werden.

Die folgenden Informationen über Sicherungseinsätze und deren Anwendung sind bei der Auswahl eines Sicherungseinsatzes gebührend zu berücksichtigen.

Im Hinblick auf die Produktesicherheit eines elektrischen Betriebsmittels kommt der Auswahl des richtigen Sicherungseinsatzes eine grosse Bedeutung zu.

**1. Sicherung**

Eine Sicherung ist eine selbsttätig wirkende Vorrichtung, die durch Schmelzen eines besonders zu diesem Zweck vorgesehenen und bemessenen Teiles den Stromkreis unterbricht, wenn der Strom einen bestimmten Wert während einer bestimmten Dauer überschreitet.

Definition nach IEC 60127:

Die Sicherung umfasst alle Teile, die zur vollständigen Schaltvorrichtung gehören, d.h. Sicherungshalter und Sicherungseinsatz.

Definition nach UL 248-1:

Eine nordamerikanische Sicherung entspricht einem IEC-Sicherungseinsatz. Eine IEC-Sicherung ist ein nordamerikanischer Sicherungseinsatz mit einem Sicherungshalter.

**2. Sicherungseinsatz (IEC 60127)**

Der Teil der Sicherung, der nach dem Ansprechen der Sicherung durch einen neuen ersetzt werden muss und der den Schmelzleiter enthält. Sicherungseinsätze nach IEC 60127, EN 60127, UL 248-14 sind zum Schutz von elektrischen Geräten, elektronischen Ausrüstungen und Teilen derselben bestimmt, üblicherweise für den Gebrauch in Innenräumen. Diese Sicherungseinsätze sind nicht zugelassen für Geräte, die unter besonderen Bedingungen, wie z.B. in korrosiver oder explosiver Atmosphäre verwendet werden.

**3. Geräte (G-)Sicherungseinsatz (IEC 60127)**

Ein geschlossener Sicherungseinsatz mit einem Ausschaltvermögen nicht grösser als 2 kA, bei dem mindestens ein Hauptmass 10 mm nicht überschreitet.

**4. Kleinst-Sicherungseinsatz (IEC 60127)**

Ein Geräte-Sicherungseinsatz, bei dem die Hauptmasse des Gehäuses 10 mm nicht überschreiten.

Kleinst-Sicherungseinsätze sind insbesondere für Leiterplatten geeignet. Sie sind lieferbar für die Durchstecktechnik und für die Oberflächen-Montagetechnik (SMT).

**5. Normen für Sicherungseinsätze**

## \* Change of IEC publication numbers

In 1997 the IEC introduced a new numbering system for all new and existing standards and publications. For example, IEC 127-1 is now referred to as IEC 60127-1.

## 6. Rated voltage $U_n$

The rated voltage is the voltage up to which the fuse-link correctly interrupts an overcurrent.

The rated voltage of a fuse-link must be greater than or equal to the operating voltage of the equipment which is to be protected.

The use during operating voltages below the rated voltage of the fuse-link is permitted only, when the instructions regarding voltage drop (pos. 8) are taken into consideration.

The fuse-links are on principle suitable for use at alternating and direct voltage. The breaking capacity at direct-voltage is however considerably lower than the one at alternating voltage. The performance of the fuse-link at direct-voltage mainly depends on the size of the time-constant  $\tau = \frac{1}{R}$  of the load circuit.

## 7. Rated current $I_n$

The rated current of the fuse-link corresponds to the operating current of the equipment to be protected. Basically there are two different rated current definitions:

- On fuse-links according to IEC 60127 and EN 60127 the rated current corresponds to the current, which the fuse-link can be exposed to continually, according to the standardized regulations, without interrupting the fuse-link.
- On fuse-links according to UL 248-14 however, the rated current corresponds to the current, which would interrupt the fuse-link already after a few hours. The current, which according to IEC, can flow constantly without interrupting the fuse-link, is approx.  $0,7 \cdot I_n$ .

Regarding influences of ambient air temperatures  $> 23^\circ\text{C}$  on the rated current see pos. 14.

## \* IEC-Publikationen mit neuem Nummern-System

1997 hat IEC ein neues Nummernsystem für alle neuen und bestehenden Normen und Publikationen eingeführt. Zum Beispiel, IEC 127-1 heisst neu IEC 60127-1.

## 6. Nennspannung (auch Bemessungsspannung) $U_n$

Die Spannung, bis zu der der Sicherungseinsatz einen Überstrom einwandfrei unterbricht.

Die Nennspannung des Sicherungseinsatzes muss gleich oder grösser als die Betriebsspannung des zu schützenden Gerätes sein.

Der Einsatz bei Betriebsspannungen unterhalb der Nennspannung des Sicherungseinsatzes ist zulässig, sofern die Hinweise bei Pos. 8 / Spannungsfall berücksichtigt werden.

Die Sicherungseinsätze sind grundsätzlich für die Verwendung bei Wechsel- und Gleichspannung geeignet. Das Ausschaltvermögen bei Gleichspannung ist jedoch wesentlich kleiner als dasjenige bei Wechselspannung. Das Verhalten des Sicherungseinsatzes bei Gleichspannung wird überwiegend von der Grösse der Zeitkonstante  $\tau = \frac{1}{R}$  des zu unterbrechenden Stromkreises bestimmt.

## 7. Nennstrom $I_n$ (auch Bemessungsstrom)

Der Nennstrom des Sicherungseinsatzes entspricht dem Betriebsstrom des zu schützenden Gerätes. Es existieren grundsätzlich zwei verschiedene Nennstrom-Definitionen:

- Bei Sicherungseinsätzen nach IEC 60127 und EN 60127 entspricht der Nennstrom demjenigen Strom, mit dem der Sicherungseinsatz unter normierten Bedingungen dauernd belastet werden kann, ohne dass der Sicherungseinsatz unterbricht.
- Bei Sicherungseinsätzen nach UL 248-14 hingegen entspricht der Nennstrom demjenigen Strom, der nach einigen Stunden bereits den Sicherungseinsatz unterbricht. Der Strom, der wie bei IEC dauernd fließen darf, ohne dass der Sicherungseinsatz unterbricht, beträgt etwa  $0,7 \cdot I_n$ .

Einfluss von Umgebungstemperaturen  $> 23^\circ\text{C}$  auf den Nennstrom siehe Pos 14.

Correlation between the rated current of fuse-links according to IEC and UL:

Zusammenhang zwischen den Nennströmen von Sicherungseinsätzen nach IEC und UL:

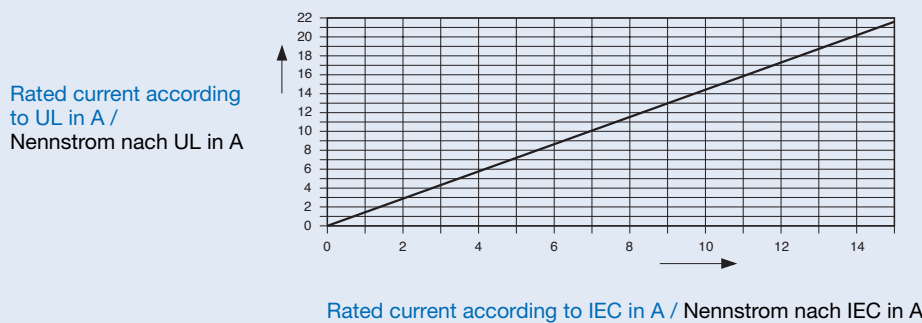

## 8. Voltage drop

The voltage drop across a fuse-link is measured at an ambient air temperature of  $23^\circ\text{C}$ , when the fuse-link has carried its rated current for a time sufficient to reach temperature stability.

Attention is drawn to the fact that problems can arise when fuse-links are used at operating voltages considerably lower than their rated voltage. Due to the increase of the voltage drop when the element of a fuse-link approaches its melting point, care should be taken to ensure that there is sufficient circuit voltage available to cause the fuse-link to interrupt the current when an electrical fault occurs. Furthermore, fuse-links of the same type and rating may, due to difference in design or element material, have different voltage drops and may therefore not be interchangeable in practice when used in applications with low circuit voltages, especially in combination with fuse-links of lower rated currents.

## 8. Spannungsfall

Der Spannungsfall über dem Sicherungseinsatz wird gemessen bei einer Umgebungstemperatur von  $23^\circ\text{C}$ , nachdem der Sicherungseinsatz mit seinem Nennstrom bis zur Erreichung der Beharrungstemperatur belastet worden ist.

Es ist darauf zu achten, dass es problematisch werden kann, wenn Sicherungseinsätze bei Betriebs-Spannungen verwendet werden, die wesentlich kleiner sind als ihre Nennspannung. Aufgrund der Tatsache, dass der Spannungsfall an einem Schmelzleiter vor Erreichen seines Schmelzpunktes beträchtlich ansteigt, muss darauf geachtet werden, dass genügend Spannung zur Verfügung steht, damit im Fehlerfall der Sicherungseinsatz den Strom einwandfrei unterbrechen kann. Darüber hinaus können Sicherungseinsätze der gleichen Charakteristik und mit den gleichen Nennwerten, die in der Ausführung oder im Schmelzleiterwerkstoff voneinander abweichen, einen unterschiedlichen Spannungsfall aufweisen. Sie sind in der Praxis nicht gegeneinander austauschbar, wenn sie in Schaltungen mit kleinen Spannungen verwendet werden. Dies gilt insbesondere für Sicherungseinsätze mit kleineren Nennströmen.

## 9. Non fusing current $I_{nr}$

A value of an over-current specified as that which the fuse-link is capable of carrying for a specified time (typical 1 hour) without melting.

## 10. Pre-arcing time/current characteristic (at $T_a$ 23 °C)

The time-current-characteristic indicates the relation of the pre-arcing time (melting time) to the fault current.

The pre-arcing time is the interval of time between the beginning of a current large enough to cause a break in the fuse-element and the instant when an arc is initiated.

The arcing time is the interval of time between the instant of the initiation of the arc and the instant of final arc extinction. The arcing time is not considered in the time-current-characteristic.

The operating time (total clearing time) is the sum of the pre-arcing time and the arcing time.

The time-current-characteristics are shown as an envelope for all mentioned rated currents.

Usual time-current-characteristic and their symbols:

FF: denoting very quick acting  
 F: denoting quick acting  
 M: denoting medium time-lag  
 T: denoting time-lag  
 TT: denoting long time-lag

UL fuse-links are normally divided into:

- Non Time Delay fuse-links. These fuse-links are sometimes also referred to as Normal blow or Quick acting types.
- Time Delay fuse-links. These fuse-links are sometimes also referred to as Slow blow or Surge proof types.

Application notes for the various characteristics:

FF: Super-quick-acting fuse-links

Protection of semiconductors (thyristors, triacs, diodes).

This fuse type tolerates small overcurrents only during a short period of time and limits the current at small short circuit currents. Current limiting even with low short circuit currents.

F: Quick-acting fuse-links

Protection of semiconductors and of an equipment with no current surge when operating or switching on and also for such devices where high overcurrent or high short-circuit current must be interrupted quickly.

M: Medium time lag fuse-links

Protection devices subjected to moderate in-rush currents and/or overcurrent peaks for a short time. Low voltage drop.

T: Time-lag fuse-links

Protection of devices subjected to high in-rush currents and/or overcurrent peaks which decrease only slowly (e.g. transformers and motors).

TT: Super time-lag fuse-links

Protection of devices subjected to longer lasting in-rush currents and/or high overcurrent peaks.

## 11. Breaking capacity of a fuse-link (UL: interrupting rating IR)

A value (r.m.s. for alternating current) of prospective current that a fuse-link is capable of breaking at a stated voltage under prescribed conditions of use and behaviour.

The max. short-circuit current, which can occur in electric circuit of an equipment, due to fault conditions, may not exceed the breaking capacity of the fuse-link. Non-compliance of this rule can cause the danger of explosions and fire.

At direct current the breaking capacity of a fuse-link is lower than at alternating current. Values are given on request.

IEC 60127 miniature fuse-links are classified into two categories (for sub-miniature fuse-links other breaking capacities are defined).

Fuse-links with Low Breaking Capacity, symbol L.

Typically, the fuse-element of this type of fuse-link is visible. The insulation tube consists of transparent material, normally glass. There is no extinguishing medium, the arc is quenched in air.

The breaking capacity is:

250 VAC/35A or  $10 \cdot I_n / p.f.1$  whichever is greater.

Fuse-links with High Breaking Capacity, symbol H.

## 9. Kleiner Prüfstrom $I_{nr}$

Überstrom, den ein Sicherungseinsatz während einer festgelegten Zeit (typisch 1 Stunde) führen kann ohne zu unterbrechen.

## 10. Zeit-Strom-Charakteristik (bei $T_u$ 23°C)

Die Zeit-Strom-Charakteristik gibt die Abhängigkeit der Schmelzzeit als Funktion des Fehlerstromes an.

Die Schmelzzeit ist die Dauer zwischen dem Augenblick, in dem ein Strom, der ausreicht, ein Unterbrechen des Schmelzleiters zu bewirken, zu fließen beginnt und dem Augenblick, in dem der Lichtbogen einsetzt.

Die Lichtbogenzeit, die Zeit zwischen dem Zünden bis zum Erlöschen des Lichtbogens, wird in der Zeit-Strom-Charakteristik nicht berücksichtigt.

Die Ausschaltzeit entspricht der Summe von Schmelz- und Lichtbogenzeit.

Die Zeit-Strom-Kennlinien sind meistens in Form von Hüllkurven für den gesamten angegebenen Nennstromstufenbereich dargestellt.

Übliche Zeit-Strom-Charakteristika und deren Abkürzungen:

FF für superflink  
 F für flink  
 M für mittelträge  
 T für träge  
 TT für superträge

UL Sicherungseinsätze werden üblicherweise unterteilt in:

- Non Time Delay Sicherungseinsätze, auch bekannt als Normal Blow oder Flink.
- Time Delay Sicherungseinsätze, auch bekannt als Slow Blow oder Surge proof.

Anwendungs-Hinweise für die verschiedenen Charakteristika:

FF: superflinke Sicherungseinsätze

Zum Schutz von Halbleitern (Thyristoren, Triacs, Dioden). Strombegrenzung schon bei kleinen Kurzschluss-Strömen.

F: flinke Sicherungseinsätze

Zum Schutz von Halbleitern und Geräten, bei denen beim Einschalten oder im Betrieb keine Stromstösse auftreten, aber hohe Über- oder Kurzschluss-Ströme in kürzester Zeit unterbrochen werden sollen.

M: mittelträge Sicherungseinsätze

Zum Schutze von Geräten vor mässigen Einschalt- und Überstromspitzen während kurzer Zeit. Niedriger Spannungsfall.

T: träge Sicherungseinsätze

Zum Schutz von Geräten vor hohen, nur langsam abklingenden Einschalt- und Überstromspitzen, z. B. Transformatoren und Motoren.

TT: superträge Sicherungseinsätze

Zum Schutz von Geräten vor hohen, längerdauernden Einschalt- und Überstromspitzen.

## 11. Ausschaltvermögen eines Sicherungseinsatzes

Der Wert (Effektivwert für Wechselstrom) des unbeeinflussten Stromes, den ein Sicherungseinsatz bei einer festgelegten Spannung unter festgelegten Bedingungen ausschalten kann.

Der max. Kurzschluss-Strom, der unter Fehlerbedingungen in einem Geräte-Stromkreis auftreten kann, darf das Ausschaltvermögen des Sicherungseinsatzes nicht überschreiten. Bei Nichteinhaltung dieser Bedingung besteht Explosions- und Brandgefahr.

Bei Gleichstrom ist das Ausschaltvermögen eines Sicherungseinsatzes niedriger als bei Wechselstrom. Werte auf Anfrage.

IEC 60127 unterscheidet bei G-Sicherungseinsätzen folgende zwei Kategorien. (Für Kleinst-Sicherungseinsätze wurden andere Schaltvermögen definiert.)

Sicherungseinsätze mit kleinem Schaltvermögen, Symbol L:

Der Schmelzleiter dieser Sicherungseinsätze ist normalerweise sichtbar. Das Isolierrohr besteht aus transparentem Material, z. B. Glas. Der Sicherungseinsatz enthält kein lichtbogenlöschendes Medium.

Das Schaltvermögen beträgt:

250 V AC/35 A oder  $10 \cdot I_n / \cos \varphi$  1, je nachdem welcher Wert grösser ist.

Sicherungseinsätze mit hohem Schaltvermögen, Symbol H:

## FUSES / SICHERUNGEN

## NON RESETTABLE / NICHT RÜCKSTELLEND

Typically, the fuse-element of this type of fuse-link is not visible. The insulation tube normally is of ceramic material or glass. To quench the arc, there is often an extinguishing medium.

The breaking capacity is:  
250 VAC/1500A/p.f. 0.7 to 0.8

UL's and CSA's short circuit requirements (interrupting rating IR) are different as relates to IEC.

Interrupting ratings at  $\left. \begin{array}{l} 125 \text{ VAC} = 10'000 \text{ A} \\ 250 \text{ VAC} = 35 \text{ to } 1500 \text{ A} \end{array} \right\} \text{ p.f. } 0,7-0,8$   
depending on rated current of the fuse-link.

### 12. Power dissipations

#### 12.1 Max. sustained power dissipation

a) Fuse-links according to IEC 60127:

The test is carried out according to a standardised test procedure (open fuse-holder, room temperature).

The power dissipation produced by the non fusing current  $I_{nf}$  after one hour is determined.

Non fusing currents are different and depend on the fuse-link type.

In the SCHURTER catalogue you will usually find two values of sustained power dissipation, namely:

- the maximum sustained power dissipation i.e. according to IEC 60127.
- The typical sustained power dissipation of the SCHURTER fuse-links. These values are mostly lower than the standardised ones.

b) Fuse-links according to UL 248-14:

UL does not, like IEC, determine the sustained power dissipation, but measures the maximum permissible temperature increase from 75 °C at  $1 \cdot I_n$  on the outer surface of the fuse-link according to the UL standard.

#### 12.2 Rated power dissipation

The power dissipation caused by the rated current (over a long period). With respect to the power acceptance for the selection of a suitable fuseholder this rated power dissipation is considered.

### 13. $I^2t$ -value (joule integral)

The integral of the square of the current over a given time interval. The  $I^2t$ -value is a measure of the energy required to disrupt the fuse-link. That means for heating up the fuse-element to its melting temperature, for melting the fuse-element and for interruption of the current via an arcing period. Normally, distinction is made between.

- the pre-arcing  $I^2t$  (or fusing  $I^2t$ )  
is the  $I^2t$  integral extended over the pre-arcing time of the fuse-link. It represents the energy for heating up and melting the fuse-element. At high over-currents with melting times <10 ms the pre-arcing  $I^2t$  remains constant (adiabatic conditions). Sometimes the pre-arcing  $I^2t$  is determined by 10.times the rated current, based on the time-current-characteristic. The pre-arcing  $I^2t$  is a characteristic value of a fuse-link and informs about his resistance to pulses and in-rush-currents.
- the arcing  $I^2t$   
is the  $I^2t$  integral extended over the arcing time of the fuse-links. It represents the arc-energy. The arcing  $I^2t$  depends on the electrical circuit parameters (e.g. operation voltage, power factor, closing angle etc.) of an electrical circuit.
- The operating  $I^2t$  (or: total  $I^2t$ )  
is the sum of pre-arcing and arcing  $I^2t$ . This value is an important parameter for the application of a fuse-link. It characterises the energy exposed to the object (let-through-energy) to be protected by the fuse-link in case of a fault current.

Application notes:

In order to choose the right fuse-link, the permitted  $I^2t$ -value of the component or component group to be protected, has to be known.

Der Schmelzleiter dieser Sicherungseinsätze ist normalerweise nicht sichtbar. Das Isolierrohr besteht meistens aus Keramik oder Glas. Der Sicherungseinsatz enthält in der Regel ein lichtbogenlöschendes Medium.

Das Schaltvermögen beträgt:  
250 V AC/1500 A/cos  $\varphi$  0.7 bis 0.8

UL's and CSA's Anforderungen betreffend Schaltvermögen (Interrupting Rating IR) sind im Vergleich mit IEC verschieden.

Schaltvermögen bei  $\left. \begin{array}{l} 125 \text{ V AC} = 10000 \text{ A} \\ 250 \text{ V AC} = 35 \text{ bis } 1500 \text{ A} \end{array} \right\} \text{ cos } \varphi \text{ } 0,7-0,8$   
je nach Nennstrom des Sicherungseinsatzes.

### 12. Verlustleistungen

#### 12.1 Max. Verlustleistung

a) Sicherungseinsätze nach IEC 60127:

Die Prüfung erfolgt nach einem standardisierten Prüfverfahren (offener Sicherungshalter, Raumtemperatur).

Es wird die Verlustleistung ermittelt, die durch den kleinen Prüfstrom  $I_{nf}$  nach einer Stunde erzeugt wird.

Die Überströme  $I_{nf}$  sind je nach Sicherungseinsatz-Typ verschieden.

Im SCHURTER Katalog finden Sie in der Regel zwei Verlustleistungswerte nämlich:

- die max. zulässige Verlustleistung nach Norm, z.B. IEC 60127
- die typische Verlustleistung der SCHURTER Sicherungseinsätze. Diese Werte sind meistens niedriger als die normierten.

b) Sicherungseinsätze nach UL 248-14:

UL ermittelt nicht wie IEC die Verlustleistung, sondern die in der UL-Norm festgelegte maximal zulässige Temperaturerhöhung von 75 °C bei  $1 \cdot I_n$  an den äusseren Oberflächen des Sicherungseinsatzes.

#### 12.2 Nenn-Verlustleistung

Die Verlustleistung, die bei Nennstrom erzeugt wird (während einer langen Zeit). Für die Auswahl des richtigen G-Sicherungshalters in bezug auf seine Leistungsaufnahme wird diese Nenn-Verlustleistung berücksichtigt.

### 13. $I^2t$ -Wert (Joule-Integral)

Das Integral des Stromes im Quadrat über eine gegebene Zeitspanne. Der  $I^2t$ -Wert ist ein Mass für die Energie, welche im Fehlerfall notwendig ist, den Sicherungseinsatz zu unterbrechen, d.h. für das Aufheizen und Schmelzen des Schmelzelementes und das Unterbrechen des Stromes in der Lichtbogenperiode. Man unterscheidet zwischen drei verschiedenen  $I^2t$ -Werten:

- der Schmelz- $I^2t$ -Wert  
ist das  $I^2t$ -Integral über der Schmelzdauer des Sicherungseinsatzes. Er entspricht der Energie für das Aufheizen und Schmelzen des Schmelzelementes. Bei hohen Strömen mit Schmelzzeiten <10 ms ist der Schmelz- $I^2t$ -Wert eine Konstante (adiabatischer Zustand). Häufig wird der Schmelz- $I^2t$ -Wert beim 10fachen Nennstrom festgelegt, basierend auf der Zeit-Strom-Charakteristik. Der Schmelz- $I^2t$ -Wert ist ein kennzeichnender Wert eines Sicherungseinsatzes und informiert über dessen Impulsfestigkeit.
- der Lichtbogen- $I^2t$ -Wert  
ist das  $I^2t$ -Integral über der Lichtbogendauer des Sicherungseinsatzes. Er entspricht der Lichtbogenenergie. Der Lichtbogen- $I^2t$ -Wert hängt ab von den Parametern des Stromkreises (z. B. Betriebsspannung, cos  $\varphi$ , elektr. Einschaltwinkel usw.)
- der Ausschalt- $I^2t$ -Wert (Total  $I^2t$ -Wert)  
ist das  $I^2t$ -Integral über der Ausschaltdauer des Sicherungseinsatzes (Summe von Schmelz- und Lichtbogen- $I^2t$ -Wert). Er ist ein wichtiger Parameter für die Anwendung von Sicherungseinsätzen. Er kennzeichnet die Energie, die ein zu schützendes Objekt im Fehlerfall ausgesetzt wird.

Anwendungs-Hinweise:

Für die Wahl des richtigen Sicherungseinsatzes muss der zulässige  $I^2t$ -Wert des zu schützenden Bauteiles oder -gruppe bekannt sein.

Selection criteria: The electric circuit to be protected contains:

- Components, which can cause in-rush currents, e.g. transformers. In this case, a fuse-link has to be chosen with a pre-arcing I<sup>2</sup>t-value which is higher than the one of the in-rush-current.
- Components, which are sensitive to current impulses, e.g. semi-conductors. In this case a fuse-link has to be chosen, with an operating I<sup>2</sup>t-value which is lower than the one of the components to be protected.

## 14. Ambient air temperatures

The standardised current carrying capacity tests (IEC and UL) of fuse-links are performed at 23 °C and 25 °C respectively. In practical applications, the fuse-link's ambient temperature may be significantly higher, especially if the fuse-link is used in an unexposed fuseholder or mounted near other heat generating components. For such applications, the shift of the operating current according to the following diagram has to be considered.

Auswahlkriterien: Der zu schützende Stromkreis enthält

- Bauelemente, die Einschaltstromstösse verursachen können, z. B. Transformatoren. In diesem Fall soll ein Sicherungseinsatz gewählt werden, dessen Schmelz-I<sup>2</sup>t-Wert grösser ist als derjenige des Einschaltstromstosses.
- Bauelemente, die empfindlich sind auf Stromstösse, z.B. Halbleiter. In diesem Fall soll ein Sicherungseinsatz gewählt werden, dessen Ausschalt-I<sup>2</sup>t-Wert kleiner ist als derjenige des zu schützenden Bauelementes.

## 14. Umgebungstemperaturen

Die standardisierten Prüfungen für Sicherungseinsätze (IEC und UL) werden durchgeführt bei 23 °C resp. 25 °C. In der Praxis werden die Umgebungstemperaturen jedoch wesentlich höher sein, insbesondere da, wo der Sicherungseinsatz in einem geschlossenen Sicherungshalter eingesetzt ist oder in der Nähe von anderen, Wärme produzierenden Bauteilen. Bei solchen Anwendungsfällen ist daher die Verschiebung des Betriebsstromes gemäss dem folgenden Diagramm zu berücksichtigen.

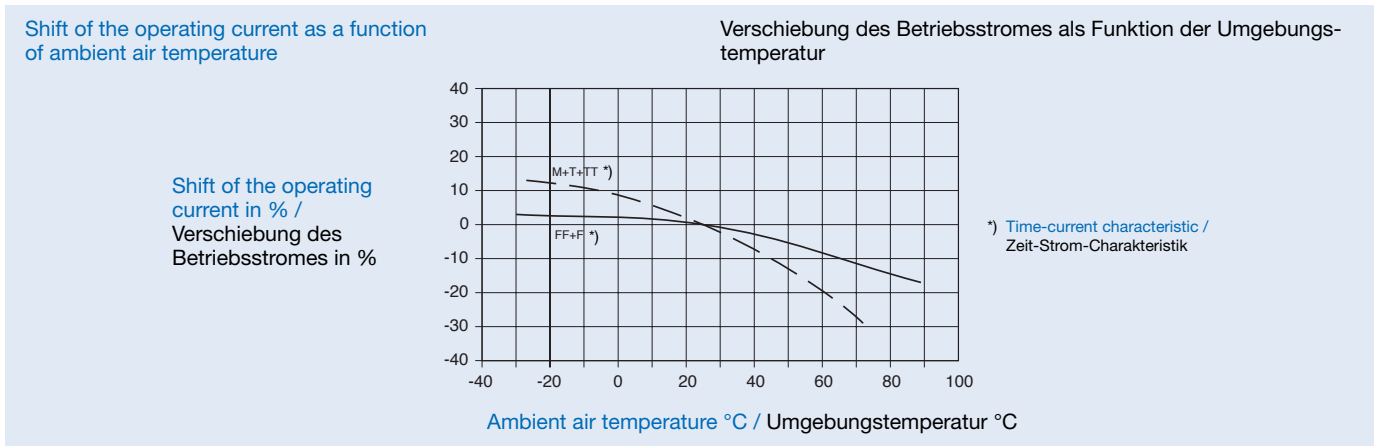

## 15. Marking of the fuse-links

Marking according to IEC 127

Example: T 200 mA L 250 V 

T: symbol, denoting the relative pre-arcing time-current-characteristic  
 200 mA: rated current in mA or A  
 L: symbol, denoting the rated breaking capacity  
 250 V: rated voltage in V  
: Schurter Logo

Additional marking: approval marks

## 15. Kennzeichnung der Sicherungseinsätze

Kennzeichnung gemäss IEC

Beispiel: T 200 mA L 250 V 

T: Kennbuchstabe der entsprechenden Strom-Zeit-Charakteristik  
 200 mA: Nennstrom in mA oder A  
 L: Kennbuchstabe des Schaltvermögens  
 250 V: Nennspannung in V  
: Schurter Logo

Zusätzliche Kennzeichnung: Prüfzeichen

## 16. Interchangeability of IEC- by UL fuse-links and Vice Versa

Fuse-links according to IEC und UL have different features and are on principle not interchangeable. However, after a thorough check of the technical data it may be possible to interchange, when the following, most important requirements are met.

- The rated currents must be adapted (see pos.7)
- The breaking capacity must be compatible.
- The time-current characteristic and voltage drop must be roughly the same.

## 16. Austausch von IEC- durch UL Sicherungseinsätze und umgekehrt

Sicherungseinsätze nach IEC und UL weisen unterschiedliche Eigenschaften auf und sind grundsätzlich nicht austauschbar. Bei sorgfältiger Überprüfung der technischen Daten ist ein Austausch jedoch möglich, sofern die folgenden, wichtigsten Anforderungen erfüllt werden.

- Die Nennströme müssen angepasst werden (siehe Pos. 7)
- Das Schaltvermögen muss übereinstimmen.
- Die Zeit-Strom-Charakteristik und der Spannungsfall sollen ungefähr übereinstimmen.

## 17. Exchange of fuse-links under load

A fuseholder with an installed fuse-link shall not be used as a «switch» for turning power «on» and «off».

An opening and closing of electric-circuits may cause current- and voltage surges, depending on the dimension of the electric circuit. Such current or voltage peaks produce an arc between the contact points, which causes an increase of the contact resistance. In order to prevent the fuseholder from permanent damage, a fuse-link shall only be exchanged when power in an electric circuit is switched off.

## 17. Auswechseln von Sicherungseinsätzen unter Last

Ein Sicherungshalter mit einem eingesetzten Sicherungseinsatz darf nicht als Schalter zum Ein- und Ausschalten eines Stromkreises verwendet werden.

Beim Öffnen bzw. Schliessen eines Stromkreises treten, je nach Dimensionierung des Stromkreises, Strom- und Spannungserhöhungen auf. Diese Strom- bzw. Spannungsspitzen erzeugen an der unterbrechenden oder schliessenden Kontaktstelle einen Lichtbogen, der undefinierte Übergangswiderstände an der Kontaktstelle verursacht.

### 18. Quality assessment of fuse-links

SCHURTER fuse-links meet with the requirements according to IEC 60127-5 and EN 60127-5.

More detailed information is available on request.

### 19. Reliability of SMT-Fuse-links

The statistical reliability data are based on standardized long-term and life time tests with SCHURTER SMT fuse links.

The tests have been executed according to Mil-HDBK-217F.

Reliability data for an individual SMT type are available on request.

## Fuse-link selection guide

1. The operating voltage  $U_B$  of the equipment to be protected defines the rated voltage  $U_N$  of the fuse-link (see pos. 6)  $U_N \geq U_B$ . For  $U_B \ll U_N$  please refer to the remarks regarding voltage drop (see pos. 8).
2. The max. operating current of the equipment to be protected defines the rated current of the fuse-link. The different definitions for rated current according to IEC or UL as well as the influence of higher ambient temperatures are to be taken into consideration (pos. 6 and 14).
3. The possible fault current as well as its permitted operating times in the electric circuit of the equipment to be protected define the time-current-characteristic of the fuse-link (see pos. 10).
4. The necessary breaking capacity of the fuse-link depends on the max. short-circuit current, which can occur under fault conditions in the electric circuit of the equipment to be protected. It must be lower than the max. current which can be interrupted by the fuse-link. (see pos. 11)
5. The rated power dissipation of the fuse-link is of importance for the selection of the suitable fuseholder (see pos. 12.2).
6. If current impulses occur in the electric circuit of the equipment to be protected, which may not interrupt the fuse-link under any circumstances or if the let-through-energy of the fuse-link may only reach a certain value (eg. protection of semi-conductors) the  $I^2t$  values have to be taken into consideration accordingly (see pos. 13).
7. The necessary approvals are mostly defined by national and international standards for equipment. SCHURTER fuse-links are according to international standards and were approved by the different agencies (refer to data sheets for the individual fuse-links).
8. It is essential that the selected fuse-links/fuse-holders that are fitted to the equipment to be protected, are being tested under normal and fault conditions, even if all relevant criteria for selection have been taken into consideration.

Um bleibende Schäden am Sicherungshalter zu vermeiden, soll ein Sicherungseinsatz nur in einem bereits unterbrochenen Stromkreis gewechselt werden.

### 18. Qualitätsanforderungen

SCHURTER Sicherungseinsätze erfüllen die Anforderungen nach IEC 60127-5 und EN 60127-5.

Detail-Angaben sind auf Anfrage erhältlich.

### 19. Zuverlässigkeit von SMT-Sicherungseinsätzen

Die statistischen Zuverlässigkeitsangaben basieren auf standardisierten Langzeitversuchen sowie Life-Tests mit SCHURTER SMT-Sicherungseinsätzen. Diese Versuche wurden in Anlehnung an Mil-HDBK-217F durchgeführt. Zuverlässigkeitsdaten für die einzelnen SMT-Typen sind auf Anfrage erhältlich.

## Leitfaden zur Sicherungseinsatz-Auswahl



1. Die Betriebsspannung  $U_B$  des zu schützenden Gerätes bestimmt die Nennspannung  $U_N$  des Sicherungseinsatzes (siehe Pos. 6)  $U_N \geq U_B$ . Bei  $U_B \ll U_N$  sind besonders die Bemerkungen zum Spannungsfall (siehe Pos. 8) zu beachten.
2. Der max. Betriebsstrom des zu schützenden Gerätes bestimmt den Nennstrom des Sicherungseinsatzes. Die unterschiedlichen Nennstrom-Definitionen nach IEC bzw. UL sowie der Einfluss höherer Umgebungstemperaturen sind hierbei zu beachten (Pos. 6 und 14).
3. Die möglichen Fehlerströme sowie deren zulässige Ausschaltzeiten im Stromkreis des zu schützenden Gerätes bestimmen die Zeit-Strom-Charakteristik des Sicherungseinsatzes (siehe Pos. 10)
4. Das notwendige Ausschaltvermögen des Sicherungseinsatzes richtet sich nach dem max. Kurzschlussstrom, der unter Fehlerbedingungen im Stromkreis des zu schützenden Gerätes auftreten kann. Er muss kleiner sein als der max. Strom den der Sicherungseinsatz sicher unterbrechen kann (siehe Pos. 11).
5. Die Nenn-Verlustleistung des Sicherungseinsatzes ist insbesondere für die Auswahl des passenden Sicherungshalters von Wichtigkeit (siehe Pos. 12.2).
6. Treten im Stromkreis des zu schützenden Gerätes Stromimpulse auf, die den Sicherungseinsatz nicht unterbrechen dürfen oder darf die Durchlassenergie des Sicherungseinsatzes nur einen bestimmten Wert erreichen (z. B. Schutz von Halbleitern), so sind die  $I^2t$ -Werte gebührend zu berücksichtigen (siehe Pos. 13).
7. Die notwendigen Approbationen werden im wesentlichen von nationalen und internationalen Gerätevorschriften bestimmt. Sicherungseinsätze von SCHURTER entsprechen internationalen Vorschriften und sind von verschiedenen Prüfstellen approbiert (siehe Datenblätter der einzelnen Sicherungseinsätze).
8. Auch bei Beachtung aller relevanten Auswahlkriterien ist es generell erforderlich, die ausgewählten Sicherungseinsätze/Sicherungshalter im zu schützenden Gerät unter Normal- und Fehlerbedingungen zu überprüfen.

# SELECTOR CHART ÜBERSICHT

## FUSES SICHERUNGEN

## NON RESETTABLE NICHT RÜCKSTELLEND

## SUB-MINIATURE FUSE-LINKS / KLEINST-SICHERUNGSEINSÄTZE

		for surface mounting / für Oberflächenmontage						
Dimensions / Abmessungen		Standard size 1206 / Standardgrösse 1206 4,5 x 2,6 x 1,9 mm						
			<b>NEW</b> <b>NEU</b>	<b>SUPRAFUSE</b> Classic	with clip / mit Haltefeder	<b>SUPRA</b> <b>FUSE</b> *	<b>SUPRAFUSE</b> Chippguard	with clip / mit Haltefeder
		3,05 x 1,52 x 1,52 mm						
Breaking capacity / Ausschaltvermögen depending on rated current/approval / abhängig von Nennstrom/Approbationen		50 A / 125 V / 32 V AC 300 A / 125 V / 32 V DC		50 A / 125 V				
Pre-arcing time/current characteristic / Zeit-Strom-Charakteristik		FF		F		FF		FF
super-quick acting / superflink								
quick acting / flink								
time-lag / träge								
Standards / Normen		UL 248-14 CSA C22.2/No 248.14		IEC 60127-4/2 EN 60127-4/2 UL 248-14 CSA C22.2/No 248.14		UL 248-14 CSA C22.2/No 248.14		
Rated voltages / Nennspannungen		125 V / 32 V		125 V		125 V		63 V
Rated currents / Nennströme		0,2-5 A		0,8-4 A		0,8-4 A		1-5 A
SCHURTER Type / Typ		MGA		SFC 125 V				SFP 63 V
CEHESS-SCHURTER Type / Typ								
Approvals / Approbationen Techn. data / Techn. Daten Order nos. / Bestell-Nr.		see page / siehe Seite <b>50</b>		<b>52</b>		<b>52</b>		<b>53</b> <b>53</b>
Suitable fuseholder, see page / Passende Sicherungshalter siehe Seite								

		with wire leads / mit Drahtanschlüssen						
Dimensions / Abmessungen		Ø 2,54 x 2,54 x 7 mm		Ø 6,4 x 8,8 mm		Ø 8,5 x 8,5 mm		
			<b>NEW</b> <b>NEU</b>					
Breaking capacity / Ausschaltvermögen depending on rated current/approval / abhängig von Nennstrom/Approbationen		300 A / 125 V		50 A / 125 V		UL/CSA: 300 A / 125 V AC/DC (IEC: 50 A/125 V AC/DC)		35 A or / oder 10 · I <sub>n</sub> / 250 V AC
Pre-arcing time/current characteristic / Zeit-Strom-Charakteristik		F		T		F		T
super-quick acting / superflink								
quick acting / flink								
time-lag / träge								
Standards / Normen		UL 248-14		IEC 60127-4/2 EN 60127-4/2		IEC 60127-3/1 EN 60127-3/1 UL 248-14 CSA C22.2/No 248.14		IEC 60127-3/3 EN 60127-3/3 UL 248-14 CSA C22.2/No 248.14
Rated voltages / Nennspannungen		125 V		125 V		125 V		250 V
Rated currents / Nennströme		0,125 - 7 A		2 - 6,3 A		50 mA - 5 A		40 mA - 5 A
SCHURTER Type / Typ		MKF		MKT		Microfuse MSF 125		Microfuse MSF 250
CEHESS-SCHURTER Type / Typ								Microfuse MST 250
Approvals / Approbationen Techn. data / Techn. Daten Order nos. / Bestell-Nr.		see page / siehe Seite <b>64</b>		<b>65</b>		<b>67</b>		<b>68</b> <b>69</b>
Suitable fuseholder, see page / Passende Sicherungshalter siehe Seite						 189		 191



for surface mounting / für Oberflächenmontage

7,4 x 3,1 x 2,55 mm

7,4x3,1x2,55 mm

11 x 4,6 x 3,9 mm

Ø 2 x 7 mm



Fuseholder OMH 125 with pre-inserted fuse link OMF 63 / Si-Halter OMH 125 mit eingezettem Si-Einsatz OMF 63

Fuseholder OMH 125 with pre-inserted fuse-link OMF125 / Si-Halter OMH 125 mit eingezettem Si-Einsatz OMF 125

**NEW**  
**NEU**

**NEW**  
**NEU**

50 A / 63 V

300 A / 125 V AC  
400 A / 125 V DC

100 A / 250 V AC  
p. f. / cos w 1  
100 A / 250 V DC

300 A / 125 V

50 A / 125 V AC/DC

F	F	F	F	F		F	T	
UL 248-14 CSA C22.2/ No 248.14		UL 248-14 CSA C22.2/ No 248.14		IEC 60127-4/2 EN 60127-4/2 UL 248-14 CSA C22.2/No 248.14		UL 248-14 CSA C22.2/ No 248.14	UL 248-14 CSA C22.2/ No 248.14	IEC 60127-4/2 EN 60127-4/2
63 V	63 V	125 V	125 V	250 V		250 V	125 V	125 V
63 mA-10A	63 mA - 5 A	63 mA - 10 A	63 mA - 5 A	0,25 - 4 A		0,75-5 A	0,125 - 7 A	2 - 6,3 A
OMF 63	OMK 63	OMF 125	OMK 125	OMF 250		OMT 250		
							172876	MSB
<b>55</b>	<b>60</b>	<b>56</b>	<b>60</b>	<b>57</b>		<b>58</b>	<b>62</b>	<b>63</b>



193



193



188

Ø 8,5 x 8,5 mm	Ø 2,36 x 8 mm			Ø 2,16 x 3,3 mm	12 x 8 x 5 mm	Special fuses / Spezialsicherungen	
	*formerly type MSA / *früherer Typ MSA			Space application Raumsicherung- Anwendungen		Fuse with signal contact and visual indicator Sicherung mit Signalkontakt und optischer Anzeige	
100 A / 250 V AC (IEC: 35 A or / oder 10 · I <sub>n</sub> / 250 V AC)	300 A / 125 V (300 A / 32 V)	300 A / 125 V (300 A / 32 V)		50 A/125 V/32 V AC 300 A/125 V/32 V AC	100 A / 250 V AC	50 A / 125 V	
				FF			
T	F	F	F		F	T	F
	IEC 60127-3/2 EN 60127-3/2 UL 248-14 CSA C22.2/No 248.14	NF C 93-435 Modell HA 81	Draft ESA-SCC 4008	UL 248-14 CSA C22.2/ No 248.14	IEC 60127-4/1 EN 60127-4/1		
250 V	125 V / 32 V	125 V / 32 V	125 V / 32 V	125 V / 32 V	250 V	250 V	125 V
0,8 - 6,3 A	1/16 - 15 A	1/16 - 15 A	1/8 - 15 A	0,2 - 5 A	0,25 - 6,3 A		1 - 5 A
Microfuse MXT 250				MGL			
	*172322	172321	172321S		FRT 250 F	FRT 250 T	PSC
<b>70</b>	<b>72</b>	<b>74</b>	<b>76</b>	<b>77</b>	<b>78</b>	<b>79</b>	<b>81</b>
					192		188



Fuse kits see pages 82, 83 /  
Sicherungsordnungsboxen siehe Seiten 82, 83

# SELECTOR CHART ÜBERSICHT



## FUSES SICHERUNGEN

## NON RESETTABLE NICHT RÜCKSTELLEND

## MINIATURE FUSE-LINKS / G-SICHERUNGSEINSÄTZE

<b>Dimensions / Abmessungen</b>	4,7 x 16 mm		5 x 20 mm					
								
<b>Breaking capacity* / Ausschaltvermögen*</b>	low / klein	L ≙ low / klein	C, D, E ≙ low / klein medium / mittel	low / klein	low / klein medium / mittel			
<b>Insulating tube: glass G or ceramic C / Isolierrohr: Glas G oder Keramik C</b>	G	G	G	G	G	G		
<b>Pre-arcing time/current characteristic / Zeit-Strom-Charakteristik</b>								
super-quick acting / superflink								
quick acting / flink	F	F					F	
medium-time-lag / mittelträge				M				
time-lag / träge							T	
super-time-lag / superträge						TT		
<b>Standards / Normen</b>	NF C 93-435 Modell HA 35	IEC 60127-2/2 EN 60127-2/2	IEC 60127-2/3 EN 60127-2/3	DIN 41571/2			UL 248-14 CSA C22.2 No. 248.14	
<b>Rated voltages / Nennspannungen</b>	125 V	250 V	250 V	250 V	250 V	250 V	125 V / 250 V	
<b>Rated currents / Nennströme</b>	63 mA–10 A	2 mA–10 A	20 mA–20 A	315 mA–10 A	63 mA–4 A	0,4–3,5 A	0,1–3,5 A	
<b>SCHURTER Type / Typ</b>		FSF	FST	FSM	FTT	FSQ	FSD	
<b>CEHESS-SCHURTER Type / Typ</b>	DO							
<b>Approvals / Approbationen Techn. data / Techn. Daten Order nos. / Bestell-Nr.</b>	see page / siehe Seite	<b>84</b>	<b>85</b>	<b>86</b>	<b>87</b>	<b>88</b>	<b>89</b>	<b>90</b>

\*Note: depending on rated current/approval / \* Hinweis: abhängig von Nennstrom/Approbationen

<b>Dimensions / Abmessungen</b>	6,3 x 32 mm (1/4" x 1 1/4")							
								
<b>Breaking capacity* / Ausschaltvermögen*</b>	L ≙ low / klein	low / klein		low / klein medium / mittel		high / gross		
<b>Insulating tube: glass G or ceramic C / Isolierrohr: Glas G oder Keramik C</b>	G	G		G		C or / oder G		
<b>Pre-arcing time/current characteristic / Zeit-Strom-Charakteristik</b>								
super-quick acting / superflink						FF		
quick acting / flink	F			F			F	
medium-time-lag / mittelträge								
time-lag / träge		T				T		
super-time-lag / superträge				TT				
<b>Standards / Normen</b>	IEC 60127-2/4 EN 60127-2/4			UL 248-14 CSA C22.2 No. 248.14				
<b>Rated voltages / Nennspannungen</b>	250 V	250 V	250 V	125 V/250 V	125 V/250 V	250 V	250 V	
<b>Rated currents / Nennströme</b>	0,1–10 A	20 mA–20 A	0,1–4 A	0,1–15 A	62 mA–15 A	1,6–16 A	0,5–20 A	
<b>SCHURTER Type / Typ</b>		FSF	FST	FTT	FSF	FST	SA	SP
<b>CEHESS-SCHURTER Type / Typ</b>		FSF	FST	FTT	FSF	FST	SA	SP
<b>Approvals / Approbationen Techn. data / Techn. Daten Order nos. / Bestell-Nr.</b>	see page / siehe Seite	<b>99</b>	<b>100</b>	<b>101</b>	<b>102</b>	<b>103</b>	<b>104</b>	<b>105</b>

**5 x 20 mm**

 with pigtails /  
mit Drahtanschlüssen

 with indicator /  
mit  
Kennmelder

high / gross	H $\hat{=}$ high / gross	low / klein	high / gross	low / klein	high / gross	low / klein
C	C	G	C	G	C	G

FF	F	F	F	F	F	F
	T			T	T	

**TT**

	IEC 60127-2/1 EN 60127-2/1	IEC 60127-2/5 EN 60127-2/5	NF C93-435 Modell HA 21	NF C93-435 Modell HA 20	NF C93-435 Modell HA 38		
250 V	250 V	250 V	220 V, I <sub>n</sub> $\leq$ 1,25 A 125 V, I <sub>n</sub> 1,6–6,3 A 32 V, I <sub>n</sub> > 6,3 A	(TT: 1,6–10 A) (TT: > 10 A)	250 V	250 V	250 V
1,6–10 A	0,5–16 A	0,5–16 A	20 mA–20 A	31 mA–15 A	0,16–6,3 A	see page / siehe Seite 97	0,25–10 A
SA	SP	SPT				FSF FST SP SPT	
			D1	D1TD	172581		D1V
<b>91</b>	<b>92</b>	<b>93</b>	<b>94</b>	<b>95</b>	<b>96</b>	<b>97</b>	<b>98</b>

**6,3 x 32 mm (1/4" x 1 1/4")**

high / gross	high / gross	high / gross	high / gross	high / gross
C or / oder G	C		C	C

FF	FF	FF	FF		
				F	F
T					T

**TT**

					UL 248-14 CSA C22.2 No. 248.14	NF C93-435 Modell HA 39	NF C93-435 Modell HA 24	NF C93-435 Modell HA 25
250/150 V	250 V	380 V	500 V	660 V	250 V	250 V	250 V	125 V AC/DC 220 V AC
								125 V AC/DC 220 V AC
0,5–32 A	0,1–20 A	0,1–12,5 A	0,1–12,5 A	0,1–2 A	0,125–16 A	0,125–20 A	0,16–16 A	0,16–1,25 A
1,6–16 A								
SPT	A12FA/250 V	A12FA/380 V	A12FA/500 V	A12FA/660 V	A12BK	172600	172582	D8STTD
								A12TD
<b>106</b>	<b>107</b>	<b>108</b>	<b>109</b>	<b>110</b>	<b>111</b>	<b>112</b>	<b>113</b>	<b>114</b>

 Fuse kits see page 115 /  
Sicherungsordimentskasten siehe Seite 115  
Plug-on caps with pictail see page 116 /  
Aufsteckkappen mit Drahtanschlüssen siehe Seite 116

**Sub-miniature fuse for surface mounting Type MGA super-quick-acting FF**

**NEW**

**Kleinst-Sicherung für Oberflächenmontage Typ MGA superflink FF**

**NEU**



1:1

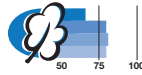

- "Flip chip" design mounts on any side
- Lowest resistance
- Very quick acting
- Hermetically sealed for operating temperatures in excess of 150 °C
- Low energy let-through
- Superior cycling

- Sicherung kann auf allen Seiten montiert werden
- Kleinster Innenwiderstand
- Superflink
- Hermetisch dicht für Einsatztemperaturen bis zu 150 °C
- Kleine Verlustleistung
- Widerstandsfähig gegenüber Umwelteinflüssen

**Approvals, Patents / Approbationen, Patente**

UL recognition 200mA-3A<sup>1)</sup> File # E153466  
 CSA acceptance 200mA-3A<sup>1)</sup> File # LR106903

<sup>1)</sup> 4A-5A approvals pending / 4A-5A in Prüfung

US 4.749.980 US 5.032.817 US 5.131.137  
 US 4.860.437 US 5.040.284 US 5.155.462  
 US 4.926.543 US 5.097.245 US 5.224.261  
 US 5.001.451 US 5.122.774 US 5.272.804  
 US 5.027.101

Patents in US. and in further countries / Patente in U. S. und weiteren Ländern

**Pre-arcing time/current characteristic (at T<sub>a</sub> 23 °C)**

**Zeit-Strom-Charakteristik (bei T<sub>u</sub> 23 °C)**

$n \cdot I_n$	$1 \cdot I_n$	$2,5 \cdot I_n$
Rated current I <sub>n</sub> / Nennstrom I <sub>n</sub>		
200 mA-5 A	≥ 4 h	≤ 5 s

**Standard 1206 SMT package size / Verpackungsgrösse**

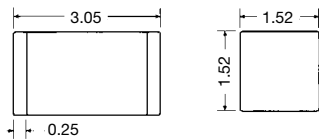

Note: dimensions are in mm / Hinweis: Dimensionen in mm

**Solder pads for wave soldering / Anschlussflächen Wellenlötlung**

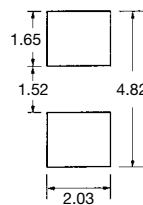

**Solder pads for infrared soldering / Anschlussflächen Infrarotlötlung**

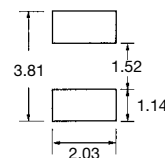

**Technical data**

Rated current see chart  
 Time current characteristic super-quick-acting  
 Interrupt capacity 50 A AC, 300 A DC  
 Ambient temperature max. + 150 °C  
 Climatic category hermetically sealed  
 Solderability reflow: 260 °C / 30 sec. max; wave 260 °C / 10 sec. max.  
 Soldering heat resistance 60 seconds above 200 °C, max. 260 °C  
 Material: Housing ceramic  
 Terminals nickel, tin-lead coated  
 Packaging 8 mm tape and reel per EIA-RS481 (equivalent to IEC 60286-3)

**Technische Daten**

Nennstrom siehe Tabelle  
 Auslösecharakteristik superflink  
 Ausschaltvermögen 50 A AC, 300 A DC  
 Max. Umgebungstemperat. + 150 °C  
 Klimakategorie hermetisch dicht  
 Lötbarkeit Reflow: 260 °C / 30 sek. max; Wellenlötlung 260 °C / 10 sek. max.  
 Lötwärmebeständigkeit 60 Sekunden über 200 °C, max. 260 °C  
 Material: Gehäuse Keramik  
 Anschluss Nickel, Zinn-Blei-Legierung  
 Verpackung 8 mm Blisterband gemäss EIA-RS481 (vergleichbar zu IEC 60286-3)

Typical Time to Trip at 23°C / Typische Auslösezeiten bei 23°C

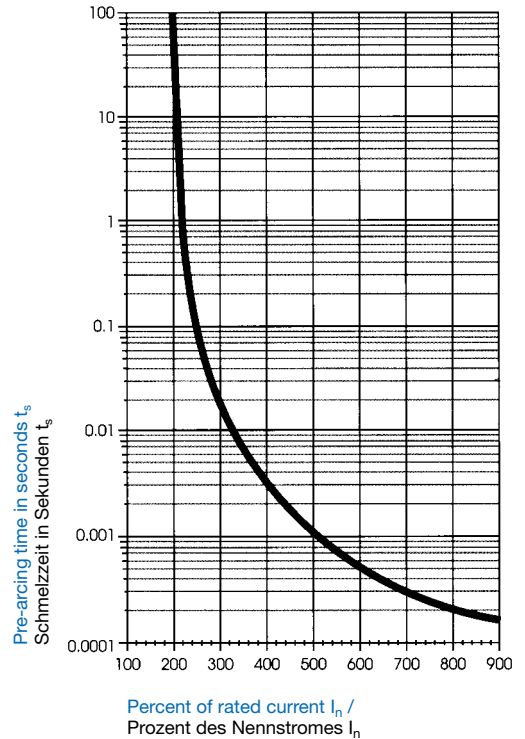

## FUSES / SICHERUNGEN

## NON RESETTABLE / NICHT RÜCKSTELLEND

Order No. / Bestell-Nr.	Rated current $I_n$ / Rated voltage $U_n$ / Nennstrom $I_n$ / Nennspannung $U_n$ mA / A / V ~	Breaking capacity / Ausschaltvermögen at / bei $I_n$ A ~ AC / DC	Voltage drop / Spannungsfall at / bei $I_n$ typ. mV	Resistance / Widerstand at / bei $\leq 10\% I_n$ Ohms / Ohm	Pre-arcing $I^2t$ / Schmelz $I^2t$ at / bei $4 \cdot I_n$ typ. A <sup>2</sup> s	Packaging Order No. Suffix / Verpackung
3410.0021.XX	200 mA / 125 V	50 A AC/ 300 A DC	212	0,87	0,0013	100 pieces taped & bagged: 100 Stück gegurtet .XX = .01
3410.0022.XX	250 mA / 125 V		176	0,63	0,0027	
3410.0025.XX	375 mA / 125 V		140	0,32	0,0039	750 pieces taped & reeled: 750 Stück Gegurtet auf Rollen .XX = .02
3410.0027.XX	500 mA / 125 V		126	0,20	0,0066	
3410.0029.XX	750 mA / 125 V		118	0,12	0,015	3000 pieces taped & reeled: 3000 Stück Gegurtet auf Rollen .XX = .03
3410.0031.XX	1 A / 125 V		135	0,10	0,042	
3410.0033.XX	1,5 A / 125 V		123	0,06	0,12	12000 pieces taped & reeled: 12000 Stück Gegurtet auf Rollen .XX = .04
3410.0035.XX	2 A / 125 V		117	0,04	0,20	
3410.0036.XX	2,5 A / 125 V		115	0,03	0,35	
3410.0037.XX	3 A / 125 V		112	0,02	0,55	
3410.0140.XX	4 A / 32 V		110	0,02	0,85	
3410.0141.XX	5 A / 32 V		108	0,01	1,0	

All ratings measured at 125 V, ambient temperature 25 °C +/-3 °C / Alle Werte gemessen bei 125 V, Umgebungstemperatur 25 °C ± 3 °C

AC with unity power factor. DC with time constant less than 1 msec. / AC mit Einheits cos  $\phi$ . DC mit einer Zeitkonstanten < 1 msec.

Order No. Telecom (MGA 125 V) Meets UL 1459 test requirem. Bestell-Nr.	Rated current $I_n$ / Rated voltage $U_n$ / Nennstrom $I_n$ / Nennspannung $U_n$ mA / A / V ~	Breaking capacity / Ausschaltvermögen at / bei $I_n$ A ~ AC / DC	Voltage drop / Spannungsfall at / bei $1,25 \cdot I_n$ typ. mV	Resistance / Widerstand at / bei $\leq 10\% I_n$ Ohms / Ohm	Pre-arcing $I^2t$ / Schmelz $I^2t$ at / bei $4 \cdot I_n$ typ. A <sup>2</sup> s	Packaging Order No. Suffix / Verpackung
3410.0022.XX	250 mA / 125 V	50 A AC / 300 A DC	176	0,632	0.0027	same as above / wie oben

All ratings measured at 125 V, ambient temperature 25 °C +/-3 °C / Alle Werte gemessen bei 125 V, Umgebungstemperatur 25 °C ± 3 °C

Sub-miniature fuse-links for surface mounting SUPRAFUSE CLASSIC

Type SFC 125 V quick-acting F

directly solderable on printed circuit boards with or without clips

Kleinst-Sicherungseinsätze für Oberflächenmontage SUPRAFUSE CLASSIC

Typ SFC 125 V flink F

direkt einlötlbar auf Leiterplatten mit oder ohne Haltefedern

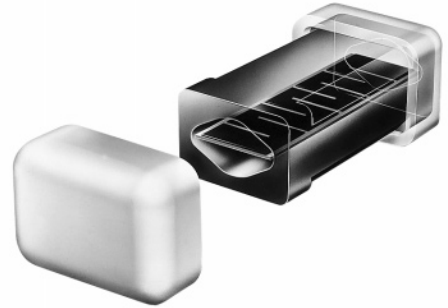

1:1

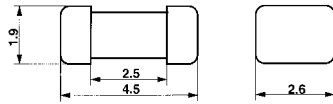

SUPRAFUSE with clips / mit Haltefedern fuse-link removable / Sicherungseinsatz auswechselbar

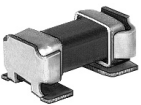

1:1

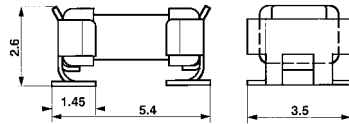

Solder pads for wave- and reflow soldering / Anschlussflächen für Wellen- und Reflow-Lötung

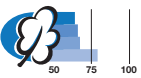
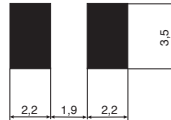

Standards / Normen

IEC 60127-4/2, EN 60127-4/2  
 UL 248-14 (formerly / früher 198.G)  
 CSA C22.2 No. 248.14 (formerly / früher 59.2 M) } with modifications based on IEC.../EN... / mit Modifikationen basierend auf IEC.../EN...

Approvals, Patents / Approbationen, Patente

UL CSA VDE only for version without clip / nur für Variante ohne Haltefeder

Patents in U.S and in further countries pending / Patente in US und weiteren Ländern angemeldet

Pre-arcing time/current characteristic (at T<sub>a</sub> 23 °C)

Zeit-Strom-Charakteristik (bei T<sub>u</sub> 23 °C)

n · I <sub>n</sub> Rated current I <sub>n</sub> / Nennstrom I <sub>n</sub>	1,25 · I <sub>n</sub>		2 · I <sub>n</sub>		10 · I <sub>n</sub>	
	min.	max.	min.	max.	min.	max.
0,8 – 4 A	1 h	120 s	1 ms	10 ms		

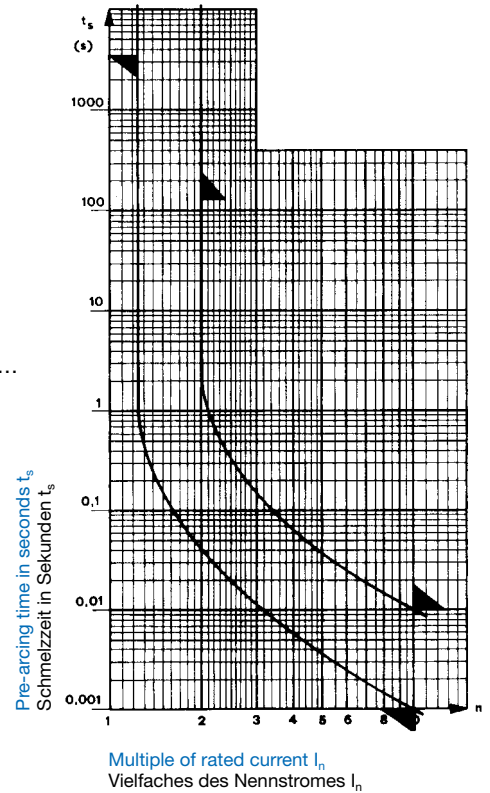

Order No. / Bestell-Nr.	Rated current I <sub>n</sub> / Rated voltage U <sub>n</sub> / Nennstrom I <sub>n</sub> / Nennspannung U <sub>n</sub>	Breaking capacity / Ausschaltvermögen	Voltage drop / Spannungsfall at / bei I <sub>n</sub> max.		Sustained power dissipation / Verlustleistung at / bei 1,25 · I <sub>n</sub> max.		Pre-arcing I <sup>2</sup> t / Schmelz I <sup>2</sup> t at / bei 10 · I <sub>n</sub>	Approvals / Approbationen wave and reflow soldering		
			IEC 60127 mV	typ. IEC mV	IEC 60127 mW	typ. IEC mW		UL	CSA	VDE
3405.0917.XX	0,8 A / 125 V	50 A / 125 V AC/DC p.f. / cos w 1	400	150	500	240	1,6 · 10 <sup>-1</sup>	•	•	•
3405.0918.XX	1 A / 125 V		300	140	500	280	2,0 · 10 <sup>-1</sup>	•	•	•
3405.0919.XX	1,25 A / 125 V		300	130	1000	330	4,0 · 10 <sup>-1</sup>	•	•	•
3405.0920.XX	1,6 A / 125 V		300	120	1000	400	6 · 10 <sup>-1</sup>	•	•	•
3405.0921.XX	2 A / 125 V		300	110	1000	480	8 · 10 <sup>-1</sup>	•	•	•
3405.0922.XX	2,5 A / 125 V		300	100	1000	500	1,9	•	•	•
3405.0923.XX	3,15 A / 125 V		300	90	1200	500	2,7	•	•	•
3405.0924.XX	4 A / 125 V		300	80	1500	600	2,1	•	•	•

.XX Index for packaging and SUPRAFUSE without or with clip / Index für Verpackung und SUPRAFUSE ohne oder mit Haltefeder

Additional technical data and packaging see page 54 / Zusätzliche technische Daten und Verpackung siehe Seite 54

SUPRA FUSE CLASSIC is a trademark of SCHURTER, registered in CH, USA and further countries / ist ein Warenzeichen von SCHURTER, eingetragen in CH, USA und weiteren Ländern

**Sub-miniature fuse-links for surface mounting SUPRAFUSE CHIPGUARD**

**Type SFP 63 V super-quick-acting FF**

directly solderable on printed circuit boards with or without clips

**Kleinst-Sicherungseinsätze für Oberflächenmontage SUPRAFUSE CHIPGUARD**

**Typ SFP 63 V superflink FF**

direkt einlötlbar auf Leiterplatten mit oder ohne Haltefedern

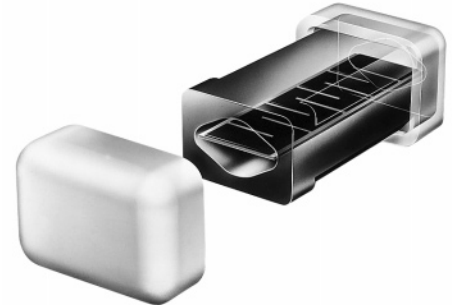

1:1

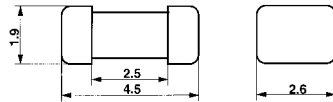

SUPRAFUSE with clips / mit Haltefedern  
fuse-link removable / Sicherungseinsatz auswechselbar



1:1

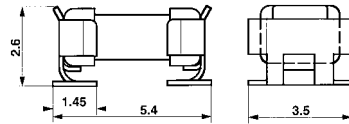

Solder pads for wave- and reflow soldering /  
Anschlussflächen für Wellen- und Reflow-Lötung

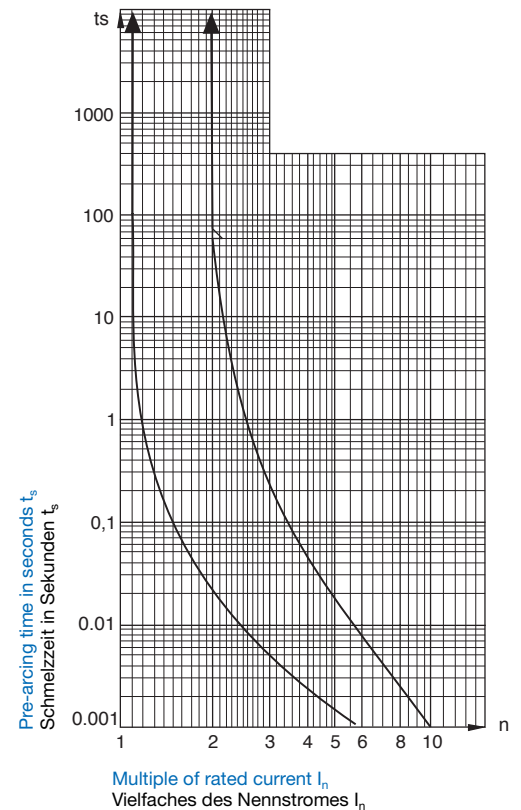
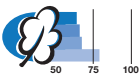

### Standards / Normen

UL 248-14 (formerly / früher 198.G)  
CSA C22.2 No. 248.14 (formerly / früher 59.2 M)

### Approvals, Patents / Approbationen, Patente

UL CSA

Patents in U.S and in further countries pending /  
Patente in US und weiteren Ländern angemeldet

### Pre-arcing time/current characteristic (at $T_a$ 23 °C)

### Zeit-Strom-Charakteristik (bei $T_u$ 23 °C)

$n \cdot I_n$	$1 \cdot I_n$	$2 \cdot I_n$
Rated current $I_n$ / Nennstrom $I_n$	min.	max.
1 – 5 A	4 h	60 s

Order No. / Bestell-Nr.	Rated current $I_n$ / Rated voltage $U_n$ / Nennstrom $I_n$ / Nennspannung $U_n$	Breaking capacity / Ausschaltvermögen	Voltage drop / Spannungsfall at / bei $I_n$		Sustained power dissipation / Verlustleistung at / bei $I_n$		Pre-arcing $I^2t$ / Schmelz $I^2t$ at / bei $10 \cdot I_n$		Approvals / Approbationen wave and reflow soldering	
			typ. mV	typ. mW	typ. $A^2s$					
3405.2207.XX	1 A / 63 V	50 A / 63 V AC/DC p.f. / cos $\phi$ 1	120	120	$1 \cdot 10^{-1}$	• •				
3405.2208.XX	1,25 A / 63 V		120	150	$1,8 \cdot 10^{-1}$	• •				
3405.2209.XX	1,5 A / 63 V		120	180	$2,5 \cdot 10^{-1}$	• •				
3405.2210.XX	2 A / 63 V		90	180	$5 \cdot 10^{-1}$	• •				
3405.2211.XX	2,5 A / 63 V		80	200	$6 \cdot 10^{-1}$	• •				
3405.2212.XX	3 A / 63 V		80	240	$9 \cdot 10^{-1}$	• •				
3405.2213.XX	3,5 A / 63 V		75	260	1,2	• •				
3405.2214.XX	4 A / 63 V		70	280	1,6	• •				
3405.2215.XX	5 A / 63 V		65	330	2,5	• •				

.XX Index for packaging and SUPRAFUSE without or with clip / Index für Verpackung und SUPRAFUSE ohne oder mit Haltefeder  
Additional technical data and packaging see page 54 / Zusätzliche technische Daten und Verpackung siehe Seite 54

is a trademark of SCHURTER, registered in CH, USA and further countries /  
ist ein Warenzeichen von SCHURTER, eingetragen in CH, USA und weiteren Ländern

**Technical data and packaging**

**SUPRAFUSE CLASSIC\***  
Type SFC 125 V

**SUPRAFUSE CHIPGUARD\***  
Type SFP 63 V

**Technische Daten und Verpackung**

**SUPRAFUSE CLASSIC\***  
Typ SFC 125 V

**SUPRAFUSE CHIPGUARD\***  
Typ SFP 63 V

\* without and with clips /  
ohne und mit Haltefedern



**Additional technical data / Zusätzliche technische Daten**

Technical data subject to change / Wir behalten uns vor, technische Angaben anzupassen

Ambient temperature max. $T_a$ / Zulässige Umgebungstemperatur $T_u$	- 40 °C to / bis +85 °C
Permissible continuous operating current at 23 °C / Zulässiger Dauerstrom bei 23 °C	SFC 125 V: $0,8 \times I_n$ Shift of the rated current at ambient air temperatures > 23 °C SFP 63 V: $0,7 \times I_n$ see diagram on page 44 Verschiebung des Nennstromes bei Umgebungstemperaturen > 23 °C siehe Diagramm Seite 44
Storage temperature max. / Max. Lagertemperatur	40 °C / 70% r. H. / r. F
Resistance to vibration /  Vibrationsbeständigkeit	Frequency 10 ÷ 2000 Hz, cross-over frequency 60 Hz < 60 Hz constant amplitude of 0,75 mm > 60 Hz constant acceleration of 100 m/s <sup>2</sup> (10 g) according to IEC 60068-2-6, Test Fc Frequenzbereich 10 ÷ 2000 Hz, Übergangsfrequenz 60 Hz < 60 Hz konstante Amplitude von 0,75 mm > 60 Hz konstante Beschleunigung von 100 m/s <sup>2</sup> (10 g) nach IEC 60068-2-6, Test Fc
Resistance to shock / Schockbeständigkeit	981 m/s <sup>2</sup> (100 g), 6 ms according to / nach IEC 60068-2-27 test Ea
Climatic category / Klimakategorie	GPF according to / nach DIN 40040
Soldering methods for / Lötmethoden für	Suprafuses
	Suprafuses with clips / Suprafuses mit Haltefedern
Materials /  Werkstoff /	Housing Terminals: fuse-link clip / Gehäuse Anschlüsse: Si-Einsatz Haltefeder
	Temperature resistant plastic, flammability class UL 94V-0 Copper-alloy, gold plated (approx. 0,1-0,2 mm) Copper-alloy, silver plated / Temperaturbeständiger Kunststoff, Brennbarkeitsstufe UL 94V-0 Kupferlegierung, vergoldet (ca. 0,1-0,2 mm) Kupferlegierung, versilbert
Net weight % / Nettogewicht %	SFC/SFP without clip / ohne Haltefeder: 5 g with clip / mit Haltefeder: 6,5 g

**Packaging /  
Verpackung**

**3405.XXXX.XX**

- 1 = SFC/SFP without clip, taped and reeled /  
ohne Haltefeder, Blistergurt auf Rolle
- 2 = SFC/SFP with clip, taped and reeled /  
mit Haltefeder, Blistergurt auf Rolle

Standard availabilities / Standardmengen:

- without clip / ohne Haltefeder
- 1 = 2000 pieces / Stück
- 2 = 8000 pieces / Stück
- with clip / mit Haltefeder
- 5 = 750 pieces / Stück
- 6 = 3000 pieces / Stück

**Blister tape and reel / Blistergurt und Rolle**

according to IEC 60286-3 / gemäss IEC 60286-3

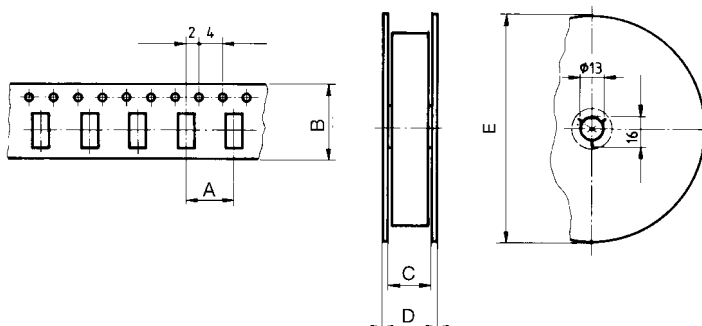

SUPRAFUSE types / Typen	Dimensions / Masse in mm				
	A	B	C	D	E
without clips / ohne Haltefedern	4	12	12	18,4	(750) (2000) (3000) (8000)
with clips / mit Haltefedern	8	12	12	18,4	180 330



**Sub-miniature fuse-links for surface mounting**  
**Type OMF 63**  
**quick-acting F**

directly solderable on printed circuit boards or plugable into surface mount fuseholder

**Kleinst-Sicherungseinsätze für Oberflächenmontage**  
**Typ OMF 63**  
**flink F**

direkt einlötlbar in Leiterplatten oder steckbar in oberflächenmontierbare Sicherungshalter

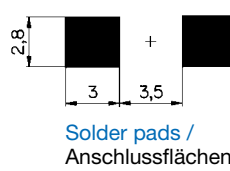
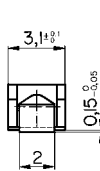
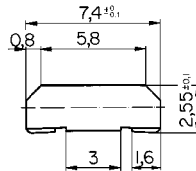
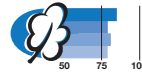

Solder pads / Anschlussflächen

**Standards / Normen**

UL 248-14 (formerly / früher 198.G)  
 CSA C22.2 No. 248.14 (formerly / früher 59.2 M)

**Pre-arcing time/current characteristic (at T<sub>a</sub> 23 °C)**

**Zeit-Strom-Charakteristik (bei T<sub>y</sub> 23 °C)**

n · I <sub>n</sub>	n · I <sub>n</sub>		
	1 · I <sub>n</sub> *	2 · I <sub>n</sub>	4 · I <sub>n</sub>
Rated current I <sub>n</sub> / Nennstrom I <sub>n</sub>	min.	max.	max.
63 mA – 5 A	4 h	1 s	10 ms
6,3 – 8 A	4 h	5 s	50 ms
10 A	4 h	20 s	60 ms

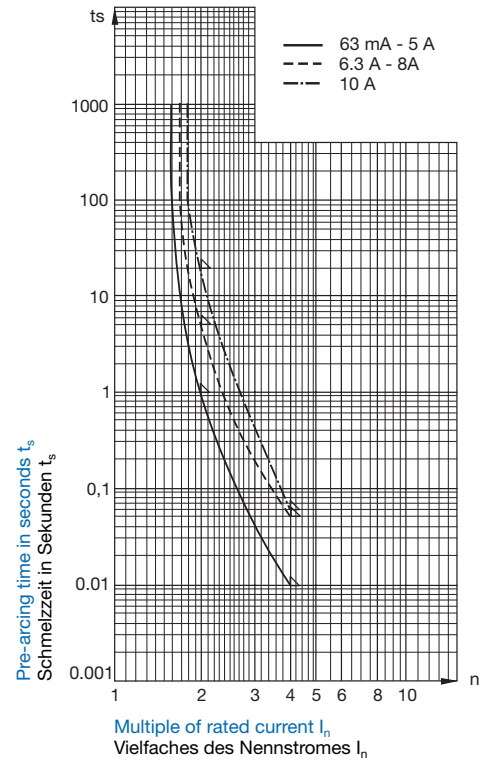

**Approvals, Patents / Approbationen, Patente**

UL CSA

Patents in U.S. (No. 4,851,806) and in further countries / Patente in US (Nr. 4,851,806) und in weiteren Ländern

\* Non fusing current I<sub>nf</sub> / Kleiner Prüfstrom I<sub>nf</sub>

Order No. / Bestell-Nr.	Rated current I <sub>n</sub> / Rated voltage U <sub>n</sub> / Nennstrom I <sub>n</sub> / Nennspannung U <sub>n</sub>	Breaking capacity / Ausschaltvermögen	Voltage drop / Spannungsfall at / bei I <sub>n</sub>	Sustained power dissipation / Verlustleistung at / bei 1 · I <sub>n</sub>	Pre-arcing I <sup>2</sup> t / Schmelz I <sup>2</sup> t at / bei 4 · I <sub>n</sub>	Approvals / Approbationen wave and reflow soldering
			typ. mV	typ. mW	typ. A <sup>2</sup> s	UL CSA
3402.0003.XX	63 mA / 63 V	50 A / 63 V AC/DC p.f. / cos w 1	2550	160	1,1 · 10 <sup>-4</sup>	• •
3402.0004.XX	100 mA / 63 V		1770	180	6,7 · 10 <sup>-3</sup>	• •
3402.0049.XX	125 mA / 63 V		1770	220	1,1 · 10 <sup>-3</sup>	• •
3402.0005.XX	160 mA / 63 V		1700	270	1,8 · 10 <sup>-3</sup>	• •
3402.0006.XX	250 mA / 63 V		990	250	5,8 · 10 <sup>-3</sup>	• •
3402.0043.XX	350 mA / 63 V		430	150	8,4 · 10 <sup>-3</sup>	• •
3402.0044.XX	375 mA / 63 V		410	150	1,1 · 10 <sup>-2</sup>	• •
3402.0007.XX	400 mA / 63 V		360	140	9,6 · 10 <sup>-3</sup>	• •
3402.0045.XX	500 mA / 63 V		350	180	1,6 · 10 <sup>-2</sup>	• •
3402.0008.XX	630 mA / 63 V		350	220	2,3 · 10 <sup>-2</sup>	• •
3402.0046.XX	750 mA / 63 V		300	230	5,2 · 10 <sup>-2</sup>	• •
3402.0009.XX	1 A / 63 V		220	220	8,6 · 10 <sup>-2</sup>	• •
3402.0010.XX	1,25 A / 63 V		220	280	1,4 · 10 <sup>-1</sup>	• •
3402.0047.XX	1,5 A / 63 V		200	320	2,4 · 10 <sup>-1</sup>	• •
3402.0011.XX	1,6 A / 63 V		200	300	2,7 · 10 <sup>-1</sup>	• •
3402.0012.XX	2 A / 63 V		200	400	4,4 · 10 <sup>-1</sup>	• •
3402.0013.XX	2,5 A / 63 V		190	480	7,9 · 10 <sup>-1</sup>	• •
3402.0014.XX	3 A / 63 V		190	570	1,1	• •
3402.0048.XX	3,15 A / 63 V		190	600	1,1	• •
3402.0015.XX	3,5 A / 63 V		140	490	1,6	• •
3402.0016.XX	4 A / 63 V		140	560	2,1	• •
3402.0017.XX	5 A / 63 V		140	700	2,9	• •
3402.0018.XX	6,3 A / 63 V		110	690	14	• •
3402.0019.XX	7 A / 63 V		105	740	16	• •
3402.0020.XX	8 A / 63 V		100	800	20	• •
3402.0040.XX	10 A / 63 V		80	800	54	• •

.XX Packaging index / Verpackungsindex

Additional technical data and packaging see page 59 / Zusätzliche technische Daten und Verpackung siehe Seite 59



Suitable surface mount fuseholder see page 193 / Passender oberflächenmontierbarer Sicherungshalter siehe Seite 193



OMF 63 fuse-link pre-inserted into fuseholder OMH 125 see page 60 / OMF 63 Si-Einsatz eingesetzt in Sicherungshalter OMH 125 siehe Seite 60

**Sub-miniature fuse-links for surface mounting Type OMF 125 quick-acting F**

directly solderable on printed circuit boards or plugable into surface mount fuseholder

**Kleinst-Sicherungseinsätze für Oberflächenmontage Typ OMF 125**

flink F

direkt einlötlbar auf Leiterplatten oder steckbar in oberflächenmontierbare Sicherungshalter

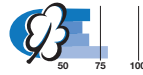

1:1

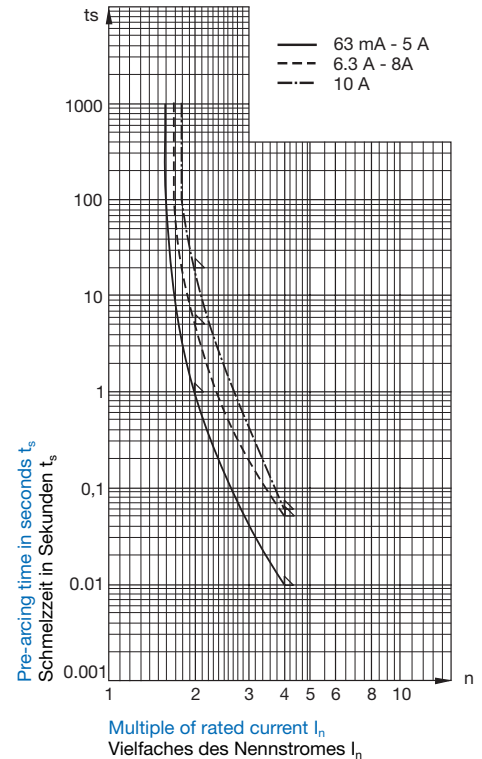
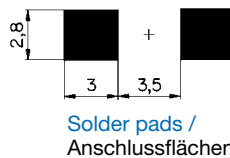
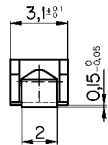
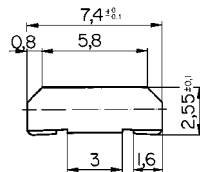

**Standards / Normen**

UL 248-14 (formerly / früher 198.G)  
CSA C22.2 No. 248.14 (formerly / früher 59.2 M)

**Pre-arcing time/current characteristic (at T<sub>a</sub> 23 °C)**

**Zeit-Strom-Charakteristik (bei T<sub>u</sub> 23 °C)**

n · I <sub>n</sub>	n · I <sub>n</sub>		
	1 · I <sub>n</sub> *	2 · I <sub>n</sub>	4 · I <sub>n</sub>
Rated current I <sub>n</sub> / Nennstrom I <sub>n</sub>	min.	max.	max.
63 mA – 5 A	4 h	1 s	10 ms
6,3 – 8 A	4 h	5 s	50 ms
10 A	4 h	20 s	60 ms

**Approvals, Patents / Approbationen, Patente**



Patents in U.S. (No. 4,851,806) and in further countries / Patente in US (Nr. 4,851,806) und in weiteren Ländern

\* Non fusing current I<sub>nf</sub> / Kleiner Prüfstrom I<sub>nf</sub>

Order No. / Bestell-Nr.	Rated current I <sub>n</sub> / Rated voltage U <sub>n</sub> / Nennstrom I <sub>n</sub> / Nennspannung U <sub>n</sub>	Breaking capacity / Ausschaltvermögen	Voltage drop / Spannungsfall at / bei I <sub>n</sub>	Sustained power dissipation / Verlustleistung at / bei 1 · I <sub>n</sub>	Pre-arcing I <sup>2</sup> t / Schmelz I <sup>2</sup> t at / bei 4 · I <sub>n</sub>	Approvals / Approbationen wave and reflow soldering	
3404.0003.XX	63 mA / 125 V	300 A / 125 V AC p.f. / cos w 1	2550	160	1,1 · 10 <sup>-4</sup>	UL CSA	
3404.0004.XX	100 mA / 125 V		1770	180	6,7 · 10 <sup>-3</sup>		
3404.0049.XX	125 mA / 125 V		1770	220	1,1 · 10 <sup>-3</sup>		
3404.0005.XX	160 mA / 125 V		1700	270	1,8 · 10 <sup>-3</sup>		
3404.0006.XX	250 mA / 125 V		990	250	5,8 · 10 <sup>-3</sup>		
3404.0043.XX	350 mA / 125 V		430	150	8,4 · 10 <sup>-3</sup>		
3404.0044.XX	375 mA / 125 V		410	150	1,1 · 10 <sup>-3</sup>		
3404.0007.XX	400 mA / 125 V		360	140	9,6 · 10 <sup>-3</sup>		
3404.0045.XX	500 mA / 125 V		350	180	1,6 · 10 <sup>-2</sup>		
3404.0008.XX	630 mA / 125 V		350	220	2,3 · 10 <sup>-2</sup>		
3404.0046.XX	750 mA / 125 V		300	230	5,2 · 10 <sup>-2</sup>		
3404.0009.XX	1 A / 125 V		220	220	8,6 · 10 <sup>-2</sup>		
3404.0010.XX	1,25 A / 125 V		220	280	1,4 · 10 <sup>-1</sup>		
3404.0047.XX	1,5 A / 125 V		400 A / 125 V DC	200	320		2,4 · 10 <sup>-1</sup>
3404.0011.XX	1,6 A / 125 V		200	300	2,7 · 10 <sup>-1</sup>		
3404.0012.XX	2 A / 125 V		200	400	4,4 · 10 <sup>-1</sup>		
3404.0013.XX	2,5 A / 125 V		190	480	7,9 · 10 <sup>-1</sup>		
3404.0014.XX	3 A / 125 V		190	570	1,1		
3404.0048.XX	3,15 A / 125 V		190	600	1,1		
3404.0015.XX	3,5 A / 125 V		140	490	1,6		
3404.0016.XX	4 A / 125 V	140	560	2,1			
3404.0017.XX	5 A / 125 V	140	700	2,9			
3404.0018.XX	6,3 A / 125 V	200 A / 125 V AC p.f. / cos w 1	110	690	14		
3404.0019.XX	7 A / 125 V	300 A / 125 V DC	105	740	16		
3404.0020.XX	8 A / 125 V	100 A / 125 V AC p.f. / cos w 1	100	800	20		
3404.0021.XX	10 A / 125 V	300 A / 125 V DC	80	800	54		

.XX Packaging index / Verpackungsindex

Additional technical data and packaging see page 59 / Zusätzliche technische Daten und Verpackung siehe Seite 59



Suitable surface mount fuseholder see page 193 / Passender oberflächenmontierbarer Sicherungshalter siehe Seite 193



OMF 125 fuse-link pre-inserted into fuseholder OMH 125 see page 60 / OMF 125 Si-Einsatz eingesetzt in Sicherungshalter OMH 125 siehe Seite 60

# FUSES / SICHERUNGEN

# NON RESETTABLE / NICHT RÜCKSTELLEND

**Sub-miniature fuse-links for surface mounting Type OMF 250 quick-acting F**

directly solderable on printed circuit boards

**Kleinst-Sicherungseinsätze für Oberflächenmontage Typ OMF 250**

**flink F**

direkt einlötlbar auf Leiterplatten



1:1

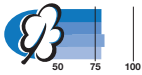
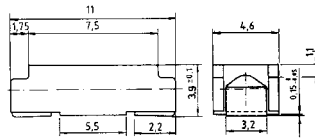

Solder pads / Anschlussflächen

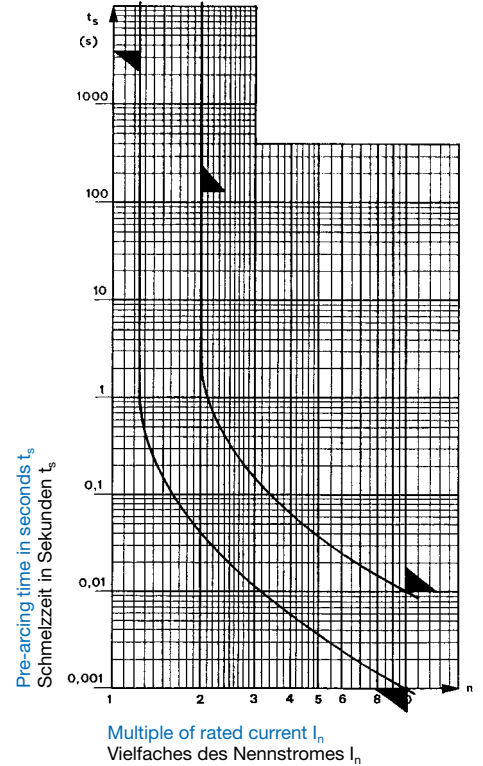

### Standards / Normen

IEC 60127-4/2; EN 60127-4/2  
 UL 248-14 (formerly / früher 198.G)  
 CSA C22.2 No. 248.14 (formerly / früher 59.2 M) } with modifications based on IEC.../EN... /  
 } mit Modifikationen basierend auf IEC.../EN...

### Pre-arcing time/current characteristic (at $T_a$ 23 °C)

### Zeit-Strom-Charakteristik (bei $T_U$ 23 °C)

Rated current $I_n$ / Nennstrom $I_n$	$n \cdot I_n$		$2 \cdot I_n$		$10 \cdot I_n$	
	min.	IEC/UL max.	CSA max.	min.	max.	
250 mA – 4 A	1 h	120 s	60 s	1 ms	10 ms	

\* Non fusing current  $I_{nf}$  / Kleiner Prüfstrom  $I_{nf}$

### Approvals, Patents / Approbationen, Patente



Patents in U.S. (No. 4,851,806) and in further countries /  
 Patente in US (Nr. 4,851,806) und in weiteren Ländern

Order No. / Bestell-Nr.	Rated current $I_n$ / Rated voltage $U_n$ / Nennstrom $I_n$ / Nennspannung $U_n$	Breaking capacity / Ausschaltvermögen	Voltage drop / Spannungsfall at / bei $I_n$ max.		Sustained power dissipation / Verlustleistung at / bei $1,25 I_n$ max.		Pre-arcing $I^2t$ / Schmelz $I^2t$ at / bei $10 \cdot I_n$ typ. $A^2s$	Approvals / Approbationen					
			IEC 60127 mV	typ. mV	IEC 60127 mW	typ. mW		UL	CSA	VDE	UL	CSA	VDE
3403.0010.XX	250 mA / 250 V	100 A / 250 V AC p.f. / cos $\phi$ 1  100 A / 250 V DC	800	435	500	110	$9 \cdot 10^{-3}$	•	•	•	•	•	•
3403.0011.XX	315 mA / 250 V		750	395	500	125	$1,7 \cdot 10^{-2}$	•	•	•	•	•	•
3403.0012.XX	400 mA / 250 V		700	230	500	190	$2 \cdot 10^{-2}$	•	•	•	•	•	•
3403.0013.XX	500 mA / 250 V		600	190	500	190	$4 \cdot 10^{-2}$	•	•	•	•	•	•
3403.0014.XX	630 mA / 250 V		500	170	500	230	$8 \cdot 10^{-2}$	•	•	•	•	•	•
3403.0015.XX	800 mA / 250 V		400	200	500	330	$1,3 \cdot 10^{-1}$	•	•	•	•	•	•
3403.0016.XX	1 A / 250 V		300	170	500	390	$2,3 \cdot 10^{-1}$	•	•	•	•	•	•
3403.0017.XX	1,25 A / 250 V		300	150	1000	390	$4,7 \cdot 10^{-1}$	•	•	•	•	•	•
3403.0018.XX	1,6 A / 250 V		300	150	1000	490	$8,4 \cdot 10^{-1}$	•	•	•	•	•	•
3403.0019.XX	2 A / 250 V		300	140	1000	600	1,4	•	•	•	•	•	•
3403.0020.XX	2,5 A / 250 V		300	130	1000	670	2,6	•	•	•	•	•	•
3403.0021.XX	3,15 A / 250 V		300	130	1200	870	4,3	•	•	•	•	•	•
3403.0022.XX	4 A / 250 V		300	100	1500	950	8,6	•	•	•	•	•	•

.XX Packaging index / Verpackungsindex

Additional technical data and packaging see page 59 / Zusätzliche technische Daten und Verpackung siehe Seite 59

**Sub-miniature fuse-links for surface mounting Type OMT 250 time-lag T**

directly solderable on printed circuit boards

**NEW**

**Kleinst-Sicherungseinsätze für Oberflächenmontage Typ OMT 250**

träge T

direkt einlötlbar auf Leiterplatten

**NEW**



1:1

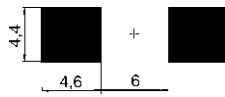
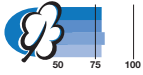
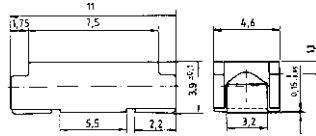

Solder pads / Anschlussflächen

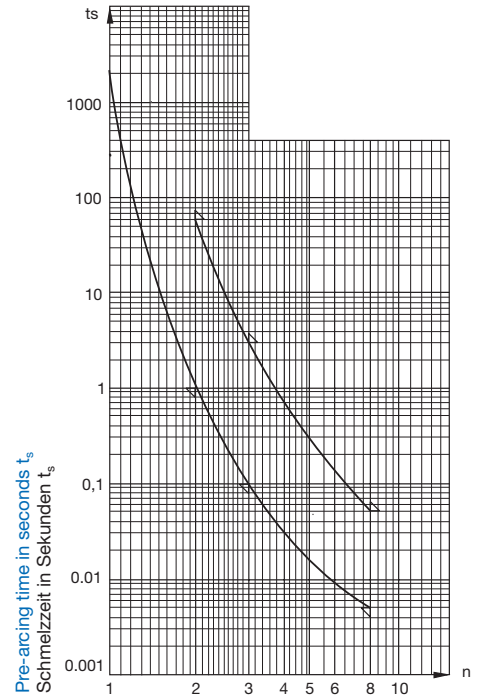

Multiple of rated current  $I_n$   
Vielfaches des Nennstromes  $I_n$

**Standards / Normen**

UL 248-14 (formerly / früher 198.G)  
CSA C22.2 No. 248.14 (formerly / früher 59.2 M)

**Pre-arcing time/current characteristic (at  $T_a$  23 °C)**

**Zeit-Strom-Charakteristik (bei  $T_u$  23 °C)**

Rated current $I_n$ / Nennstrom $I_n$	$1.0 \cdot I_n$ UL		$2 \cdot I_n$ UL		$3 \cdot I_n$		$8 \cdot I_n$	
	min.	max.	min.	max.	min.	max.	min.	max.
0,75 – 5 A	4 h	1 s	60 s	100 ms	3 s	5 ms	50 ms	

**Approvals, Patents / Approbationen, Patente**



Patents in U.S. (No. 4,851,806) and in further countries  
Patente in US (Nr. 4,851,806) und in weiteren Ländern

\* Non fusing current  $I_{nf}$  / Kleiner Prüfstrom  $I_{nf}$

Order No. / Bestell-Nr.	Rated current $I_n$ / Rated voltage $U_n$ / Nennstrom $I_n$ / Nennspannung $U_n$	Breaking capacity / Ausschaltvermögen	Voltage drop / Spannungsfall at / bei $I_n$	Sustained power dissipation / Verlustleistung at / bei $4 \cdot I_n$	Pre-arcing $I^2t$ / Schmelz $I^2t$ at / bei $8 \cdot I_n$	Approvals / Approbationen	
						UL	CSA
3403.0129.XX	750 mA / 250 V	100A/250V AC p.f./cos w 1	107	80	$3 \cdot 10^{-1}$	✓	✓
3403.0116.XX	1 A / 250 V		90	90	$7 \cdot 10^{-1}$	✓	✓
3403.0117.XX	1,25 A / 250 V		89	111	1,0	✓	✓
3403.0130.XX	1,5 A / 250 V		74	111	2,0	✓	✓
3403.0119.XX	2 A / 250 V		69	138	4,0	✓	✓
3403.0120.XX	2,5 A / 125 V		68	170	7,0	✓	✓
3403.0131.XX	3 A / 125 V		62	186	12,0	✓	✓
3403.0132.XX	3,5 A / 125 V		60	210	19,0	✓	✓
3403.0122.XX	4 A / 125 V		60	240	23,0	✓	✓
3403.0123.XX	5 A / 125 V		57	285	37,0	✓	✓

.XX Packaging index / Verpackungsindex

Additional technical data and packaging see page 59 / Zusätzliche technische Daten und Verpackung siehe Seite 59

**Technical data and packaging**
**Types** OMF 63  
 OMF 125  
 OMF 250  
 OMT 250

**Technische Daten und Verpackung**
**Typen** OMF 63  
 OMF 125  
 OMF 250  
 OMT 250

**Additional technical data / Zusätzliche technische Daten**

Ambient temperature max. $T_a$ Zulässige Umgebungstemperatur $T_u$	- 40 °C to / bis + 85 °C
Permissible continuous operating current at 23 °C / Zulässiger Dauerstrom bei 23 °C	OMF 63: $0,7 \times I_n$ Shift of the rated current at ambient air temperatures > 23 °C OMF 125: $0,7 \times I_n$ see diagramm on page 44 OMF 250 } $0,8 \times I_n$ Verschiebung des Nennstromes bei Umgebungstemperaturen > 23 °C OMT 250 } siehe Diagramm Seite 44
Resistance to vibration / Vibrationsbeständigkeit	Frequency 10 ÷ 2000 Hz, cross-over frequency 60 Hz < 60 Hz constant Amplitude of 0,75 mm > 60 Hz constant acceleration of 100 m/s <sup>2</sup> (10 g); OMF 250, OMT 250: 196 m/s <sup>2</sup> (20 g) according to IEC 60068-2-6, Test Fc Frequenzbereich 10 ÷ 2000 Hz, Übergangsfrequenz 60 Hz < 60 Hz konstante Amplitude von 0,75 mm > 60 Hz konstante Beschleunigung von 100 m/s <sup>2</sup> (10 g); OMF 250, OMT 250: 196 m/s <sup>2</sup> (20 g) nach IEC 60068-2-6, Test Fc
Resistance to shock / Schockbeständigkeit	981 m/s <sup>2</sup> (100 g), 6 ms, IEC 60068-2-27 test Ea
Climatic category / Klimakategorie	GPF according to / nach DIN 40040
Solderability (Reflow- and Wave soldering) / Lötbarkeit (Reflow und Wellenlötung)	235 °C / 2 sec. IEC 60068-2-58 / test / Test Td
Soldering heat resistance / Lötwärmebeständigkeit	260 °C / 10 sec. IEC 60068-2-58 / test / Test Td
Fuse-link temperature rise $\leq 75$ K (UL/CSA) / Temperaturerhöhungen am Si-Einsatz $\leq 75$ K (UL/CSA)	trackwidth for: $I_n \leq 5$ A: $\leq 5$ mm Leiterbahnbreite für: $I_n$ 6,3/7A $\geq 5$ mm $I_n$ 8/10A $\geq 10$ mm
Storage temperature max. / max. Lagertemperatur	40 °C / 70% r. H / r. F.
Materials Housing Terminals / Werkstoffe Gehäuse Anschlüsse	Temperature resistant plastic, flammability class UL 94V-0 Brass, tin plated Temperaturbeständiger Kunststoff, Brennbarkeitsstufe UL 94V-0 Messing verzinkt
Net weight pieces % / Nettogewicht % Stück	OMF 63 and / und OMF 125: 10 g OMF 250 / OMT 250: 35 g

**Packaging / Verpackung**

Box or tape / Schachtel oder Gurt	Type / Typ OMF 63	Type / Typ OMF 125	Types / Typen OMF 250 / OMT 250
Boxes of 100 pieces / lose geschüttet à 100 Stück	3402.XXXX.11	3404.XXXX.11	3403.XXXX.11
Taped and reeled 750 pieces / Blistergurt à 750 Stück auf Rolle	3402.XXXX.22	3404.XXXX.22	
Taped and reeled 2000 pieces / Blistergurt à 2000 Stück auf Rolle			3403.XXXX.24
Taped and reeled 3000 pieces / Blistergurt à 3000 Stück auf Rolle	3402.XXXX.24	3404.XXXX.24	

**Blister tape and reel / Blistergurt und Rolle**

according to IEC 286-3 / gemäss IEC 286-3

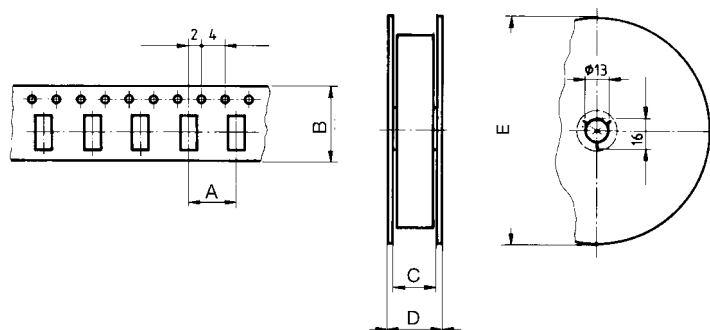

Types / Typen	Dimensions / Masse in mm						
	A	B	C (max.)	D (max.)	E (750)	(2000)	(3000)
OMF 63	8	16	18,4	22,4	180		330
OMF 125	8	16	18,4	22,4	180		330
OMF 250	8	24	26,4	30,4		330	
OMT 250							

## Sub-miniature fuses for surface mounting Types OMK 63/125

Fuseholder OMH with pre-inserted fuse-link OMF quick-acting F

directly solderable on printed circuit boards, reflow soldering





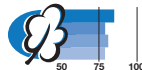

## Kleinst-Sicherungen für Oberflächenmontage Typen OMK 63/125

Sicherungshalter OMH mit eingesetztem Sicherungseinsatz OMF flink F

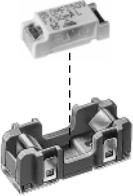
direkt einlötbar auf Leiterplatten, Reflow-Lötung

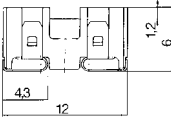
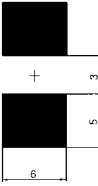
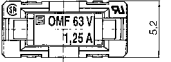
### Approvals / Approbationen

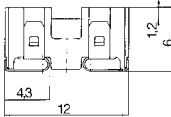

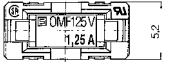
		Type / Typ OMK 63 (OMH 125 + OMF 63) Rated voltage $U_n$ 63 V Nennspannung $U_n$ 63 V		Type / Typ OMK 125 (OMH 125 + OMF 125) Rated voltage $U_n$ 125 V Nennspannung $U_n$ 125 V		
		   		   		
Rated current $I_n$ Nennstrom $I_n$	Order No. / Bestell-Nr.	Approvals / Approbationen		Order No. / Bestell-Nr.	Approvals / Approbationen	
		UL	CSA		UL	CSA
63 mA	3422.0003.XX	•	•	3404.2303.XX	•	•
100 mA	3422.0004.XX	•	•	3404.2304.XX	•	•
125 mA	3422.0049.XX	•	•	3404.2349.XX	•	•
160 mA	3422.0005.XX	•	•	3404.2305.XX	•	•
250 mA	3422.0006.XX	•	•	3404.2306.XX	•	•
350 mA	3422.0043.XX	•	•	3404.2343.XX	•	•
375 mA	3422.0044.XX	•	•	3404.2344.XX	•	•
400 mA	3422.0007.XX	•	•	3404.2307.XX	•	•
500 mA	3422.0045.XX	•	•	3404.2345.XX	•	•
630 mA	3422.0008.XX	•	•	3404.2308.XX	•	•
750 mA	3422.0046.XX	•	•	3404.2346.XX	•	•
800 mA						
1 A	3422.0009.XX	•	•	3404.2309.XX	•	•
1,25 A	3422.0010.XX	•	•	3404.2310.XX	•	•
1,5 A	3422.0047.XX	•	•	3404.2347.XX	•	•
1,6 A	3422.0011.XX	•	•	3404.2311.XX	•	•
2 A	3422.0012.XX	•	•	3404.2312.XX	•	•
2,5 A	3422.0013.XX	•	•	3404.2313.XX	•	•
3 A	3422.0014.XX	•	•	3404.2314.XX	•	•
3,15 A	3422.0048.XX	•	•	3404.2348.XX	•	•
3,5 A	3422.0015.XX	•	•	3404.2315.XX	•	•
4 A	3422.0016.XX			3404.2316.XX	•	•
5 A	3422.0017.XX			3404.2317.XX	•	•

.XX = Packaging index / Verpackungsindex

Additional technical data and packaging see page 61 / Zusätzliche technische Daten und Verpackung siehe Seite 61

## FUSES / SICHERUNGEN

## NON RESETTABLE / NICHT RÜCKSTELLEND

### Additional technical data / Zusätzliche technische Daten

Sub-miniature fuse-links / Kleinst-Sicherungseinsätze

OMF 63: [pages](#) / Seiten 55, 59

OMF 125: [pages](#) / Seiten 56, 59

Fuseholder / Sicherungshalter

OMH 125: [page](#) / Seite 193

Net weight % / Nettogewicht %

OMK 63: 47 g

OMK 125: 58 g

### Remark / Bemerkung

The fuse-link which is inserted in the OMK cannot be soldered directly on the printed circuit board /

Der im OMK eingesetzte Kleinstsicherungseinsatz kann nicht direkt auf Leiterplatten gelötet werden.

### Packaging / Verpackung

Box or tape / Schachtel oder Gurt	Type / Typ OMK 63	Type / Typ OMK 125
Boxes of 100 pieces / lose geschüttet à 100 Stück	3422.XXXX.11	3404.XXXX.11
Taped and reeled 750 pieces / Blistergurt à 750 Stück auf Rolle		3404.XXXX.22
Taped and reeled 1500 pieces / Blistergurt à 1500 Stück auf Rolle	3422.XXXX.23	3404.XXXX.23

### Blister tape and reel / Blistergurt und Rolle

according to IEC 60286-3 / gemäss IEC 60286-3

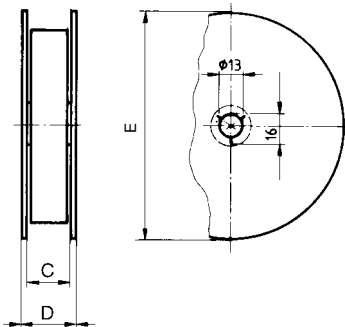
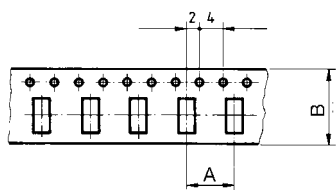

Types / Typen	Dimensions / Masse in mm					
	A	B	C (max.)	D (max.)	E (750)	(1500)
OMK 63	8	24	26,4	30,4		330
OMK 125	8	24	26,4	30,4	180	330

**Sub-miniature fuse-links for surface mounting Type 172876**  
 quick-acting F

directly solderable on printed circuit boards or plugable into surface mount fuseholder

**Kleinst-Sicherungseinsätze für Oberflächenmontage Typ 172876**  
 flink F

direkt einlötlbar auf Leiterplatten oder steckbar in oberflächenmontierbare Sicherungshalter

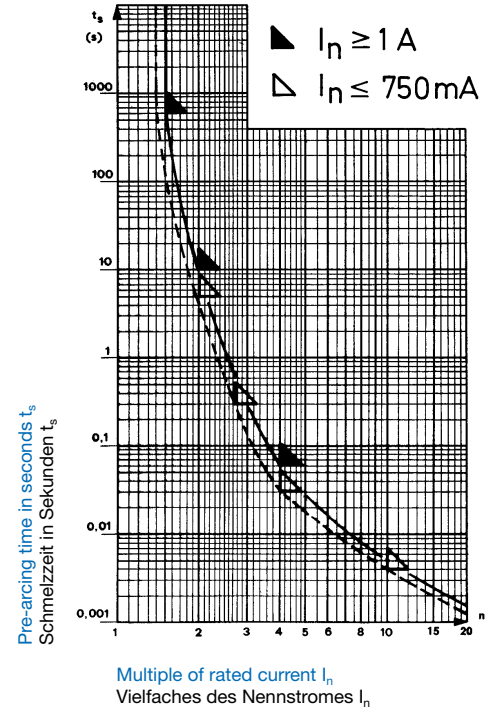
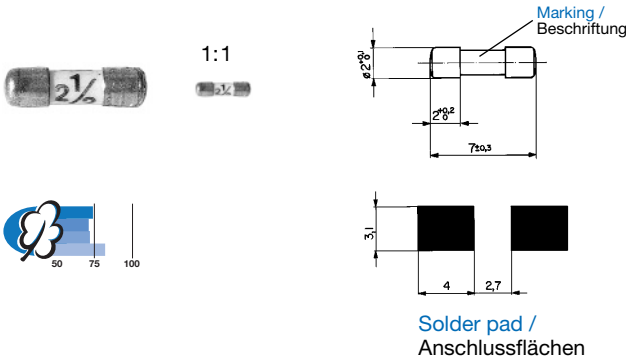

**Standards / Normen**

UL 248-14 (formerly / früher 198.G)  
 CSA C22.2 No. 248.14 (formerly / früher 59.2 M)

**Approvals / Approbationen**



**Pre-arcing time/current characteristic (at T<sub>a</sub> 23 °C)**

**Zeit-Strom-Charakteristik (bei T<sub>u</sub> 23 °C)**

Rated current I <sub>n</sub> / Nennstrom I <sub>n</sub>	n · I <sub>n</sub>					
	1 · I <sub>n</sub> *	1,5 · I <sub>n</sub>	2 · I <sub>n</sub>	2,75 · I <sub>n</sub>	4 · I <sub>n</sub>	10 · I <sub>n</sub>
	min.	max.	max.	max.	max.	max.
125 mA–750 mA	4 h		5 s	300 ms	30 ms	4 ms
1 A – 7 A	4 h	600 s	10 s		60 ms	

\* Non fusing current I<sub>nf</sub> / Kleiner Prüfstrom I<sub>nf</sub>

Order No. / Bestell-Nr.	Rated current I <sub>n</sub> / Rated voltage U <sub>n</sub> / Nennstrom I <sub>n</sub> / Nennspannung U <sub>n</sub>	Breaking capacity / Ausschaltvermögen	Voltage drop / Spannungsfall at / bei I <sub>n</sub> max.	Sustained power dissipation / Verlustleistung at / bei 1 · I <sub>n</sub> max.	Pre-arcing I <sup>2</sup> t / Schmelz I <sup>2</sup> t at / bei 10 · I <sub>n</sub>	Approvals / Approbationen
			mV	mW	A <sup>2</sup> s	UL CSA
7010.9760.XX	125 mA / 125 V	on printed boards: auf Leiterplatte: 300 A / 125 V AC cos w = 1 300 A / 125 V DC, L/R = 1 ms inserted into fuseholder: eingesetzt in Sicher.-halter: I <sub>n</sub> 125 mA – 4A: 300 A / 125 V AC cos w = 1 300 A / 125 V DC, L/R = 1 ms I <sub>n</sub> 5 – 7A: 300 A / 125 V AC cos w = 1 50 A / 125 V DC, L/R = 1 ms	810	105	3,6 · 10 <sup>-3</sup>	• •
7010.9770.XX	250 mA / 125 V		295	74	9,4 · 10 <sup>-3</sup>	• •
7010.9780.XX	375 mA / 125 V		225	85	1,9 · 10 <sup>-2</sup>	• •
7010.9790.XX	500 mA / 125 V		235	120	7 · 10 <sup>-2</sup>	• •
7010.9800.XX	750 mA / 125 V		225	170	1,8 · 10 <sup>-1</sup>	• •
7010.9810.XX	1 A / 125 V		190	190	3 · 10 <sup>-1</sup>	• •
7010.9820.XX	1,5 A / 125 V		210	315	3,8 · 10 <sup>-1</sup>	• •
7010.9830.XX	2 A / 125 V		175	350	1,1	• •
7010.9840.XX	2,5 A / 125 V		160	400	1,4	• •
7010.9850.XX	3 A / 125 V		155	465	2	• •
7010.9860.XX	3,5 A / 125 V	145	510	2,6	• •	
7010.9870.XX	4 A / 125 V	165	660	4	• •	
7010.9880.XX	5 A / 125 V	155	775	6,2	• •	
7010.9890.XX	7 A / 125 V	125	875	13	• •	

.XX Packaging index / Verpackungsindex

Additional technical data and packaging see page 66 / Zusätzliche technische Daten und Verpackung siehe Seite 66



FUSES / SICHERUNGEN

NON RESETTABLE / NICHT RÜCKSTELLEND

**Sub-miniature fuse-links for surface mounting Type MSB time-lag T**

directly solderable on printed circuit boards or plugable into surface mount fuseholder

**NEW**

**Kleinst-Sicherungseinsätze für Oberflächenmontage Typ MSB träge T**

direkt einlötlbar auf Leiterplatten oder steckbar in oberflächenmontierbare Sicherungshalter

**NEU**



1:1

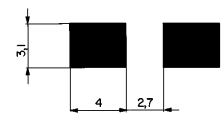
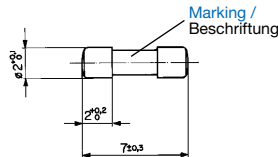
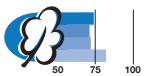

Solder pad / Anschlussflächen

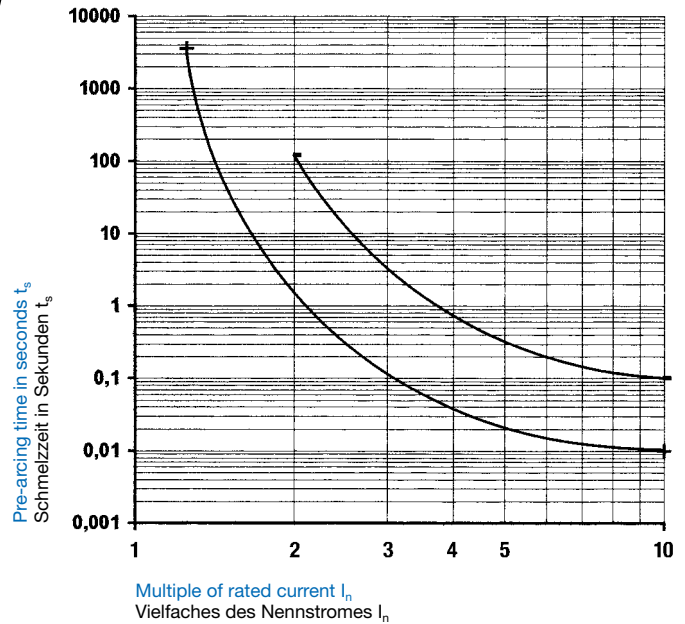

Standards / Normen

IEC 60127-4/2, EN 60127-4/2

Approvals / Approbationen

pending / angemeldet

Pre-arcing time/current characteristic (at T<sub>a</sub> 23 °C)

Zeit-Strom-Charakteristik (bei T<sub>u</sub> 23 °C)

Rated current I <sub>n</sub> / Nennstrom I <sub>n</sub>	1,25 · I <sub>n</sub> *		2 · I <sub>n</sub>		10 · I <sub>n</sub>	
	min.	max.	min.	max.	min.	max.
2-6,3 A	1 h	120 s	10 ms	100 ms		

\* Non fusing current I<sub>nf</sub> / Kleiner Prüfstrom I<sub>nf</sub>

Order No. / Bestell-Nr.	Rated current I <sub>n</sub> / Rated voltage U <sub>n</sub> / Nennstrom I <sub>n</sub> / Nennspannung U <sub>n</sub>	Breaking capacity / Ausschaltvermögen	Voltage drop / Spannungsfall at / bei I <sub>n</sub> max.	Sustained power dissipation / Verlustleistung at / bei 1 · I <sub>n</sub> max.	Pre-arcing I <sup>2</sup> t / Schmelz I <sup>2</sup> t at / bei 10 · I <sub>n</sub>	Approvals / Approbationen
7010.9963.XX	2 A / 125 V	50 A / 125 V AC/DC	90	on request / auf Anfrage	5,1	pending / angemeldet
7010.9964.XX	2,5 A / 125 V		90		8,7	
7010.9965.XX	3,15 A / 125 V		85		15	
7010.9966.XX	3,5 A / 125 V		85		19	
7010.9967.XX	4 A / 125 V		80		27	
7010.9968.XX	5 A / 125 V		105		30	
7010.9969.XX	6,3 A / 125 V	63 A / 125 V AC/DC	85		81	

.XX Packaging index / Verpackungsindex

Additional technical data and packaging see page 66 / Zusätzliche technische Daten und Verpackung siehe Seite 66

**NEW**  
Sub-miniature fuse-links for surface mounting Type MKF quick-acting F

directly solderable on printed circuit boards

**NEU**  
Kleinst-Sicherungseinsätze für Oberflächenmontage Typ MKF

flink F

direkt einlötbar auf Leiterplatten



1:1

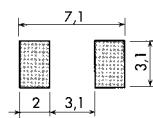
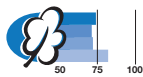
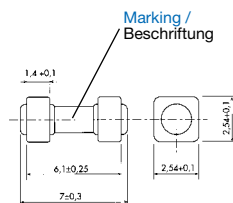

Solder pad / Anschlussflächen

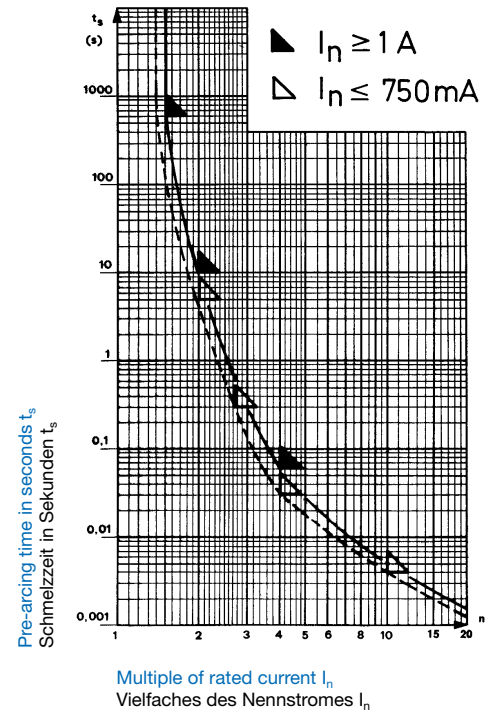

**Standards / Normen**

UL 248-14 (formerly / früher 198.G); CECC 00802

**Approvals / Approbationen**

UL CSA pending / angemeldet

**Pre-arcing time/current characteristic (at T<sub>a</sub> 23 °C)**

**Zeit-Strom-Charakteristik (bei T<sub>u</sub> 23 °C)**

Rated current I <sub>n</sub> / Nennstrom I <sub>n</sub>	n · I <sub>n</sub>					
	1 · I <sub>n</sub> *	1,5 · I <sub>n</sub>	2 · I <sub>n</sub>	2,75 · I <sub>n</sub>	4 · I <sub>n</sub>	10 · I <sub>n</sub>
	min.	max.	max.	max.	max.	max.
125 mA–750 mA	4 h		5 s	300 ms	30 ms	4 ms
1 A – 7 A	4 h	600 s	10 s		60 ms	

\* Non fusing current I<sub>nf</sub> / Kleiner Prüfstrom I<sub>nf</sub>

Order No. / Bestell-Nr.	Rated current I <sub>n</sub> / Rated voltage U <sub>n</sub> / Nennstrom I <sub>n</sub> - Nennspannung U <sub>n</sub>	Breaking capacity / Ausschaltvermögen	Voltage drop / Spannungsfall at / bei I <sub>n</sub> max.	Cold resistance / Kalt-Widerstand	Sustained power dissipation / Verlustleistung at / bei 1 · I <sub>n</sub> max.	Pre-arcing I <sup>2</sup> t / Schmelz I <sup>2</sup> t at / bei 10 · I <sub>n</sub>	Approvals / Approbationen
7010.9901.XX	125 mA / 125 V	300 A / 125 V AC p.f. / cos φ = 1 300 A / 125 V DC, L/R = 1 ms	750 mV	3400 mΩ	94 mW	2,4 · 10 <sup>-3</sup> A <sup>2</sup> s	UL CSA
7010.9902.XX	250 mA / 125 V		320	900	80	9,4 · 10 <sup>-3</sup>	• •
7010.9903.XX	375 mA / 125 V		240	440	90	2,1 · 10 <sup>-2</sup>	• •
7010.9904.XX	500 mA / 125 V		250	340	125	3,8 · 10 <sup>-2</sup>	• •
7010.9905.XX	750 mA / 125 V		220	200	165	8,5 · 10 <sup>-2</sup>	• •
7010.9906.XX	1 A / 125 V		180	130	180	1,5 · 10 <sup>-1</sup>	• •
7010.9907.XX	1,5 A / 125 V		210	96	315	4,5 · 10 <sup>-1</sup>	• •
7010.9908.XX	2 A / 125 V		170	61,5	340	9,5 · 10 <sup>-1</sup>	• •
7010.9909.XX	2,5 A / 125 V		165	46	413	1,4	• •
7010.9910.XX	3 A / 125 V		160	39	480	2,2	• •
7010.9911.XX	3,5 A / 125 V		160	29,5	560	2,8	• •
7010.9912.XX	4 A / 125 V		180	27,1	720	4	• •
7010.9913.XX	5 A / 125 V		170	20,1	850	6,8	• •
7010.9914.XX	7 A / 125 V		180	13	1260	10	• •

.XX Packaging index / Verpackungsindex

Additional technical data and packaging see page 66 / Zusätzliche technische Daten und Verpackung siehe Seite 66

FUSES / SICHERUNGEN

NON RESETTABLE / NICHT RÜCKSTELLEND

**Sub-miniature fuse-links for surface mounting Type MKT time-lag T**

directly solderable on printed circuit boards

**NEW**

**Kleinst-Sicherungseinsätze für Oberflächenmontage Typ MKT träge T**

direkt einlötlbar auf Leiterplatten

**NEU**



1:1

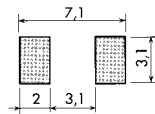
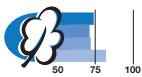
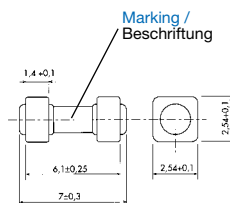

Solder pad / Anschlussflächen

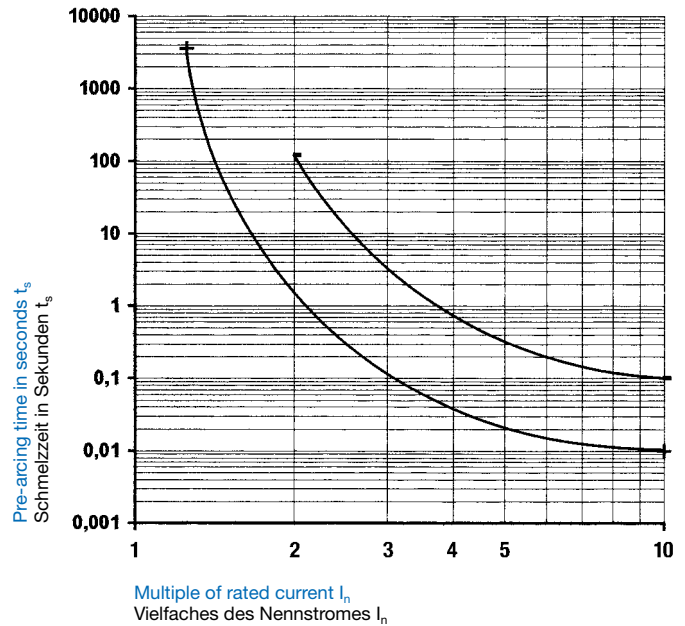

Standards / Normen

IEC 60127-4/2, EN 60127-4/2

Approvals / Approbationen

pending / angemeldet

Pre-arcing time/current characteristic (at  $T_a$  23 °C)

Zeit-Strom-Charakteristik (bei  $T_u$  23 °C)

Rated current $I_n$ / Nennstrom $I_n$	$n \cdot I_n$		$10 \cdot I_n$	
	min.	max.	min.	max.
2-6,3 A	1 h	120 s	10 ms	100 ms

\* Non fusing current  $I_{nf}$  / Kleiner Prüfstrom  $I_{nf}$

Order No. / Bestell-Nr.	Rated current $I_n$ / Rated voltage $U_n$ / Nennstrom $I_n$ / Nennspannung $U_n$	Breaking capacity / Ausschaltvermögen	Voltage drop / Spannungsfall at / bei $I_n$ max.	Sustained power dissipation / Verlustleistung at / bei $1 \cdot I_n$ max.	Pre-arcing $I^2t$ / Schmelz $I^2t$ at / bei $10 \cdot I_n$	Approvals / Approbationen
7010.9513.XX	2 A / 125 V	50 A / 125 V AC/DC	90	on request / auf Anfrage	5,1	pending / angemeldet
7010.9514.XX	2,5 A / 125 V		90		8,7	
7010.9515.XX	3,15 A / 125 V		85		15	
7010.9516.XX	3,5 A / 125 V		85		19	
7010.9517.XX	4 A / 125 V		80		27	
7010.9518.XX	5 A / 125 V		105		30	
7010.9519.XX	6,3 A / 125 V	63 A / 125 V AC/DC	85		81	

.XX Packaging index / Verpackungsindex

Additional technical data and packaging see page 66 / Zusätzliche technische Daten und Verpackung siehe Seite 66

**FUSES / SICHERUNGEN**
**NON RESETTABLE / NICHT RÜCKSTELLEND**
**Additional technical data / Zusätzliche technische Daten**

Ambient temperature max. $T_a$ / Zulässige Umgebungstemperatur $T_u$	- 55 °C ÷ + 85 °C
Solderability; Reflow-(infra-red and vapour phase) and wave soldering / Lötbarkeit; Reflow-(Infrarot- und Dampfphase) und Wellenlötung	235 °C / 2 sec. IEC 60068-2-58 / test / Test Td
Soldering heat resistance / Lötwärmebeständigkeit	260 °C / 5 sec. IEC 60068-2-58 / test / Test Td
Materials: Housing Terminals Werkstoffe: Gehäuse Anschlüsse	Ceramics Brass, tin-plated Keramik Cu Zn verzinkt
Net weight % / Nettogewicht %	172876, MSB = 7 g MKF, MKT = 14,5 g



Suitable surface mount fuseholder see page 188 /  
Passende oberflächenmontierbare Sicherungshalter siehe Seite 188

**Packaging / Verpackung:**

Types / Typen 172876 and / und MSB

Tube or tape / Röhrchen oder Gurt	
Tube of 100 pieces / Röhrchen à 100 Stück, lose geschüttelt	7010.XXXX.63
Taped and reeled 1500 pieces / Blistergurt à 1500 Stück auf Rolle	7010.XXXX.57

Types / Typen MKF and / und MKT

Bag or tape / Beutel oder Gurt	
Bag of 100 pieces / Beutel à 100 Stück	7010.XXXX.03
Taped and reeled 500 pieces / Blistergurt à 500 Stück auf Rolle	7010.XXXX.55
Taped and reeled 1500 pieces / Blistergurt à 1500 Stück auf Rolle	7010.XXXX.57

**Blistertape and reel / Blistergurt und Rolle**

according to IEC 60286-3 / gemäß IEC 60286-3

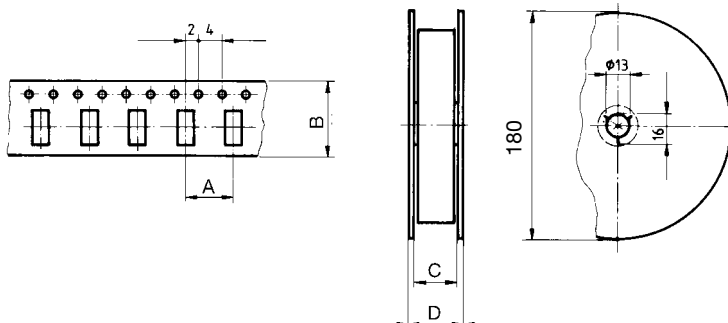

Types / Typen	Dimensions / Masse in mm			
	A	B	C (max.)	D (max.)
172876	4	12	12,4	18,4
MSB				
MKF				
MKT				

**Sub-miniature fuse-links with wire leads. Microfuse Type MSF 125 quick-acting F**

low breaking capacity directly solderable into printed circuit boards or plugable into fuseholders

**Kleinst-Sicherungseinsätze mit Drahtanschlüssen. Microfuse Typ MSF 125 flink F**

kleines Schaltvermögen direkt einlötlbar in Leiterplatten oder steckbar in Sicherungshalter

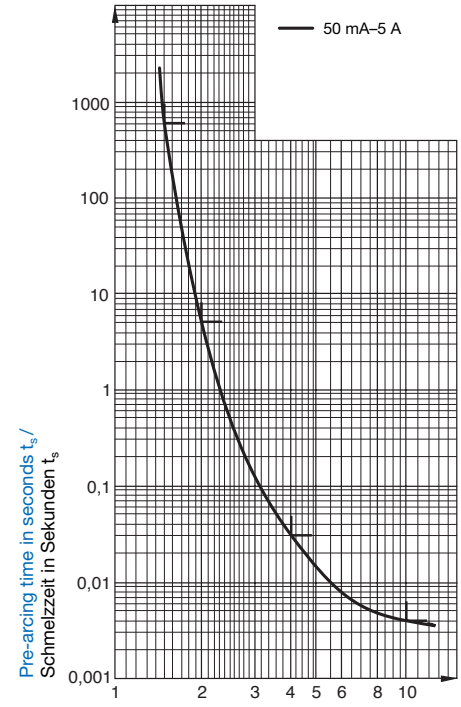
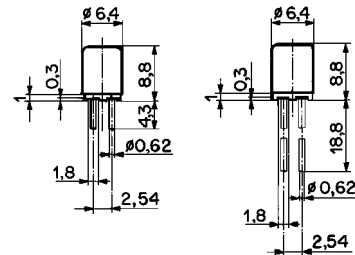

Pre-arcing time/current characteristic (at T<sub>a</sub> 23 °C)

Zeit-Strom-Charakteristik (bei T<sub>u</sub> 23 °C)

n · I <sub>n</sub>	1 · I <sub>n</sub> <sup>1</sup>	1,5 · I <sub>n</sub>	2,0 · I <sub>n</sub>	2,75 · I <sub>n</sub>	4 · I <sub>n</sub>	10 · I <sub>n</sub>
Rated current I <sub>n</sub> / Nennstrom I <sub>n</sub>	UL/IEC	UL	UL/IEC	IEC	IEC	IEC
0,05 – 5 A	continuous / dauernd	< 10 min.	< 5 s	< 300 ms	< 30 ms	< 4 ms

<sup>1</sup> Non fusing current I<sub>nf</sub> / Kleiner Prüfstrom I<sub>nf</sub>

**Approvals / Approbationen**



**Standards / Normen**

IEC 60127-3/1; EN 60127-3/1  
 UL 248-14 (formerly / früher 198.G)  
 CSA C22.2 No. 248.14 (formerly / früher 59.2 M)

with modifications based on IEC.../EN... / mit Modifikationen basierend auf IEC.../EN...

Order No. / Bestell-Nr.		Rated current I <sub>n</sub> / Rated voltage U <sub>n</sub> / Nennstrom I <sub>n</sub> / Nennspannung U <sub>n</sub>	Breaking capacity / Ausschaltvermögen	Voltage drop / Spannungsfall at / bei I <sub>n</sub>		Sustained power dissipation / Verlustleist. at / bei I <sub>n</sub>		Pre-arcing I <sup>2</sup> t / Schmelz I <sup>2</sup> t at / bei 10 · I <sub>n</sub>	Approvals / Approbationen	
Terminals / Anschlüsse short*** / kurz***	long / lang			max. IEC 60127 mV	typ. IEC 60127 mV	max. IEC 60127 mW	typ. IEC 60127 mW			
0034.4707*	0034.4708*	50 mA / 125 V	50 A / 125 V AC	800				7 · 10 <sup>-5</sup>	•	
0034.4209	0034.4239	100 mA / 125 V		1000	690	110	100	7 · 10 <sup>-4</sup>	• •	
0034.4210	0034.4240	125 mA / 125 V	IEC: 50 A/125 V AC/DC p.f. / cos w 1	1000	960	140	100	1,5 · 10 <sup>-3</sup>	• •	
0034.4211	0034.4241	160 mA / 125 V		1000	850	180	100	3,6 · 10 <sup>-3</sup>	• •	
0034.4212	0034.4242	200 mA / 125 V		700	680	140	100	3,3 · 10 <sup>-3</sup>	• •	
0034.4213	0034.4243	250 mA / 125 V		700	620	190	100	5,5 · 10 <sup>-3</sup>	• •	
0034.4214	0034.4244	315 mA / 125 V		700	680	240	200	2,5 · 10 <sup>-2</sup>	• •	
0034.4215	0034.4245	400 mA / 125 V		400	180	180	100	1,3 · 10 <sup>-2</sup>	• •	
0034.4216	0034.4246	500 mA / 125 V		400	180	220	100	2 · 10 <sup>-2</sup>	• •	
0034.4217	0034.4247	630 mA / 125 V		400	180	280	100	4,5 · 10 <sup>-2</sup>	• •	
0034.4218**	0034.4248**	710 mA / 125 V			140		100	4,5 · 10 <sup>-2</sup>	• •	
0034.4219**	0034.4249**	750 mA / 125 V			170		100	2 · 10 <sup>-2</sup>	• •	
0034.4220	0034.4250	800 mA / 125 V		UL/CSA: 300 A/125 V AC/DC p.f. / cos w 1	400	150	370	100	4 · 10 <sup>-2</sup>	• •
0034.4221	0034.4251	1 A / 125 V			190	150	210	100	7 · 10 <sup>-2</sup>	• •
0034.4222	0034.4252	1,25 A / 125 V			190	150	260	200	1,2 · 10 <sup>-1</sup>	• •
0034.4223	0034.4253	1,6 A / 125 V			190	150	330	200	2,9 · 10 <sup>-1</sup>	• •
0034.4224	0034.4254	2 A / 125 V	190		130	420	200	4,3 · 10 <sup>-1</sup>	• •	
0034.4225	0034.4255	2,5 A / 125 V	190		120	520	300	6 · 10 <sup>-1</sup>	• •	
0034.4226	0034.4256	3,15 A / 125 V	190		120	660	400	1,1	• •	
0034.4227	0034.4257	4 A / 125 V	190		120	840	500	1,9	• •	
0034.4228	0034.4258	5 A / 125 V	190		120	1000	600	3,0	• •	

\* Deviations / Abweichungen  
 • Time current characteristics: I<sub>n</sub> > 4h / Strom-Zeitkennwerte: I<sub>n</sub> > 4h  
 • Permissible continuous operating current: ≤ 0,7 · I<sub>n</sub> / Zulässiger Dauerstrom: ≤ 0,7 · I<sub>n</sub>

• Vibration and shock resistance: on request / Vibrations- und Schockbeständigkeit: auf Anfrage  
 • Cap: metal / Kappe: Metall

\*\* Not included in the standards / In den Normen nicht enthalten

\*\*\* Also available with transparent or metal caps / Auch mit transparenten oder Metallkappen lieferbar

Variable terminal lengths between 3 and 25,4 mm on request / Variablen Anschlusslängen zwischen 3 und 25,4 mm auf Anfrage

Additional technical data and packaging see page 71 / Zusätzliche technische Daten und Verpackung siehe Seite 71



Suitable fuseholders see page 189, 190 / Passende Sicherungshalter siehe Seite 189, 190

**Sub-miniature fuse-links with wire leads. Microfuse Type MSF 250**

**quick-acting F**  
low breaking capacity  
directly solderable into printed circuit boards or pluggable into fuseholders

**Kleinst-Sicherungseinsätze mit Drahtanschlüssen. Microfuse Typ MSF 250**

**flink F**  
kleines Schaltvermögen  
direkt einlötlbar in Leiterplatten oder steckbar in Sicherungshalter

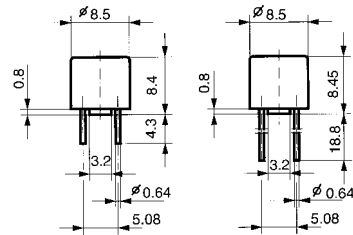
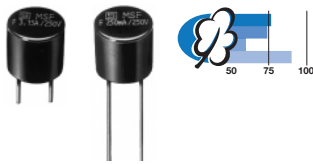

**Pre-arcing time/current characteristic (at T<sub>a</sub> 23 °C)**

**Zeit-Strom-Charakteristik (bei T<sub>u</sub> 23 °C)**

Rated current I <sub>n</sub> / Nennstrom I <sub>n</sub>	1,5 · I <sub>n</sub> *		2,1 · I <sub>n</sub>		2,75 · I <sub>n</sub>		4 · I <sub>n</sub>		10 · I <sub>n</sub>
	min.	max.	min.	max.	min.	max.	min.	max.	max.
40 mA – 5A	60 min	30 min	10 ms	3 s	3 ms	300 ms	20 ms		

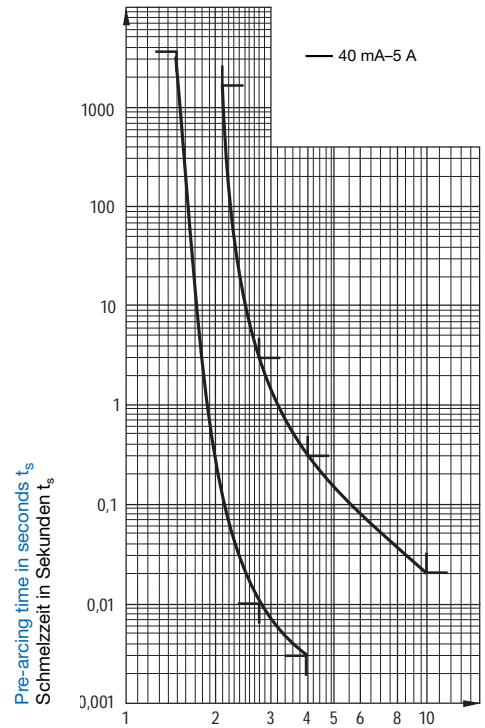

Multiple of rated current I<sub>n</sub>  
Vielfaches des Nennstromes I<sub>n</sub>

**Approvals / Approbationen**

- SEV
- UL
- VDE
- CSA
- SEMKO

\* Non fusing current I<sub>nf</sub> / Kleiner Prüfstrom I<sub>nf</sub>

**Standards / Normen**

IEC 60127-3/3; EN 60127-3/3  
 UL 248-14 (formerly / früher 198.G)  
 CSA C22.2 No. 248.14 (formerly / früher 59.2 M)

} with modifications based on IEC.../EN... /  
 } mit Modifikationen basierend auf IEC.../EN...

Order No. / Bestell-Nr.	Terminals / Anschlüsse		Rated current I <sub>n</sub> / Rated voltage U <sub>n</sub> / Nennstrom I <sub>n</sub> / Nennspannung U <sub>n</sub>	Breaking capacity / Ausschaltvermögen	Voltage drop / Spannungsfall at / bei I <sub>n</sub>		Sustained power dissipation / Verlustleist. at / bei 1,5 I <sub>n</sub>		Pre-arcing I <sup>2</sup> t / Schmelz I <sup>2</sup> t at / bei max. I <sub>n</sub>	Approvals / Approbationen
	short / kurz	long / lang			typ. IEC 60127 mV	typ. IEC 60127 mW	typ. IEC 60127 mW	typ. IEC 60127 A <sup>2</sup> s		
0034.6000*	0034.6030*	0034.6060*	40 mA / 250 V	35 A/250 V AC p.f. / cos w 1	–	400	–	90	1,6 · 10 <sup>-4</sup>	• •
0034.6001	0034.6031	0034.6061	50 mA / 250 V		850	460	110	100	4 · 10 <sup>-4</sup>	• • • • •
0034.6002	0034.6032	0034.6062	63 mA / 250 V		750	330	120	100	1 · 10 <sup>-3</sup>	• • • • •
0034.6003	0034.6033	0034.6063	80 mA / 250 V		650	280	140	100	1 · 10 <sup>-3</sup>	• • • • •
0034.6004	0034.6034	0034.6064	100 mA / 250 V		600	300	160	100	2 · 10 <sup>-3</sup>	• • • • •
0034.6005	0034.6035	0034.6065	125 mA / 250 V		550	210	180	100	6 · 10 <sup>-3</sup>	• • • • •
0034.6006	0034.6036	0034.6066	160 mA / 250 V		500	460	210	200	1,4 · 10 <sup>-2</sup>	• • • • •
0034.6007	0034.6037	0034.6067	200 mA / 250 V		480	470	250	200	2,4 · 10 <sup>-2</sup>	• • • • •
0034.6008	0034.6038	0034.6068	250 mA / 250 V		440	360	290	200	5,8 · 10 <sup>-2</sup>	• • • • •
0034.6009	0034.6039	0034.6069	315 mA / 250 V		400	345	330	300	1,04 · 10 <sup>-1</sup>	• • • • •
0034.6010	0034.6040	0034.6070	400 mA / 250 V		370	80	390	100	4,4 · 10 <sup>-2</sup>	• • • • •
0034.6011	0034.6041	0034.6071	500 mA / 250 V		350	75	460	100	9 · 10 <sup>-2</sup>	• • • • •
0034.6012	0034.6042	0034.6072	630 mA / 250 V		320	70	530	100	1,5 · 10 <sup>-1</sup>	• • • • •
0034.6013	0034.6043	0034.6073	800 mA / 250 V		300	70	630	100	2,2 · 10 <sup>-1</sup>	• • • • •
0034.6014	0034.6044	0034.6074	1 A / 250 V		280	70	740	200	3,3 · 10 <sup>-1</sup>	• • • • •
0034.6015	0034.6045	0034.6075	1,25 A / 250 V		280	65	920	200	6,8 · 10 <sup>-1</sup>	• • • • •
0034.6016	0034.6046	0034.6076	1,6 A / 250 V		250	70	1000	300	9,4 · 10 <sup>-1</sup>	• • • • •
0034.6017	0034.6047	0034.6077	2 A / 250 V		240	70	1360	300	1,3	• • • • •
0034.6018	0034.6048	0034.6078	2,5 A / 250 V		200	65	1310	400	1,9	• • • • •
0034.6019	0034.6049	0034.6079	3,15 A / 250 V		180	65	1490	500	5,4	• • • • •
0034.6020	0034.6050	0034.6080	4 A / 250 V	160	60	1680	1000	7,9	• •	
0034.6021	0034.6051	0034.6081	5 A / 250 V	150	60	1970	1000	11,2	• •	

\* Not included in the standards / In den Normen nicht enthalten

Additional technical data and packaging see page 71 / Zusätzliche technische Daten und Verpackung siehe Seite 71

Suitable fuseholder see page 191 / Passender Sicherungshalter siehe Seite 191

# FUSES / SICHERUNGEN

# NON RESETTABLE / NICHT RÜCKSTELLEND

**Sub-miniature fuse-links with wire leads. Microfuse Type MST 250**

**time-lag T**  
low breaking capacity  
directly solderable into printed circuit boards or plugable into fuseholders

**Kleinst-Sicherungseinsätze mit Drahtanschlüssen. Microfuse Typ MST 250**

**träge T**  
kleines Schaltvermögen  
direkt einlötlbar in Leiterplatten oder steckbar in Sicherungshalter

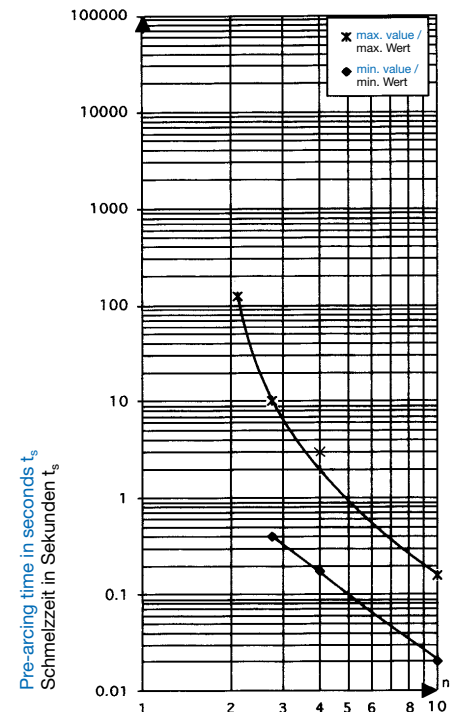
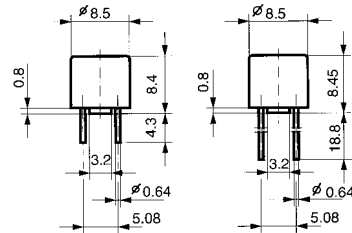

**Pre-arcing time/current characteristic (at T<sub>a</sub> 23 °C)**

**Zeit-Strom-Charakteristik (bei T<sub>U</sub> 23 °C)**

n · I <sub>n</sub>	1,5 · I <sub>n</sub> *		2,1 · I <sub>n</sub>		2,75 · I <sub>n</sub>		4 · I <sub>n</sub>		10 · I <sub>n</sub>	
	min.	max.	min.	max.	min.	max.	min.	max.	min.	max.
Rated current I <sub>n</sub> / Nennstrom I <sub>n</sub>	50 mA – 6,3A	60 min	2 min	400 ms	10 s	150 ms	3 s	20 ms	150 ms	

\* Non fusing current I<sub>nf</sub> / Kleiner Prüfstrom I<sub>nf</sub>

**Standards / Normen**

IEC 60127-3/4; EN 60127-3/4  
 UL 248-14 (formerly / früher 198.G) } with modifications based on IEC.../EN... /  
 CSA C22.2 No. 248.14 (formerly / früher 59.2 M) } mit Modifikationen basierend auf IEC.../EN...

**Approvals / Approbationen**

- SEV
- UL
- VDE
- CSA
- SEMKO

Order No. / Bestell-Nr.	Terminals / Anschlüsse		Taped and reeled / gegurtet auf Rollen	Rated current I <sub>n</sub> / Rated voltage U <sub>n</sub> / Nennstrom I <sub>n</sub> / Nennspannung U <sub>n</sub>	Breaking capacity / Ausschaltvermögen	Voltage drop / Spannungsfall at / bei I <sub>n</sub>		Sustained power dissipation / Verlustleistung at / bei 1,5 I <sub>n</sub>		Pre-arcing / Schmelz I <sup>2</sup> t at / bei 10 · I <sub>n</sub>	Approvals / Approbationen
	short / kurz	long / lang				max. IEC 60127 mV	typ.  mV	max. IEC 60127 mW	typ.  mW		
0034.6602		0034.6702	0034.6802	50 mA / 250 V	35 A/250 V AC p.f. / cos w 1	550	415	155	55	3 · 10 <sup>-2</sup>	
0034.6603		0034.6703	0034.6803	63 mA / 250 V		480	420	160	70	5 · 10 <sup>-2</sup>	
0034.6604		0034.6704	0034.6804	80 mA / 250 V		400	360	165	80	7 · 10 <sup>-2</sup>	
0034.6605		0034.6705	0034.6805	100 mA / 250 V		350	320	170	90	8 · 10 <sup>-2</sup>	
0034.6606		0034.6706	0034.6806	125 mA / 250 V		300	270	180	90	1,2 · 10 <sup>-1</sup>	
0034.6607		0034.6707	0034.6807	160 mA / 250 V		280	190	190	80	2,4 · 10 <sup>-1</sup>	
0034.6608		0034.6708	0034.6808	200 mA / 250 V		260	150	200	80	3,5 · 10 <sup>-1</sup>	
0034.6609		0034.6709	0034.6809	250 mA / 250 V		240	120	220	80	6 · 10 <sup>-1</sup>	
0034.6610		0034.6710	0034.6810	315 mA / 250 V		220	120	250	100	8 · 10 <sup>-1</sup>	
0034.6611		0034.6711	0034.6811	400 mA / 250 V		200	110	280	100	1,1	
0034.6612		0034.6712	0034.6812	500 mA / 250 V		190	100	310	100	2,5	
0034.6613		0034.6713	0034.6813	630 mA / 250 V		180	90	360	100	4	
0034.6614		0034.6714	0034.6814	800 mA / 250 V		160	80	430	200	8	
0034.6615		0034.6715	0034.6815	1 A / 250 V		140	70	500	200	12	
0034.6616		0034.6716	0034.6816	1,25 A / 250 V		130	70	600	300	15	
0034.6617		0034.6717	0034.6817	1,6 A / 250 V		120	60	730	300	30	
0034.6618		0034.6718	0034.6818	2 A / 250 V		100	60	870	300	34	
0034.6619		0034.6719	0034.6819	2,5 A / 250 V	100	50	1000	400	55		
0034.6620		0034.6720	0034.6820	3,15 A / 250 V	100	50	1200	500	76		
0034.6621		0034.6721	0034.6821	4 A / 250 V	100	50	1400	600	80		
0034.6622*		0034.6722*	0034.6822*	5 A / 250 V		50		900	230		
0034.6623*		0034.6723*	0034.6823*	6,3 A / 250 V		45		1100	360		

\* Not mentioned in the standards / In den Normen nicht enthalten

**Additional technical data and packaging see page 71 / Zusätzliche technische Daten und Verpackung siehe Seite 71**



Suitable fuseholder see page 191 / Passender Sicherungshalter siehe Seite 191

Sub-miniature fuse-links with wire leads. Microfuse Type MXT 250

time-lag T high breaking capacity directly solderable into printed circuit boards or plugable into fuseholders

Kleinst-Sicherungseinsätze mit Drahtanschlüssen. Microfuse Typ MXT 250

träge T grosses Schaltvermögen direkt einlötlbar in Leiterplatten oder steckbar in Sicherungshalter

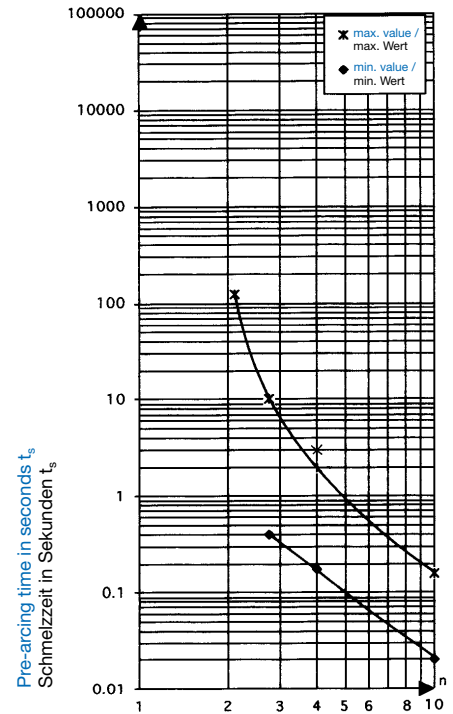
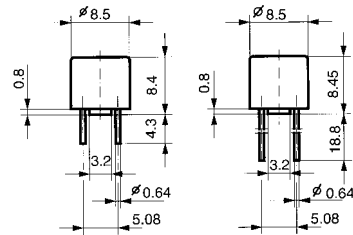

Standards / Normen

IEC 60127-3/4; EN 60127-3/4 however with a higher breaking capacity / jedoch mit einem höheren Schaltvermögen  
 UL 248-14 (formerly / früher 198.G)  
 CSA C22.2 No. 248.14 (formerly / früher 59.2 M)

with modifications based on IEC.../EN... / mit Modifikationen basierend auf IEC.../EN...

Approvals / Approbationen



Pre-arcing time/current characteristic (at T<sub>a</sub> 23 °C)

Zeit-Strom-Charakteristik (bei T<sub>a</sub> 23 °C)

n · I <sub>n</sub>	1,5 · I <sub>n</sub> *		2,1 · I <sub>n</sub>		2,75 · I <sub>n</sub>		4 · I <sub>n</sub>		10 · I <sub>n</sub>	
	min.	max.	min.	max.	min.	max.	min.	max.	min.	max.
0,8 – 6,3A	60 min	2 min	400 ms	10 s	150 ms	3 s	20 ms	150 ms		

\* Non fusing current I<sub>nf</sub> / Kleiner Prüfstrom I<sub>nf</sub>

Order No. / Bestell-Nr.	Terminals / Anschlüsse		Taped and reeled / gegurtet auf Rollen	Rated current I <sub>n</sub> / Rated voltage U <sub>n</sub> / Nennstrom I <sub>n</sub> / Nennspannung U <sub>n</sub>	Breaking capacity / Ausschaltvermögen	Voltage drop / Spannungsfall at / bei I <sub>n</sub>		Sustained power dissipation / Verlustleist. at / bei 1,5 I <sub>n</sub>		Pre-arcing I <sup>2</sup> t / Schmelz I <sup>2</sup> t at / bei 10 · I <sub>n</sub>	Approvals / Approbationen
	short / kurz	long / lang				max. IEC 60127 mV	typ. IEC 60127 mV	max. IEC 60127 mW	typ. IEC 60127 mW		
0034.6914		0034.6944	0034.6974	800 mA / 250 V	100 A/250 V AC p.f. / cos w 1	160	150	430	300	2,2	• • • • •
0034.6915		0034.6945	0034.6975	1 A / 250 V		140	130	500	350	4,4	• • • • •
0034.6916		0034.6946	0034.6976	1,25 A / 250 V		130	120	600	400	6,3	• • • • •
0034.6917		0034.6947	0034.6977	1,6 A / 250 V		120	110	730	500	10	• • • • •
0034.6918		0034.6948	0034.6978	2 A / 250 V		100	85	870	500	16	• • • • •
0034.6919		0034.6949	0034.6979	2,5 A / 250 V		100	85	1000	650	32	• • • • •
0034.6920		0034.6950	0034.6980	3,15 A / 250 V		100	75	1200	670	57	• • • • •
0034.6921		0034.6951	0034.6981	4 A / 250 V		100	75	1400	900	77	• • • • •
0034.6922		0034.6952	0034.6982	5 A / 250 V			70		1100	155	• • • • •
0034.6923		0034.6953	0034.6983	6,3 A / 250 V			65		1150	262	• • • • •

Additional technical data and packaging see page 71 / Zusätzliche technische Daten und Verpackung siehe Seite 71

Suitable fuseholder see page 191 / Passender Sicherungshalter siehe Seite 191



**Technical data and packaging**
**Types** MSF 125  
 MSF 250  
 MST 250  
 MXT 250

**Technische Daten und Verpackung**
**Typen** MSF 125  
 MSF 250  
 MST 250  
 MXT 250

**Additional technical data / Zusätzliche technische Daten**

<b>Ambient temperature max. <math>T_a</math></b> Zulässige Umgebungstemperatur $T_u$	MSF 125: - 25 °C to / bis + 85 °C MSF / MST / MXT 250: - 40 °C to / bis + 85 °C
<b>Permissible continuous operating current at 23 °C /</b> Zulässiger Dauerstrom bei 23 °C	MSF 125: $0,7 \cdot I_n$ Shift of the rated current at ambient air temperatures MSF / MST / MXT 250: $1 \cdot I_n$ > 23 °C see diagramm on page 44 Verschiebung des Nennstromes bei Umgebungstemperaturen > 23 °C siehe Diagramm Seite 44
<b>Resistance to vibration</b>  Vibrationsbeständigkeit	Frequency 10 ÷ 2000 Hz, cross-over frequency 60 Hz < 60 Hz constant amplitude of 1,5 mm (except MSF 125: 0,75 mm) > 60 Hz constant acceleration of 100 m/s <sup>2</sup> (10 g) according to IEC 60068-2-6, test Fc  Frequenzbereich 10 ÷ 2000 Hz, Übergangsfrequenz 60 Hz < 60 Hz konstante Amplitude von 1,5 mm (ausser MSF 125: 0,75 mm) > 60 Hz konstante Beschleunigung von 100 m/s <sup>2</sup> (10 g) nach IEC 60068-2-6, Test Fc
<b>Resistance to shock</b> Schockbeständigkeit	490 m/s <sup>2</sup> (50 g), 11 ms according to / nach IEC 60068-2-27
<b>Climate category</b> Klimakategorie	Types / Typen MSF 125 HPF MXT 250 } according to / nach DIN 40040 MSF 250 } GPF MST 250 }
<b>Solderability</b> Lötbarkeit	235 °C / 2 sec. according to IEC 60068-2-20, test Ta 235 °C / 2 sec. nach IEC 60068-2-20, Test Ta
<b>Soldering heat resistance</b> Lötwärmebeständigkeit	260 °C / 10 sec. according to IEC 60068-2-20, test Tb 260 °C / 10 sec. nach IEC 60068-2-20, Test Tb
<b>Materials</b> Socket and cap Werkstoff Sockel und Kappe  Terminals Anschlüsse	temperature resistant plastic, UL 94V-0 temperaturbeständiger Kunststoff; UL 94V-0  Copper tin-plated Kupfer verzinnt

**Packaging / Verpackung**

- Boxes of 100 pieces / Lose geschüttet à 100 Stück
- Taped and reeled 750 pieces / Gegurtet auf Rollen à 750 Stück  
 MSF 125, 1000 pieces / MSF 125 à 1000 Stück

**Tape and reel / Gurt und Rolle**

according to IEC 60286-2 / gemäss IEC 60286-2

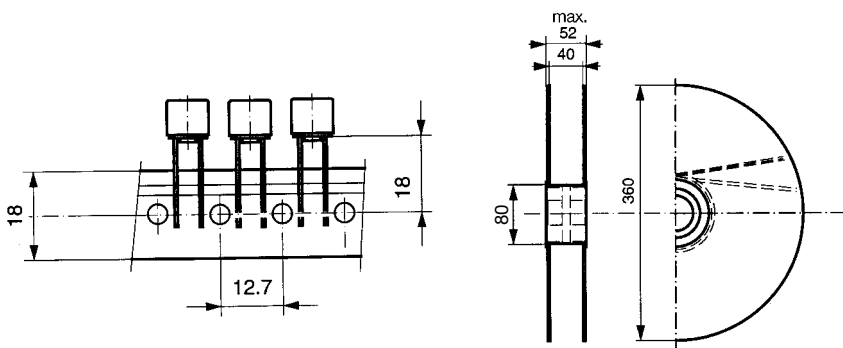

Sub-miniature fuse-links with wire leads. Type 172322<sup>1</sup> quick-acting F

Kleinst-Sicherungseinsätze mit Drahtanschlüssen. Typ 172322<sup>1</sup> flink F

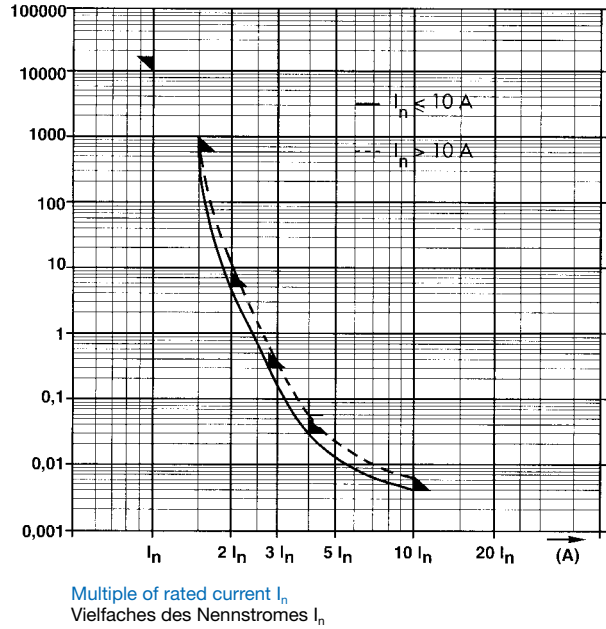
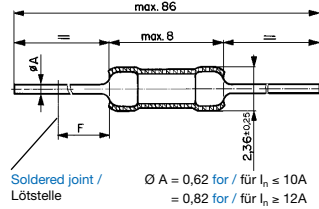
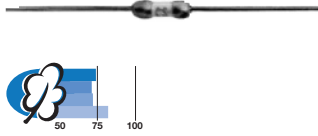

Standards / Normen

IEC 60127-3/2; EN 60127-3/2  
UL 248-14 (formerly / früher 198.G)  
CSA C22.2 No. 248.14 (formerly / früher 59.2 M)

Approvals / Approbationen

UL CSA  
Lists / Listen: GAMT1

Pre-arcing time/current characteristic (at T<sub>a</sub> 23 °C)

Zeit-Strom-Charakteristik (bei T<sub>u</sub> 23 °C)

n · I <sub>n</sub>	1 · I <sub>n</sub> *	1,5 · I <sub>n</sub> **	2 · I <sub>n</sub>	2,75 · I <sub>n</sub>	4 · I <sub>n</sub>	10 · I <sub>n</sub>
Rated current I <sub>n</sub> / Nennstrom I <sub>n</sub>	min.	max.	max.	max.	max.	max.
≤ 10 A	4 h	600 s	5 s	300 ms	30 ms	4 ms
> 10 A	4 h	600 s	10 s		60 ms	

\* Non fusing current I<sub>nf</sub> / Kleiner Prüfstrom I<sub>nf</sub>  
\*\* Only according to UL / Nur nach UL

Order No. / Bestell-Nr.	Rated current I <sub>n</sub> / Rated voltage U <sub>n</sub> / Nennstrom I <sub>n</sub> / Nennspannung U <sub>n</sub>	Breaking capacity / Ausschaltvermögen	Voltage drop / Spannungsfall at / bei 1 I <sub>n</sub> max. / mV	Sustained power dissipation / Verlustleistung at / bei 1 I <sub>n</sub> max. / mW	Pre-arcing I <sup>2</sup> t / Schmelz I <sup>2</sup> t at / bei 10 · I <sub>n</sub> / A <sup>2</sup> s	Approvals / Approbationen / UL / CSA / GAMT1
7010.7010.XX	1/16 A* / 125 V	UL: 1/16 – 10 A: 50 A / 125 V AC p.f. / cos w 0,95 300 A / 125 V DC 12 A +15 A: 50 A / 32 V AC p.f. / cos w 0,95 300 A / 32 V DC	1050	66	8 · 10 <sup>-4</sup>	• •
7010.7020.XX	1/8 A* / 125 V		900	115	3,6 · 10 <sup>-3</sup>	• • •
7010.7030.XX	1/4 A* / 125 V		325	82	9,4 · 10 <sup>-3</sup>	• • •
7010.7040.XX	3/8 A / 125 V		245	92	1,9 · 10 <sup>-2</sup>	• • •
7010.7050.XX	1/2 A* / 125 V		260	130	7 · 10 <sup>-2</sup>	• • •
7010.7060.XX	3/4 A / 125 V		245	185	1,8 · 10 <sup>-1</sup>	• • •
7010.7070.XX	1 A* / 125 V		210	210	3 · 10 <sup>-1</sup>	• • •
7010.7080.XX	1 1/2 A / 125 V		230	345	3,8 · 10 <sup>-1</sup>	• • •
7010.7090.XX	2 A* / 125 V		190	380	1,1	• • •
7010.7100.XX	2 1/2 A* / 125 V		175	440	1,4	• • •
7010.7110.XX	3 A / 125 V	170	510	2	• • •	
7010.7180.XX	3 1/2 A / 125 V	CSA: 1/16 – 10 A: 300 A / 125 V AC/DC p.f. / cos w 0,95 12 A +15 A: 300 A / 32 V AC/DC p.f. / cos w 0,95	160	560	2,6	• • •
7010.7120.XX	4 A* / 125 V		180	720	4	• • •
7010.7130.XX	5 A* / 125 V		170	850	6,2	• • •
7010.7140.XX	7 A / 125 V		135	945	13	• • •
7010.7150.XX	10 A / 125 V		130	1300	39	• • •
7010.7160.XX	12 A / 32 V		120	1450	57	• • •
7010.7170.XX	15 A / 32 V		120	1800	90	• • •

.XX Packaging index / Verpackungsindex

\* Rated currents of IEC / IEC-Nennströme

<sup>1</sup> substitute type Minifuse MSA, Order No.: 0034.4807-0034.4886 from SCHURTER AG / ersetzt Typ Minifuse MSA, Bestell-Nummern 0034.4807-0034.4886 von SCHURTER AG

**FUSES / SICHERUNGEN**
**NON RESETTABLE / NICHT RÜCKSTELLEND**

**Sub-miniature  
fuse-links  
with wire leads.  
Type 172322**

**Kleinst-Sicherungs-  
einsätze mit Draht-  
anschlüssen.  
Typ 172322**

**Additional technical data / Zusätzliche technische Daten**

Ambient temperature max. T <sub>a</sub> Zulässige Umgebungstemperatur T <sub>u</sub>		- 55 °C to / bis + 85 °C	
Materials: Werkstoffe:		Ceramic / Keramik Hot resistant plastic / wärmebeständiger Kunststoff Brass, tin plated / Cu Zn, verzinkt Copper, tin-plated / Cu, verzinkt	
Insulated tube / Isolierrohr Insulated shroud / Isolierschlauch Caps / Kappen Terminals / Anschlüsse			
Solderability and soldering conditions according to IEC 60068-2-20 by thermal shield 1,5 mm thickness / Lötbarkeit / -bedingungen nach IEC 60068-2-20 (mit Wärmeschild 1,5 mm dick)			
Soldering method / Lötmethode	Soldering temperature / Löttemperatur	Distance body to soldered joint F / Abstand Körper zu Lötstelle F	max. soldering time / max. Lötzeit
Wave bath / Wellenbad	260 °C	≥ 3 mm	10 s
Soldering iron / LötKolben	350 °C	≥ 6 mm	3,5 s
Net weight % / Nettogewicht %		32 g: I <sub>n</sub> 1/16 – 10 A 46 g: I <sub>n</sub> > 10 A	

**Packaging see page 75 / Verpackung siehe Seite 75**

Sub-miniature fuse-links with wire leads. Type 172321 quick-acting F

Kleinst-Sicherungseinsätze mit Drahtanschlüssen. Typ 172321 flink F

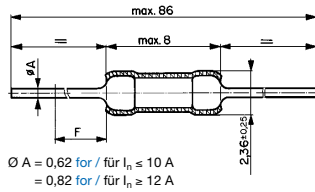
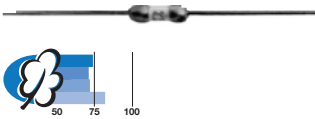

Standards / Normen

NF C 93-435 · Model HA81

Approvals / Approbationen

Qualification approval certificate of quality (CCQ) / Qualitätszertifikat (CCQ)

Lists / Listen: GAMT1

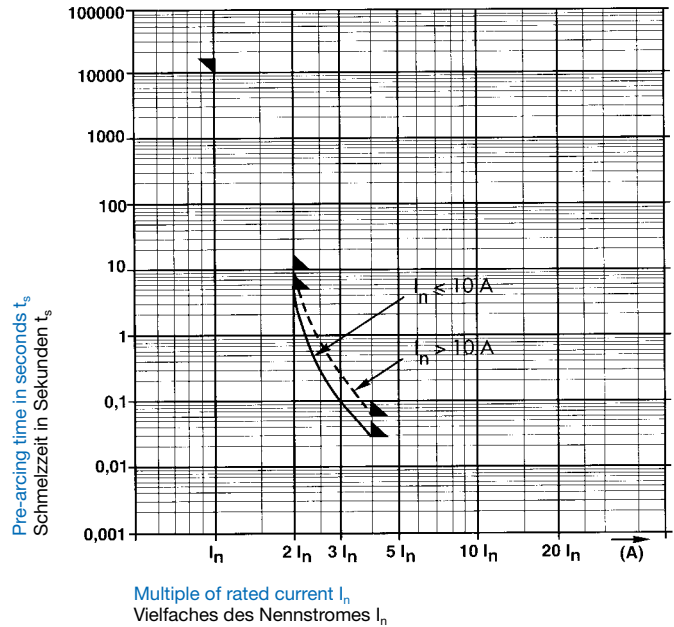

Pre-arcing time/current characteristic (at T<sub>a</sub> 23 °C)

Zeit-Strom-Charakteristik (bei T<sub>u</sub> 23 °C)

Rated current I <sub>n</sub> / Nennstrom I <sub>n</sub>	n · I <sub>n</sub>		
	1 · I <sub>n</sub>	2 · I <sub>n</sub>	4 · I <sub>n</sub>
	min.	max.	max.
1/16 – 10A	4 h	5 s	30 ms
12 – 15 A	4 h	10 s	60 ms

Technical data

Construction Ceramic tube, insulated shroud  
 Weight I<sub>n</sub> ≤ 10 A - 0,32 g  
 I<sub>n</sub> > 10 A - 0,46 g  
 Permissible environmental temperature -55 °C / + 85 °C  
 Climatic range 55 / 85 / 56 (IEC 60068-1 / IEC 60068-2)  
 Vibrations NF C 20-706 / IEC 60068-2-6:  
 10-2000 Hz / 0,75 mm / 10 cycles  
 NF C 20-727 / IEC 60068-2-27/50 g  
 Shocks NF C 20-711 / IEC 60068-2-11/Test Ka: 96 h  
 Salt mist 1000 h / I<sub>n</sub> / 25 °C/240 h / 0,9 I<sub>n</sub> / 85 °C  
 Electrical endurance Axial (support type 171338) Radial  
 Mounting conditions NF C 60-720 / IEC 60068-2-20  
 Soldering conditions Wave 260 °C / 3 mm / 10 s  
 Soldering method Soldering iron 350 °C / 6 mm / 3,5 s

Technische Daten

Konstruktion Keramikkörper, transparenter Isolierschlauch  
 Gewicht I<sub>n</sub> ≤ 10 A - 0,32 g  
 I<sub>n</sub> > 10 A - 0,46 g  
 Zulässige Umgebungstemperatur -55 °C / + 85 °C  
 Klimakategorie 55 / 85 / 56 (IEC 60068-1 / IEC 60068-2)  
 Vibrationsbeständigkeit NF C 20-706 / IEC 60068-2-6:  
 10-2000 Hz / 0,75 mm / 10 Perioden  
 Schockbeständigkeit NF C 20-727 / IEC 60068-2-27/50 g  
 Salznebel NF C 20-711 / IEC 60068-2-11/Versuch Ka: 96 h  
 Lebensdauer 1000 h / I<sub>n</sub> / 25 °C/240 h / 0,9 I<sub>n</sub> / 85 °C  
 Montage-Bedingung Axial (Halter Typ 171338) Radial  
 Löt-Bedingung NF C 60-720 / IEC 60068-2-20  
 Löt-Methode Wellenbad 260 °C / 3 mm / 10 s  
 LötKolben 350 °C / 6 mm / 3,5 s

**FUSES / SICHERUNGEN**
**NON RESETTABLE / NICHT RÜCKSTELLEND**

Order No. / Bestell-Nr.	Rated current $I_n$ / Rated voltage $U_n$ / Nennstrom $I_n$ / Nennspannung $U_n$	Breaking capacity / Ausschaltvermögen	Voltage drop / Spannungsfall at / bei $I_n$ max.	Sustained power dissipation / Verlustleistung at / bei $1 \cdot I_n$ max.	Pre-arcing $t^2$ / Schmelz $t^2$ at / bei $10 \cdot I_n$	Approvals / Approba- tionen
			mV	mW	A <sup>2</sup> s	CCC GAMT
7010.6300.XX	0,063 ( <sup>1</sup> / <sub>16</sub> ) A / 125 V AC/DC	300 A / 125 V AC/DC p.f. / cos $\phi$ 1 L/R = 1 ms	570	36	$1,4 \cdot 10^{-3}$	
7010.6310.XX	0,125 ( <sup>1</sup> / <sub>8</sub> ) A / 125 V AC/DC		720	90	$4,5 \cdot 10^{-3}$	•
7010.6320.XX	0,250 ( <sup>1</sup> / <sub>4</sub> ) A / 125 V AC/DC		215	54	$1,4 \cdot 10^{-2}$	•
7010.6330.XX	0,375 ( <sup>3</sup> / <sub>8</sub> ) A / 125 V AC/DC		185	70	$2,5 \cdot 10^{-2}$	•
7010.6340.XX	0,500 ( <sup>1</sup> / <sub>2</sub> ) A / 125 V AC/DC		180	90	$1,0 \cdot 10^{-1}$	•
7010.6350.XX	0,750 ( <sup>3</sup> / <sub>4</sub> ) A / 125 V AC/DC		155	120	$2,8 \cdot 10^{-1}$	• •
7010.6360.XX	1 A / 125 V AC/DC		160	160	$3,9 \cdot 10^{-1}$	• •
7010.6370.XX	1,5 (1 <sup>1</sup> / <sub>2</sub> ) A / 125 V AC/DC		165	250	$5,2 \cdot 10^{-1}$	• •
7010.6380.XX	2 A / 125 V AC/DC		160	320	1,3	• •
7010.6390.XX	2,5 (2 <sup>1</sup> / <sub>2</sub> ) A / 125 V AC/DC		145	365	1,6	• •
7010.6400.XX	3 A / 125 V AC/DC		140	420	2,4	•
7010.6410.XX	4 A / 125 V AC/DC		125	500	5,7	•
7010.6420.XX	5 A / 125 V AC/DC		120	600	8,7	•
7010.6440.XX	7 A / 125 V AC/DC		110	770	15	•
7010.6470.XX	10 A / 125 V AC/DC		110	1100	46	•
7010.6480.XX	12 A / 32 V AC/DC	120	1450	57	•	
7010.6490.XX	15 A / 32 V AC/DC	110	1650	98	•	

.XX Packaging index / Verpackungsindex

**Packaging / Verpackung**

Order No. / Bestell-Nr.: 7010.XXXX.XX

**Standard quantities / Standardmengen**

3 = 100 pcs / Stück  
7 = 1500 pcs / Stück  
9 = 5000 pcs / Stück

**Diameter D of spool / Durchmesser D der Rolle**

192 mm  
360 mm

**Box or tape / Schachtel oder Gurt**

1 = Box / Schachtel  
3 = Tape / Band, L = 53 mm  
4 = Tape / Band, L = 73 mm  
8 = Tape / Band, L = 63 mm

According to standards / gemäss Normen: NF C 90.520 / IEC 60286-1

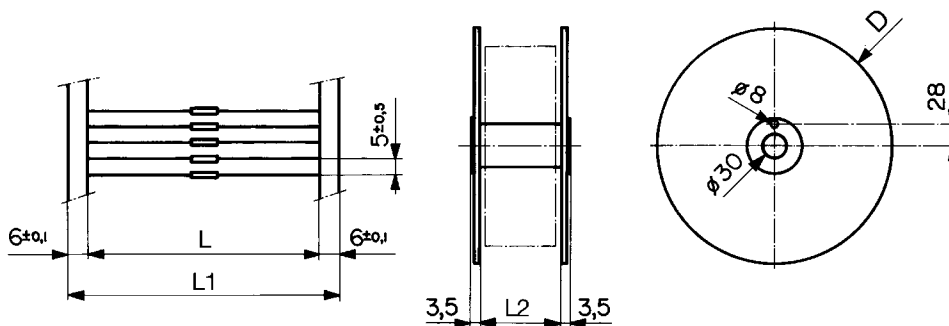

Dimensions in mm / Dimensionen in mm

L	L1	L2
73 ± 2	85 ± 2	90
53 ± 2	65 ± 2	70
63 ± 2	75 ± 2	80

FUSES / SICHERUNGEN

NON RESETTABLE / NICHT RÜCKSTELLEND

Sub-miniature fuse-links with wire leads. Type 172321S Space applications quick-acting F

Kleinst-Sicherungseinsätze mit Drahtanschlüssen. Typ 172321S Raumfahrt-Anwendungen flink F

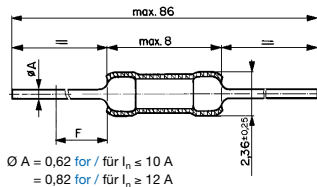
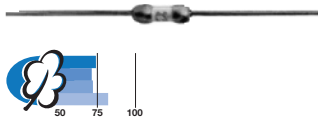

Pre-arcing time/current characteristic (at T<sub>a</sub> 23 °C)

Rated current I <sub>n</sub> / Nennstrom I <sub>n</sub>	n · I <sub>n</sub>	
	2 · I <sub>n</sub>	4 · I <sub>n</sub>
	max.	max.
1/18 – 10 A	5 s	30 ms
15 A	10 s	60 ms

Zeit-Strom-Charakteristik (bei T<sub>a</sub> 23 °C)

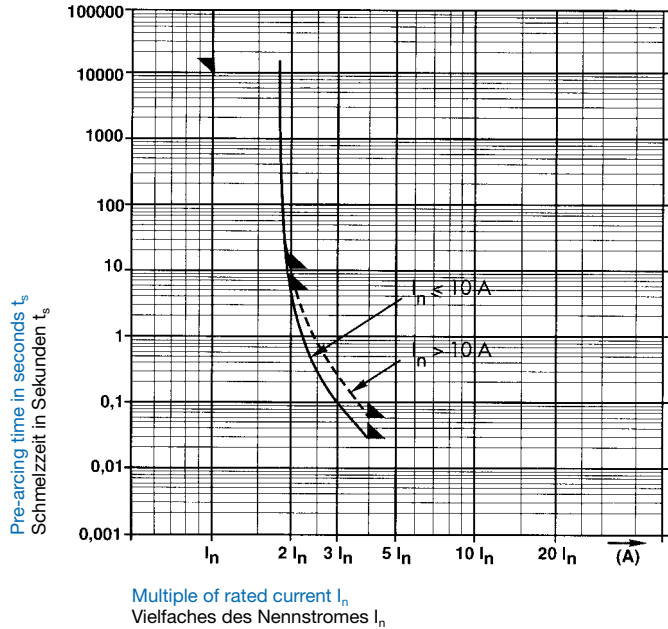

Standards / Normen

Draft ESA-SCC 4008

Approvals / Approbationen

Lists / Listen: GAMT1, Preferential / bevorzugt by / durch CNES

Technical data

Construction: Ceramic tube, Connections copper tin-plated, Caps brass tin-plated, Insulat. sleeve  
 Weight: 1/8 to 10 A: 0,32 g, 15 A: 0,46 g  
 Climatic range: 55 / 125 / 56 (434)  
 Uprating: 1,1 rated current at -55 °C  
 Derating: 0,8 rated current at +125 °C  
 Vibrations: NF C 20-706, IEC 60068-2-16 / procedure B4, 10-3000 Hz / 1,5 mm / 12 cycles  
 Shocks: NF C 20-727 / IEC 60068-2-27, 12 shocks to 100 g (6 ms)  
 Solidity of the terminals: NF C 20-721 / IEC 60068-2-21, test Ua - 10 N - 10 s  
 Operating life: 2000 h rated current at 25 °C  
 Burn-in test: rated current at 25 °C, 90 mn "ON" - 30 mn "OFF" total duration: 168 h  
 Seal test: NF C 20-717 / IEC 60068-2-17, method 2  
 Radiography: ESA / SCC 20900  
 Rapid change of temperature: NF C 20-714 / IEC 60068-2-14, 30 mn  
 Insulation resistance: 500 kΩ mini / 500 V

Technische Daten

Konstruktion: Keramikkörper, Verbindung Cu, verzinkt  
 Gewicht: Klemme Messing versilbert, Schrumpfschlauch  
 Klimakategorie: 1/8 zu 10 A: 0,32 g, 15 A: 0,46 g  
 Uprating: 55 / 125 / 56 (434)  
 Derating: 1,1 bei -55 °C  
 Vibrationsbeständigkeit: 0,8 bei +125 °C  
 Schockbeständigkeit: NF C 20-706, IEC 60068-2-16 / Prozedur B4, 10-3000 Hz / 1,5 mm / 12 Perioden  
 Festigkeit der Anschlüsse: NF C 20-721 / IEC 60068-2-21, Test Ua - 10 N - 10 s  
 Lebensdauer: 2000 h I<sub>n</sub> bei 25 °C  
 Burn-in-test: I<sub>n</sub> bei 25 °C, 90 mn «ON» - 30 mn «OFF»  
 Dichttheit: Versuch: 168 h  
 Radiographie: NF C 20-717 / IEC 60068-2-17, Methode 2  
 Rascher Temperaturwechsel: ESA / SCC 20900  
 Isolationswiderstand: NF C 20-714 / IEC 60068-2-14, 30 mn  
 500 kΩ mini / 500 V

Order No. / Bestell-Nr.	Rated current I <sub>n</sub> / Rated voltage U <sub>n</sub> / Nennstrom I <sub>n</sub> / Nennspannung U <sub>n</sub>	Voltage drop / Spannungsfall at / bei I <sub>n</sub> max. mV	Approvals / Approbationen CNES GAMT1
7010.6960.XX	0,125 (1/8) A / 125 V	2387	• •
7010.6970.XX	0,250 (1/4) A / 125 V	822	• •
7010.6830.XX	0,375 (3/8) A / 125 V	660	• •
7010.6840.XX	0,500 (1/2) A / 125 V	283	• •
7010.6850.XX	0,750 (3/4) A / 125 V	186	• •
7010.6860.XX	1 A / 125 V	175	• •
7010.6870.XX	1,5 (1 1/2) A / 125 V	162	• •
7010.6880.XX	2 A / 125 V	153	• •
7010.6890.XX	2,50 (2 1/2) A / 125 V	147	• •
7010.6900.XX	3 A / 125 V	142	• •
7010.6910.XX	4 A / 125 V	136	• •
7010.6920.XX	5 A / 125 V	131	• •
7010.6930.XX	7 A / 125 V	125	• •
7010.6940.XX	10 A / 125 V	120	• •
7010.6950.XX	15 A / 32 V	115	• •

.XX Packaging index, 60 ± 1 piece in a tube / Verpackungsindex, 60 ± 1 Stück in einem Röhrchen

**NEW**

**NEU**

**Sub-miniature fuse with wire leads Type MGL super-quick-acting FF**

**Kleinst-Sicherung mit Drahtanschlüssen**

**Typ MGL superflink FF**

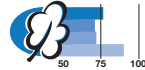

Mounting holes as close as .2 inch  
Lowest resistance  
Hermetically sealed for operating temperatures in excess of 150 °C  
Superior cycling

Montagelochdistanz in einem Abstand von .2 inch (5,08 mm) möglich  
Kleinsten Innenwiderstand  
Hermetisch dicht für Einsatztemperaturen bis zu 150 °C

**Approvals, Patents / Approbationen, Patente**

UL recognition 200mA-3A<sup>1)</sup> File # E153466  
 CSA acceptance 200mA-3A<sup>1)</sup> File # LR106903

<sup>1)</sup> 4A-5A approvals pending / 4A-5A in Prüfung

US 4.749.980 US 5.032.817 US 5.131.137  
US 4.860.437 US 5.040.284 US 5.155.462  
US 4.926.543 US 5.097.245 US 5.224.261  
US 5.001.451 US 5.122.774 US 5.272.804 US 5.027.101

Patents in US. and in further countries / Patente in U. S. und weiteren Ländern

**Typical Time to Trip at 23°C / Typische Auslösezeiten bei 23°C**

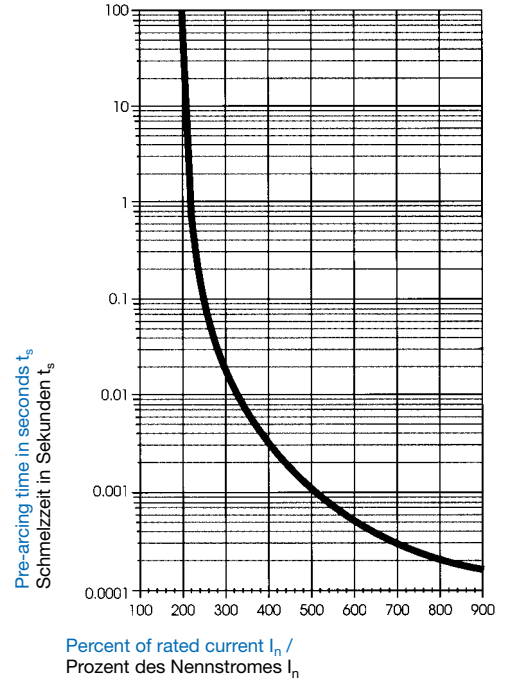

**Standards / Normen**

UL 248-14 (formerly / früher 198.G)  
CSA C22.2 No. 248.14 (formerly / früher 59.2 M)

**Pre-arcing time/current characteristic (at T<sub>a</sub> 23 °C)**

**Zeit-Strom-Charakteristik (bei T<sub>u</sub> 23 °C)**

$n \cdot I_n$	$1 \cdot I_n$	$2,5 \cdot I_n$
Rated current I <sub>n</sub> / Nennstrom I <sub>n</sub>		
200 mA-5 A	≥ 4 h	≤ 5 s

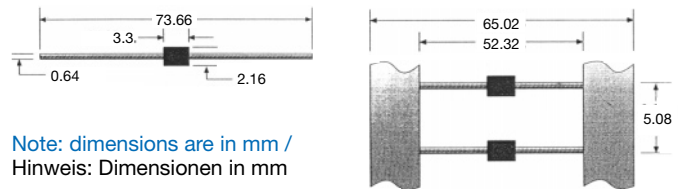

Note: dimensions are in mm / Hinweis: Dimensionen in mm

**Technical data**

Rated current see chart  
Time current characteristic super-quick-acting  
Interrupt capacity 50 A AC, 300 A DC  
Ambient temperature max. + 150 °C  
Climatic category hermetically sealed  
Solderability reflow: 260 °C / 30 sec. max; wave 260 °C / 10 sec. max.  
Soldering heat resistance 60 seconds above 200 °C, max. 260 °C  
Material: Housing ceramic  
Terminals nickel, tin-lead coated (silver coated optional)

**Technische Daten**

Nennstrom siehe Tabelle  
Auslösecharakteristik super-flink  
Ausschaltvermögen 50 A AC, 300 A DC  
Max. Umgebungstemperat. + 150 °C  
Klimakategorie hermetisch dicht  
Lötbarkeit reflow: 260 °C / 30 sek. max; Wellenlötung 260 °C / 10 sek. max.  
Lötwärmebeständigkeit 60 Sekunden über 200 °C, max. 260 °C  
Material: Gehäuse Keramik  
Anschluss Nickel, Zinn-Blei-Legierung (silver coated optional)

Order No. / Bestell-Nr.	Rated current I <sub>n</sub> / Rated voltage U <sub>n</sub> / Nennstrom I <sub>n</sub> / Nennspannung U <sub>n</sub>	Breaking capacity / Ausschaltvermögen	Voltage drop / Spannungsfall at / bei 1 · I <sub>n</sub>	Resistance / Widerstand at / bei ≤ 10% I <sub>n</sub>	Pre-arcing I <sup>2</sup> t / Schmelz I <sup>2</sup> t at / bei 4 · I <sub>n</sub>	Packaging Order No. Suffix / Verpackung
3411.0021.XX	200 mA / 125 V	50 A AC / 300 A DC	197	0,87	0,0013	packaged lose: .XX = .05 lose verpackt: .XX = .05
3411.0022.XX	250 mA / 125 V		168	0,63	0,0027	
3411.0025.XX	375 mA / 125 V		130	0,32	0,0039	
3411.0027.XX	500 mA / 125 V		115	0,20	0,0066	
3411.0029.XX	750 mA / 125 V		106	0,11	0,015	2500 pieces taped & reeled: .XX = .06 2500 Stück gegurtet auf Rollen .XX = .06
3411.0031.XX	1 A / 125 V		119	0,10	0,042	
3411.0033.XX	1,5 A / 125 V		106	0,06	0,12	
3411.0035.XX	2 A / 125 V		101	0,04	0,20	
3411.0036.XX	2,5 A / 125 V		98	0,03	0,35	5000 pieces taped & reeled: .XX = .07 5000 Stück gegurtet auf Rollen .XX = .07
3411.0037.XX	3 A / 125 V		96	0,02	0,55	
3411.0140.XX	4 A / 32 V		94	0,02	0,85	
3411.0141.XX	5 A / 32 V		92	0,01	1,0	

All ratings measured at 125 V, ambient temperature 25 °C +/- 3 °C / Alle Werte gemessen bei 125 V, Umgebungstemperatur 25 °C +/- 3 °C  
AC with unity power factor. DC with time constant less than 1 msec. / AC mit Einheits cos w. DC mit einer Zeitkonstanten < 1 msec.

**Universal modular fuse-links with wire leads Type FRT 250 F**

**quick-acting F**  
low breaking capacity  
directly solderable into printed circuit boards or plugable into fuseholders

**NEW**

**Universelle Kleinst-Sicherungseinsätze mit Drahtanschlüssen Typ FRT 250 F**

**flick F**  
kleines Schaltvermögen  
direkt einlötlbar in Leiterplatten oder steckbar in Sicherungshalter

**NEU**

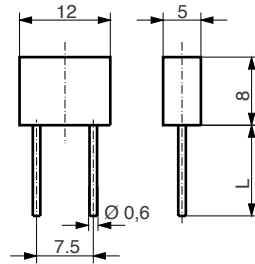
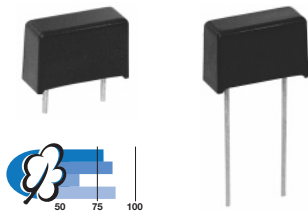

L: 3,5 (short / kurz)  
or / oder  
19 (long / lang)

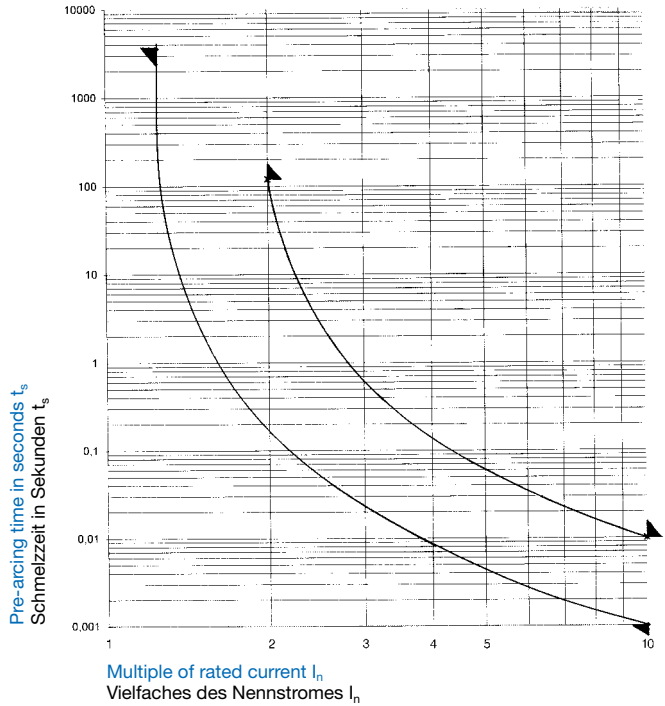

**Standards / Normen**

IEC 60127-4/1; EN 60127-4/1

**Approvals / Approbationen**

pending / angemeldet

**Pre-arcing time/current characteristic (at T<sub>a</sub> 23 °C)**

**Zeit-Strom-Charakteristik (bei T<sub>u</sub> 23 °C)**

Rated current I <sub>n</sub> / Nennstrom I <sub>n</sub>	1,25 · I <sub>n</sub> *		2 · I <sub>n</sub>		10 · I <sub>n</sub>	
	min.	max.	min.	max.	min.	max.
250 mA–6,3 A	60 min.	120 s	1 ms	10 ms		

\* Non fusing current I<sub>nf</sub> / Kleiner Prüfstrom I<sub>nf</sub>

Order No. / Bestell-Nr.	Terminals / Anschlüsse		Taped and reeled / gegürtet auf Rollen	Rated current I <sub>n</sub> / Rated voltage U <sub>n</sub> / Nennstrom I <sub>n</sub> / Nennspannung U <sub>n</sub>	Breaking capacity / Ausschaltvermögen	Voltage drop / Spannungsfall at / bei I <sub>n</sub>		Sustained power dissipation / Verlustleistung at / bei 1,25 I <sub>n</sub>		Pre-arcing I <sub>t</sub> / Schmelz I <sub>t</sub> at / bei 10 · I <sub>n</sub>	Approvals / Approbationen
	short / kurz	long / lang				max. IEC 60127 mV	typ. IEC 60127 mV	max. IEC 60127 mW	typ. IEC 60127 mW		
7100.1059.XX		7100.1159.XX	7100.1159.XX	250 mA / 250 V	100 A/250 V p.f. / cos w 0.95	800	460	500	300	1,9 · 10 <sup>-2</sup>	
7100.1060.XX		7100.1160.XX	7100.1160.XX	315 mA / 250 V		750	160	500	150	2,8 · 10 <sup>-2</sup>	
7100.1061.XX		7100.1161.XX	7100.1161.XX	400 mA / 250 V		700	140	500	150	4 · 10 <sup>-2</sup>	
7100.1062.XX		7100.1162.XX	7100.1162.XX	500 mA / 250 V		600	125	500	200	6 · 10 <sup>-2</sup>	
7100.1063.XX		7100.1163.XX	7100.1163.XX	630 mA / 250 V		500	180	500	250	7,5 · 10 <sup>-2</sup>	
7100.1064.XX		7100.1164.XX	7100.1164.XX	800 mA / 250 V		400	170	500	300	1,35 · 10 <sup>-1</sup>	
7100.1065.XX		7100.1165.XX	7100.1165.XX	1 A / 250 V		300	160	500	300	2 · 10 <sup>-1</sup>	
7100.1066.XX		7100.1166.XX	7100.1166.XX	1,25 A / 250 V		300	140	1000	300	3,2 · 10 <sup>-1</sup>	
7100.1067.XX		7100.1167.XX	7100.1167.XX	1,6 A / 250 V		300	140	1000	400	6 · 10 <sup>-1</sup>	
7100.1068.XX		7100.1168.XX	7100.1168.XX	2 A / 250 V		300	130	1000	500	1,1	
7100.1069.XX		7100.1169.XX	7100.1169.XX	2,5 A / 250 V		300	125	1000	500	1,9	
7100.1070.XX		7100.1170.XX	7100.1170.XX	3,15 A / 250 V		300	120	1200	650	3,3	
7100.1071.XX		7100.1171.XX	7100.1171.XX	4 A / 250 V		300	120	1500	900	5,9	
7100.1072.XX		7100.1172.XX	7100.1172.XX	5 A / 250 V		300	125	1875	1200	11	
7100.1073.XX		7100.1173.XX	7100.1173.XX	6,3 A / 250 V		300	130	–	1600	18	

.XX Packaging index / Verpackungsindex

Additional technical data and packaging see page 80 / Zusätzliche technische Daten und Verpackung siehe Seite 80

Suitable fuseholder see page 192 / Passender Sicherungshalter siehe Seite 192



FUSES / SICHERUNGEN

NON RESETTABLE / NICHT RÜCKSTELLEND

**NEW**

**Universal modular fuse-links with wire leads Type FRT 250 T time-lag T low breaking capacity directly solderable into printed circuit boards or plugable into fuseholders**

**NEU**

**Universelle Kleinst-Sicherungseinsätze mit Drahtanschlüssen Typ FRT 250 T träge T kleines Schaltvermögen direkt einlötlbar in Leiterplatten oder steckbar in Sicherungshalter**

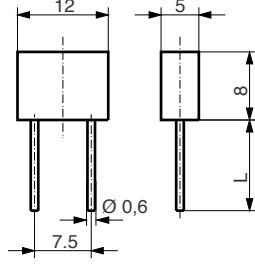
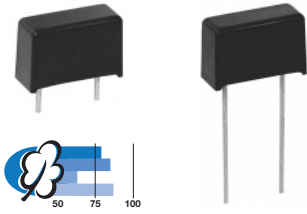

L: 3,5 (short / kurz) or / oder 19 (long / lang)

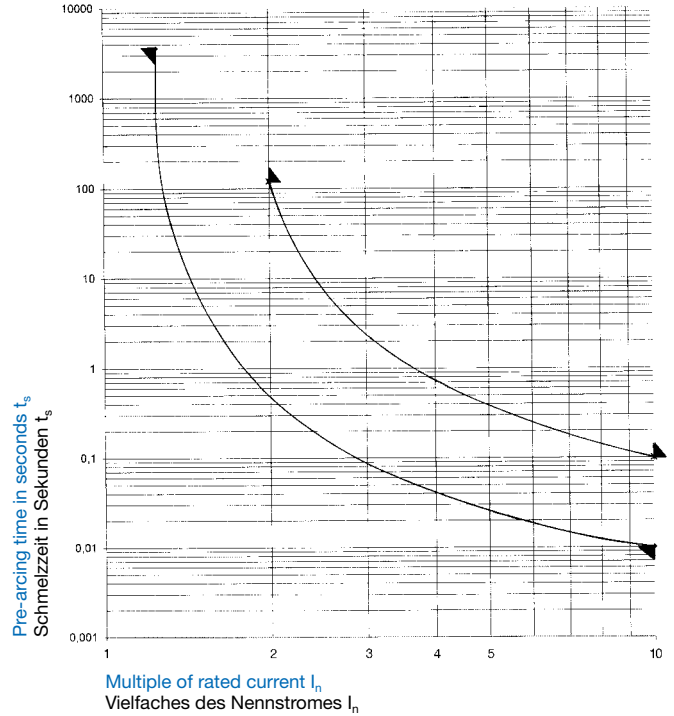

**Standards / Normen**

IEC 60127-4/1; EN 60127-4/1

**Approvals / Approbationen**



pending / angemeldet

**Pre-arcing time/current characteristic (at T<sub>a</sub> 23 °C)**

**Zeit-Strom-Charakteristik (bei T<sub>u</sub> 23 °C)**

n · I <sub>n</sub> Rated current I <sub>n</sub> / Nennstrom I <sub>n</sub>	1,25 · I <sub>n</sub> *		10 · I <sub>n</sub>	
	min.	max.	min.	max.
250 mA–6,3 A	60 min.	120 s	10 ms	100 ms

\* Non fusing current I<sub>nf</sub> / Kleiner Prüfstrom I<sub>nf</sub>

Order No. / Bestell-Nr.	Terminals / Anschlüsse		Taped and reeled / gegurtert auf Rollen	Rated current I <sub>n</sub> / Rated voltage U <sub>n</sub> / Nennstrom I <sub>n</sub> / Nennspannung U <sub>n</sub>	Breaking capacity / Ausschaltvermögen	Voltage drop / Spannungsfall at / bei I <sub>n</sub>		Sustained power dissipation / Verlustleistung at / bei 1,25 I <sub>n</sub>		Pre-arcing I <sup>2</sup> t / Schmelz I <sup>2</sup> t at / bei 10 · I <sub>n</sub> typ. A <sup>2</sup> s	Approvals / Approbationen
	short / kurz	long / lang				max. IEC 60127 mV	typ.  mV	max. IEC 60127 mW	typ.  mW		
7100.1009.XX	7100.1109.XX	7100.1109.XX	250 mA / 250 V	100 A/250 V AC p.f. / cos w 0.95	800	170	500	150	3,2 · 10 <sup>-1</sup>		
7100.1010.XX	7100.1110.XX	7100.1110.XX	315 mA / 250 V		750	160	500	200	5 · 10 <sup>-1</sup>		
7100.1011.XX	7100.1111.XX	7100.1111.XX	400 mA / 250 V		700	135	500	200	8 · 10 <sup>-1</sup>		
7100.1012.XX	7100.1112.XX	7100.1112.XX	500 mA / 250 V		600	125	500	200	1,25		
7100.1013.XX	7100.1113.XX	7100.1113.XX	630 mA / 250 V		500	130	500	200	2		
7100.1014.XX	7100.1114.XX	7100.1114.XX	800 mA / 250 V		400	200	500	300	3,2		
7100.1015.XX	7100.1115.XX	7100.1115.XX	1 A / 250 V		300	180	500	400	5		
7100.1016.XX	7100.1116.XX	7100.1116.XX	1,25 A / 250 V		300	145	1000	400	7,9		
7100.1017.XX	7100.1117.XX	7100.1117.XX	1,6 A / 250 V		300	110	1000	400	12,8		
7100.1018.XX	7100.1118.XX	7100.1118.XX	2 A / 250 V		300	105	1000	400	20		
7100.1019.XX	7100.1119.XX	7100.1119.XX	2,5 A / 250 V		300	140	1000	700	32		
7100.1020.XX	7100.1120.XX	7100.1120.XX	3,15 A / 250 V		300	115	1200	700	50		
7100.1021.XX	7100.1121.XX	7100.1121.XX	4 A / 250 V		300	120	1500	900	80		
7100.1022.XX	7100.1122.XX	7100.1122.XX	5 A / 250 V		300	125	1875	1200	125		
7100.1023.XX	7100.1123.XX	7100.1123.XX	6,3 A / 250 V		300	120	–	1400	200		

.XX Packaging index / Verpackungsindex

Additional technical data and packaging see page 80 / Zusätzliche technische Daten und Verpackung siehe Seite 80

 Suitable fuseholder see page 192 / Passender Sicherungshalter siehe Seite 192

**Technical data and packaging**  
**Types FRT 250 F**  
**FRT 250 T**

**Technische Daten und Verpackung**  
**Typen FRT 250 F**  
**FRT 250 T**

**Additional technical data / Zusätzliche technische Daten**

Ambient temperature max. $T_a$ Zulässige Umgebungstemperatur $T_u$	- 40 °C to / bis + 85 °C
Capacity at different $T_a$ Belastbarkeit bei verschiedenen $T_u$	1 · $I_n$ up to max. / bis max. 40 °C 0,9 · $I_n$ up to max. / bis max. 85 °C
Resistance to vibration Vibrationsbeständigkeit	Frequency 10 ÷ 2000 Hz, cross-over frequency 60 Hz < 60 Hz constant amplitude of 1,5 mm > 60 Hz constant acceleration of 100 m/s <sup>2</sup> (10 g) according to IEC 60068-2-6, test Fc  Frequenzbereich 10 ÷ 2000 Hz, Übergangsfrequenz 60 Hz < 60 Hz konstante Amplitude von 1,5 mm > 60 Hz konstante Beschleunigung von 100 m/s <sup>2</sup> (10 g) nach IEC 60068-2-6, Test Fc
Resistance to shock Schockbeständigkeit	490 m/s <sup>2</sup> (50 g), 11 ms according to / nach IEC 60068-2-27
Climate category Klimakategorie	according to / nach DIN 40040
Solderability Lötbarkeit	235 °C / 2 sec. according to IEC 60068-2-20, test Ta 235 °C / 2 sec. nach IEC 60068-2-20, Test Ta
Soldering heat resistance Lötwärmebeständigkeit	260 °C / 10 sec. according to IEC 60068-2-20, test Tb 260 °C / 10 sec. nach IEC 60068-2-20, Test Tb
Materials Werkstoff	Socket and cap Sockel und Kappe  Terminals Anschlüsse
	temperature resistant plastic, UL 94V-0 temperaturbeständiger Kunststoff; UL 94V-0  Copper tin-plated Kupfer verzinkt

**Packaging / Verpackung**

Box or tape / Schachtel oder Gurt	Types / Typen FRT 250 F, FRT 250 T
Boxes of 100 pieces / lose geschüttet à 100 Stück	7100.XXXX.13
Taped and reeled 500 pieces / Blistergurt à 500 Stück auf Rolle	7100.XXXX.95
Taped and reeled 1000 pieces / Blistergurt à 1000 Stück auf Rolle	7100.XXXX.96

**Tape and reel / Gurt und Rolle**

according to IEC 60286-2 / gemäss IEC 60286-2

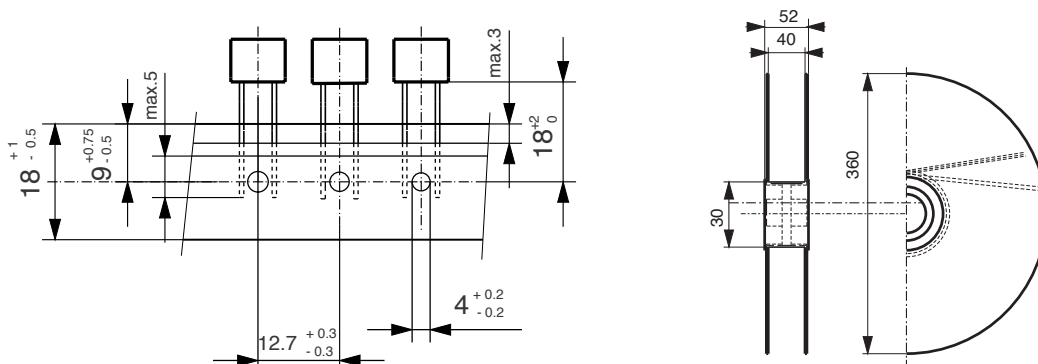

**FUSES / SICHERUNGEN**

**NON RESETTABLE / NICHT RÜCKSTELLEND**

**Fuse with signal contact and visual indicator**  
**Type PSC 125 V**  
**quick-acting F**

**Sicherung mit Signalkontakt und optischer Anzeige**  
**Typ PSC 125 V**  
**flink F**

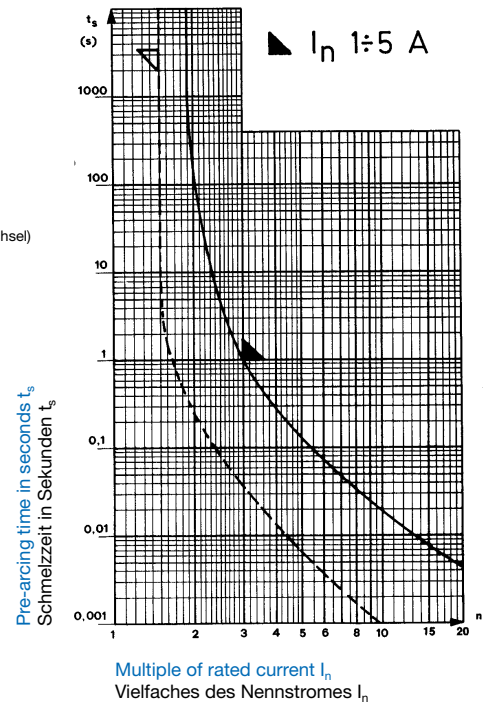
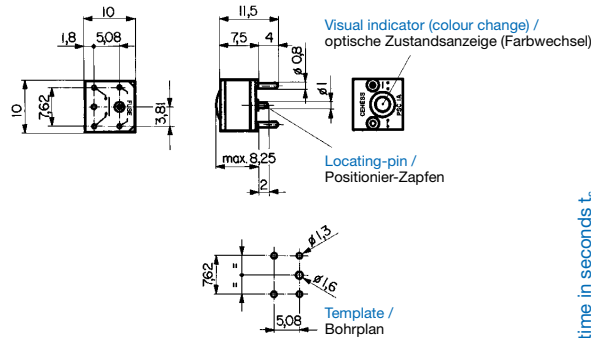
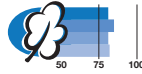

**Standards / Normen**

none / keine

**Approvals / Approbationen**



**Pre-arcing time/current characteristic (at T<sub>a</sub> 23 °C)**

**Zeit-Strom-Charakteristik (bei T<sub>u</sub> 23 °C)**

Rated current I <sub>n</sub> / Nennstrom I <sub>n</sub>	n · I <sub>n</sub>	
	1,5 · I <sub>n</sub>	3 · I <sub>n</sub>
	min.	max.
1 ÷ 5 A	1 h	1 s

- **Hauptstromkreis** mit eingebautem Schmelzelement, das bei unzulässiger Stromstärke den Hauptstromkreis unterbricht.
- **Signalstromkreis** mit optischer Anzeige und integriertem Schaltkontakt, welcher nach dem Unterbrechen des Schmelzelementes den Signalstromkreis schliesst. Dabei ändert sich die Farbe der optischen Anzeige. Die rasche Lokalisierung der Fehlerquelle wird damit erleichtert.

**Characteristics**

PSC fuses protect equipment against current loads of inadmissible magnitude and duration. They contain two independent circuits and a visual indicator.

- **The main circuit** containing a fuse-link which interrupts the main circuit when the permissible current is exceeded.
- **The signal circuit** with visual indicator and integrated auxiliary contact. This contact closes the signal circuit following interruption of the fuse-link. This causes the colour of the indicator to change, thereby facilitating the rapid localization of the fault.

**Charakteristik**

Die Sicherung PSC schützt Geräte gegen Strombelastungen unzulässiger Stärke und Dauer. Sie enthält zwei unabhängige Stromkreise sowie eine optische Anzeige.

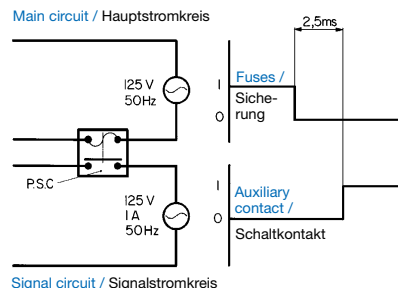

Order No. / Bestell-Nr.	Rated current I <sub>n</sub> / Nennstrom I <sub>n</sub> Rated voltage U <sub>n</sub> / Nennspannung U <sub>n</sub>		Breaking capacity / Ausschaltvermögen	Voltage drop / Spannungsfall at / bei I <sub>n</sub> max.	Approvals / Approbationen
	Main circuit / Hauptstromkreis	Signal circuit / Signalstromkreis			
7100.0160.71	1 A / 125 V AC/DC	1 A / 125 V AC/DC	UL: I <sub>n</sub> = 1 A ÷ 5 A: 50 A / 125 V AC/DC resistive / ohmsch I <sub>n</sub> ≤ 4 A: 80 A / 125 V AC p.f. 1 100 A / 125 V DC L/R = 1 ms I <sub>n</sub> ≤ 5 A: 200 A / 90 V AC p.f. 1 90 V DC L/R = 1 ms	mV	
7100.0170.71	2 A / 125 V AC/DC			100	
7100.0180.71	3 A / 125 V AC/DC			80	
7100.0190.71	4 A / 125 V AC/DC			70	
7100.0200.71	5 A / 125 V AC/DC			70	

**Additional technical data / Zusätzliche technische Daten**

Ambient temperature T <sub>a</sub> Zulässige Umgebungstemperatur T <sub>u</sub>	at I <sub>n</sub> : -40 °C to 70 °C / bei I <sub>n</sub> : -40 °C bis 70 °C at 0,8 · I <sub>n</sub> : + 125 °C / bei 0,8 · I <sub>n</sub> : bis + 125 °C
Resistance to vibration / Vibrationsbeständigkeit	10–2000 Hz / 10 g, according to / nach IEC 60068-2-6
Climatic category / Klimakategorie	55 / 125 / 56, according to / nach IEC 60068-1 / IEC 60068-2
Net weight / Nettogewicht %	2 g

**Packaging / Verpackung**

7100.XXXX.71 = Magazine holding 10 pieces / 10 Stück in Magazin



Suitable fuseholder see page 188 / Passender Sicherungshalter siehe Seite 188

## Fuse kits





with sub-miniature fuse-links

- with wire leads
- for surface mounting and with fuseholders

## Sicherungssortiments-Kasten

mit Kleinst-Sicherungseinsätzen

- mit Drahtanschlüssen
- für Oberflächenmontage und mit Sicherungshalter

Order No. / Bestell-Nr.	Content / Inhalt	Types / Typen	Pieces / Stück	Rated current $I_n$ Rated voltage $U_n$ / Nennstrom $I_n$ Nennspannung $U_n$	Characteristic / Charakteristik	Technical data see page / Technische Daten siehe Seite						
0034.9875	  with wire leads / mit Drahtanschlüssen  	Microfuses MSF 125	10	50 mA	125 V	quick-acting F / flink F	67					
			10	100 mA			67					
			10	125 mA			67					
			10	200 mA			67					
			10	250 mA			67					
			10	315 mA			67					
			10	400 mA			67					
			10	500 mA			67					
			10	630 mA			67					
			10	800 mA			67					
			10	1 A			67					
			10	1,25 A			67					
			10	1,6 A			67					
			10	2 A			67					
			10	3,15 A			67					
			10	4 A			67					
		10	5 A	67								
		Fuseholder / Si-Halter FMS	10	5 A		189						
0034.9876	  with wire leads / mit Drahtanschlüssen  	Microfuses MST 250	10	63 mA	250 V	time-lag T / träge T	69					
			10	80 mA			69					
			10	160 mA			69					
			10	315 mA			69					
			10	500 mA			69					
			10	1 A			69					
			10	1,25 A			69					
			10	2 A			69					
			10	3,15 A			69					
			10	5 A			69					
				Microfuses MSF 250	10	50 mA	250 V	quick-acting F / flink F	68			
					10	80 mA			68			
					10	315 mA			68			
					10	500 mA			68			
					10	1 A			68			
					10	2 A			68			
					10	3,15 A			68			
		10	5 A	68								
		Fuseholder / Si-Halter FMS	10	5 A		191						
0034.9877	  for surface mounting / für Oberflächenmontage	OMF 63 und OMF 125	je 5	100 mA	OMF 63: 63 V	quick-acting F / flink F	55, 56					
			je 5	250 mA			55, 56					
			je 5	630 mA			55, 56					
			je 5	1 A			55, 56					
			je 5	1,6 A			55, 56					
			je 5	2 A			55, 56					
			je 5	3,5 A			55, 56					
			je 5	5 A			55, 56					
							Fuseholder / Si-Halter OMH 125* OMF 250	10	5 A	OMF 125: 125 V	quick-acting F / flink F	193
								10	500 mA			250 V
				10	800 mA	57						
				10	1 A	57						
				10	1,25 A	57						
				10	1,6 A	57						
				10	2 A	57						
				10	3,15 A	57						
				10	4 A	57						

\* suitable for OMF 63 and OMF 125 / passend für OMF 63 und OMF 125

**FUSES / SICHERUNGEN**

**NON RESETTABLE / NICHT RÜCKSTELLEND**



**Fuse kits**

- with sub-miniature fuse-links
- with wire leads
  - for surface mounting and with fuseholders

**Sicherungssortiments-Kasten**

- mit Kleinst-Sicherungseinsätzen
- mit Drahtanschlüssen
  - für Oberflächenmontage und mit Sicherungshalter



Order No. / Bestell-Nr.	Content / Inhalt	Types / Typen	Pieces / Stück	Rated current I <sub>n</sub> Rated voltage U <sub>n</sub> / Nennstrom I <sub>n</sub> Nennspannung U <sub>n</sub>	Characteristic / Charakteristik	Breaking capacity / Ausschaltvermögen	Technical data see page / Technische Daten siehe Seite	
7189.0013		172876	50	125 mA	125 V	quick-acting F / flink F	300 A / 125 V	62
			50	250 mA				62
			50	375 mA				62
			50	500 mA				62
			50	750 mA				62
			50	1 A				62
			50	1,5 A				62
			50	2 A				62
			50	2,5 A				62
			50	3 A				62
			50	3,5 A				62
			50	4 A				62
			50	5 A				62
			50	7 A				62
			7189.0014					231786
231787	50							
7189.0014		172322	10	63 mA	125 V	quick-acting F / flink F	300 A / 125 V (300 A / 32 V)	72
			10	125 mA				72
			10	250 mA				72
			10	375 mA				72
			10	500 mA				72
			10	750 mA				72
			10	1 A				72
			10	1,5 A				72
			10	2 A				72
			10	2,5 mA				72
			10	3 mA				72
			10	3,5 mA				72
			10	4 mA				72
			10	5 A				72
			10	7 A				72
			10	10 A				72
			10	12 A				72
			10	15 A				32 V

**Miniature fuse-links  
Type DO**

quick-acting F  
low breaking capacity  
Glass tube

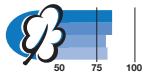

**G-Sicherungseinsätze  
Typ DO**

flick F  
kleines Ausschaltvermögen  
Glasrohr

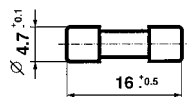

**Standards / Normen**

NF C 93-435 · Model HA35

**Approvals / Approbationen**

Lists / Listen: GAMT1, NNO

**Pre-arcing time/current  
characteristic (at T<sub>a</sub> 23 °C)**

**Zeit-Strom-Charakteristik  
(bei T<sub>u</sub> 23 °C)**

n · I <sub>n</sub>	1,1 · I <sub>n</sub>	1,7 · I <sub>n</sub>	3 · I <sub>n</sub>
Rated current I <sub>n</sub> / Nennstrom I <sub>n</sub>	min.	max.	max.
0,063 – 10 A	1 h	1 h	0,2 s

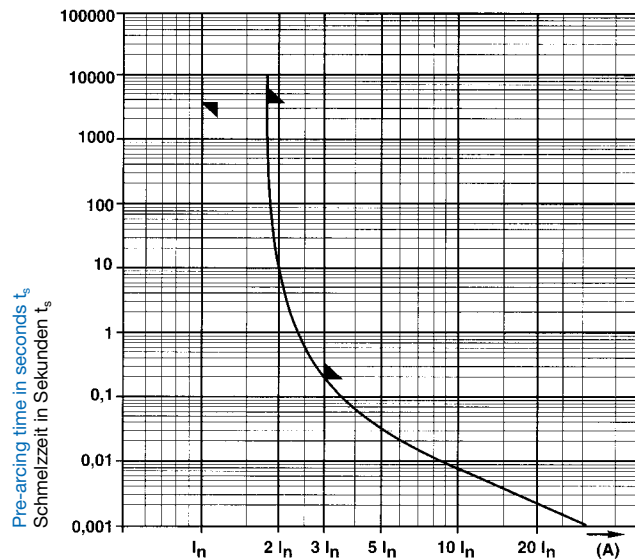

Multiple of rated current I<sub>n</sub>  
Vielfaches des Nennstromes I<sub>n</sub>

**Technical data**

Weight 1,1 g  
Climatic range 40 / 070 / 56 (564)  
Vibrations NF C 20-706 / IEC 60068-2-6  
Air 7306: 10-200 Hz  
1,5 mm / 10 g / 10 cycles

**Technische Daten**

Gewicht 1,1 g  
Klimakategorie 40 / 070 / 56 (564)  
Vibrationsbeständigkeit NF C 20-706 / IEC 60068-2-6  
Luft 7306: 10-200 Hz  
1,5 mm / 10 g / 10 Perioden

Order No. / Bestell-Nr.	Rated current I <sub>n</sub> / Rated voltage U <sub>n</sub> / Nennstrom I <sub>n</sub> / Nennspannung U <sub>n</sub>	Breaking capacity / Ausschaltvermögen	Voltage drop / Spannungsfall at / bei I <sub>n</sub> max.	Sustained power dissipation Verlustleistung at / bei 1,1 · I <sub>n</sub> max.	Pre-arcing I <sup>2</sup> t Schmelz I <sup>2</sup> t at / bei 10 · I <sub>n</sub>	Approvals / Approbationen
			mV	W	A <sup>2</sup> s	NNO GAMT1
7010.2110	0,063 A / 125 V	35 A / 125 V AC, p.f. / cos φ 0,9-1,0	1900	0,140	4,4 · 10 <sup>-4</sup>	•
7010.2120	0,080 A / 125 V		1400	0,150	1 · 10 <sup>-3</sup>	•
7010.2130	0,100 A / 125 V		1200	0,155	1,5 · 10 <sup>-3</sup>	• •
7010.2150	0,150 A / 125 V		960	0,190	6,7 · 10 <sup>-3</sup>	• •
7010.2170	0,200 A / 125 V		870	0,240	1,2 · 10 <sup>-2</sup>	• •
7010.2180	0,250 A / 125 V		795	0,270	2,5 · 10 <sup>-2</sup>	• •
7010.2190	0,310 A / 125 V		825	0,360	3,6 · 10 <sup>-2</sup>	• •
7010.2210	0,400 A / 125 V		1950	0,950	3 · 10 <sup>-2</sup>	• •
7010.2220	0,500 A / 125 V		1500	0,905	7,9 · 10 <sup>-2</sup>	• •
7010.2230	0,630 A / 125 V		2200	1,650	9,2 · 10 <sup>-2</sup>	• •
7010.2240	0,750 A / 125 V		1700	1,550	1,3 · 10 <sup>-1</sup>	• •
7010.2260	1 A / 125 V		275	0,385	2 · 10 <sup>-1</sup>	• •
7010.2410	1,50 A / 125 V		270	0,560	6,3 · 10 <sup>-1</sup>	• •
7010.2430	2 A / 125 V		175	0,470	1,2	• •
7010.2440	2,5 A / 125 V		155	0,515	3,4	• •
7010.2450	3 A / 125 V		155	0,610	4,8	• •
7010.2470	4 A / 125 V		210	1,160	7,8	• •
7010.2480	5 A / 125 V		145	0,935	14	• •
7010.2610	6,30 A / 125 V		130	1,040	31	•
7010.2620	8 A / 125 V		100	1,060	68	•
7010.2630	10 A / 125 V	120	1,480	110	•	

**Miniature fuse-links  
Type FSF 5 x 20**

 quick-acting F  
 low breaking capacity L  
 Glass tube

**G-Sicherungseinsätze  
Typ FSF 5 x 20**

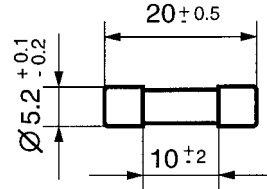
 flink F  
 kleines Ausschaltvermögen L  
 Glasrohr

**Standards / Normen**

IEC 60127-2/2, EN 60127-2/2.

**Approvals / Approbationen**

**Pre-arcing time/current  
characteristic (at T<sub>a</sub> 23 °C)**
**Zeit-Strom-Charakteristik  
(bei T<sub>u</sub> 23 °C)**

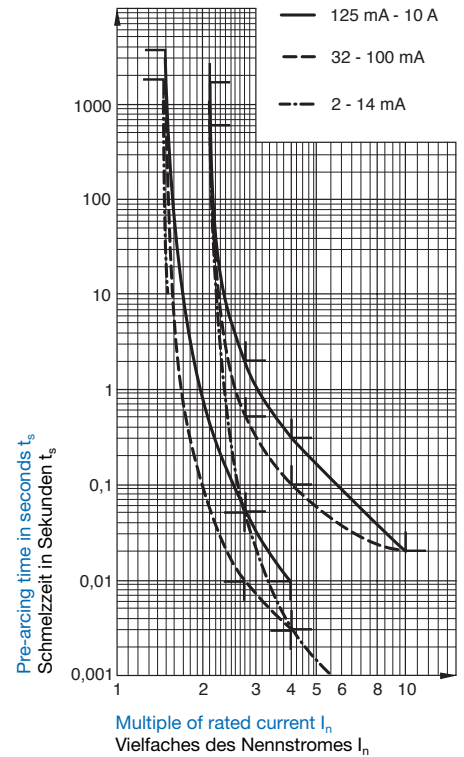
n · I <sub>n</sub> Rated current I <sub>n</sub> / Nennstrom I <sub>n</sub>	1,5 · I <sub>n</sub> *		2,1 · I <sub>n</sub>		2,75 · I <sub>n</sub>		4 · I <sub>n</sub>		10 · I <sub>n</sub>	
	min.	max.	min.	max.	min.	max.	min.	max.	min.	max.
2-14 mA AC/DC AC DC	30 min	10 min		50 ms 10 min		3 ms		0,3 ms		
32 – 100 mA	60 min	30 min	10 ms	500 ms	3 ms	100 ms		20 ms		
125 mA – 10A	60 min	30 min	50 ms	2 s	10 ms	300 ms		20 ms		

 \* Non fusing current I<sub>nf</sub> / Kleiner Prüfstrom I<sub>nf</sub>

Order No. / Bestell-Nr.	Rated current I <sub>n</sub> / Nennstrom I <sub>n</sub> Rated voltage U <sub>n</sub> / Nennspannung U <sub>n</sub>		Breaking capacity / Ausschaltvermögen	Voltage drop / Spannungsfall at / bei I <sub>n</sub> max. IEC 60127 mV		Sustained power dissipation / Verlustleistung at / bei 1,5 I <sub>n</sub> max. IEC 60127 W		Pre-arcing t <sup>st</sup> / Schmelzzeit at / bei 10 · I <sub>n</sub> typ. A <sup>2</sup> s	Approvals / Approbationen						
	typ.	max.		typ.	max.	typ.	max.		SEV	VDE	SEMKO	UL	CSA		
0034.1501	2	mA* / 250 V	L = 35 A / 250 V AC, p.f. / cos φ 1		1600		0,01	2 · 10 <sup>-8</sup>							
0034.1502	4	mA* / 250 V			540		0,01	1 · 10 <sup>-7</sup>							
0034.1503	7	mA* / 250 V			640		0,01	3,4 · 10 <sup>-7</sup>							
0034.1504	10	mA* / 250 V			500		0,01	7,1 · 10 <sup>-7</sup>							
0034.1505	14	mA* / 250 V			380		0,01	2,2 · 10 <sup>-6</sup>							
0034.1527	32	mA / 250 V			10000	9300	1,6	0,7	8,2 · 10 <sup>-5</sup>	•	•	•	•	•	•
0034.1528	40	mA / 250 V			8000	7400	1,6	0,7	1,28 · 10 <sup>-4</sup>	•	•	•	•	•	•
0034.1529	50	mA / 250 V			7000	6400	1,6	0,7	2,5 · 10 <sup>-4</sup>	•	•	•	•	•	•
0034.1530	63	mA / 250 V			5000	940	1,6	0,3	2,78 · 10 <sup>-4</sup>	•	•	•	•	•	•
0034.1531	80	mA / 250 V			4000	750	1,6	0,3	1,02 · 10 <sup>-3</sup>	•	•	•	•	•	•
0034.1506	100	mA / 250 V			3500	840	1,6	0,4	1,4 · 10 <sup>-3</sup>	•	•	•	•	•	•
0034.1507	125	mA / 250 V			2000	610	1,6	0,4	4,84 · 10 <sup>-3</sup>	•	•	•	•	•	•
0034.1508	160	mA / 250 V			2000	550	1,6	0,5	1,13 · 10 <sup>-2</sup>	•	•	•	•	•	•
0034.1509	200	mA / 250 V			1700	540	1,6	0,5	2,52 · 10 <sup>-2</sup>	•	•	•	•	•	•
0034.1510	250	mA / 250 V			1400	240	1,6	0,2	1,59 · 10 <sup>-2</sup>	•	•	•	•	•	•
0034.1511	315	mA / 250 V			1300	210	1,6	0,2	3,67 · 10 <sup>-2</sup>	•	•	•	•	•	•
0034.1512	400	mA / 250 V			1200	200	1,6	0,2	8,5 · 10 <sup>-2</sup>	•	•	•	•	•	•
0034.1513	500	mA / 250 V			1000	150	1,6	0,2	1,51 · 10 <sup>-1</sup>	•	•	•	•	•	•
0034.1514	630	mA / 250 V			650	140	1,6	0,3	3,03 · 10 <sup>-1</sup>	•	•	•	•	•	•
0034.1515	800	mA / 250 V		240	110	1,6	0,3	5,08 · 10 <sup>-1</sup>	•	•	•	•	•	•	
0034.1516	1	A / 250 V		200	110	1,6	0,3	1,13	•	•	•	•	•	•	
0034.1517	1,25	A / 250 V		200	100	1,6	0,4	1,81	•	•	•	•	•	•	
0034.1518	1,6	A / 250 V		190	100	1,6	0,5	2,94	•	•	•	•	•	•	
0034.1519	2	A / 250 V		170	90	1,6	0,6	5,28	•	•	•	•	•	•	
0034.1520	2,5	A / 250 V		170	90	1,6	0,8	9,19	•	•	•	•	•	•	
0034.1521	3,15	A / 250 V		150	90	2,5	0,6	16,1	•	•	•	•	•	•	
0034.1522	4	A / 250 V		130	90	2,5	1,0	25,6	•	•	•	•	•	•	
0034.1523	5	A / 250 V	L = 10 I <sub>n</sub> / 250 V AC, p.f. / cos φ 1	130	80	2,5	1,3	33,8	•	•	•	•	•	•	
0034.1524	6,3	A / 250 V		130	80	2,5	2,0	53,2	•	•	•	•	•	•	
0034.1525	8	A* / 250 V			80		2,3	93,4	•	•	•	•	•	•	
0034.1526	10	A* / 250 V			70		2,5	183	•	•	•	•	•	•	

\* Not mentioned in the standards

\*In den Normen nicht enthalten

 Available as Pigtail miniature fuse-links, see page 97 /  
 Auch als G-Sicherungseinsätze mit Drahtanschlüssen lieferbar, siehe Seite 97

**Miniature fuse-links  
Type FST 5 x 20**

**time-lag T**  
low breaking capacity L  
Glass tube



**G-Sicherungseinsätze  
Typ FST 5 x 20**

**träge T**  
kleines Ausschaltvermögen L  
Glasrohr

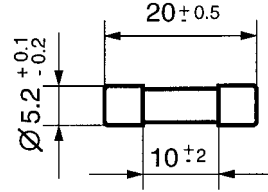

**Standards / Normen**

IEC 60127-2/3, EN 60127-2/3.

**Approvals / Approbationen**

- SEV
- VDE
- SEMKO
- BSI
- UL
- CSA
- CB-Certificate

**Pre-arcing time/current  
characteristic (at T<sub>a</sub> 23 °C)**

**Zeit-Strom-Charakteristik  
(bei T<sub>u</sub> 23 °C)**

n · I <sub>n</sub> Rated current I <sub>n</sub> / Nennstrom I <sub>n</sub>	1,5 · I <sub>n</sub> *		2,1 · I <sub>n</sub>		2,75 · I <sub>n</sub>		4 · I <sub>n</sub>		10 · I <sub>n</sub>	
	min.	max.	min.	max.	min.	max.	min.	max.	min.	max.
20 – 100 mA	60 min	2 min**	200 ms**	10 s**	40 ms	3 s	10 ms	300 ms		
125 mA – 20 A	60 min	2 min	600 ms	10 s	150 ms	3 s	20 ms	300 ms		

\* Non fusing current I<sub>nf</sub> / Kleiner Prüfstrom I<sub>nf</sub>

\*\* These values are not guaranteed at 20 mA / Diese Werte werden bei 20 mA nicht garantiert

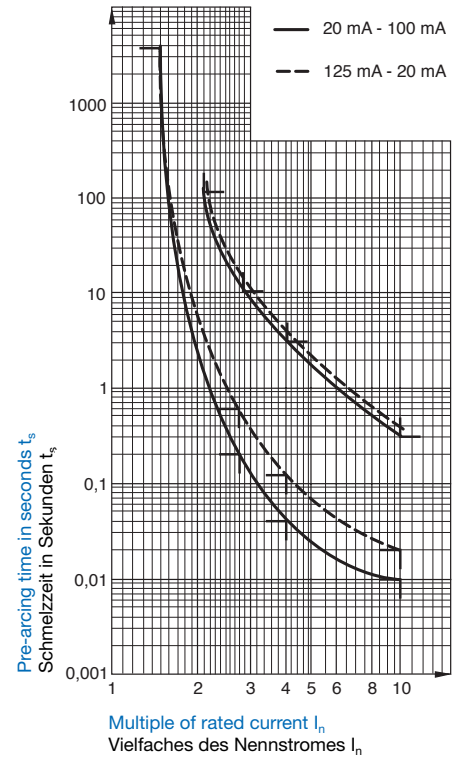

Order No. / Bestell-Nr.	Rated current I <sub>n</sub> / Nennstrom I <sub>n</sub> Rated voltage U <sub>n</sub> / Nennspannung U <sub>n</sub>	Breaking capacity / Ausschaltvermögen	Voltage drop / Spannungsfall at / bei I <sub>n</sub> max. IEC 60127 mV		Sustained power dissipation / Verlustleistung at / bei 1,5 I <sub>n</sub> max. IEC 60127 W		Pre-arcing I <sup>2</sup> t / Schmelz I <sup>2</sup> t at / bei 10 · I <sub>n</sub> typ. A <sup>2</sup> s	Approvals / Approbationen SEV VDE SEMKO BSI UL CSA CB
			typ. □	max. □	typ. □	max. □		
0034.3101	20 mA* / 250 V	L = 35 A / 250 V AC, p.f. / cos φ 1		2700		0,1	1,2 · 10 <sup>-3</sup>	
0034.3102	32 mA / 250 V		5000	3000	1,6	0,2	1,9 · 10 <sup>-3</sup>	• • • • •
0034.3103	40 mA / 250 V		4000	2100	1,6	0,2	2,7 · 10 <sup>-3</sup>	• • • • •
0034.3104	50 mA / 250 V		3500	950	1,6	0,125	3,63 · 10 <sup>-2</sup>	• • • • •
0034.3105	63 mA / 250 V		3000	1300	1,6	0,2	4,01 · 10 <sup>-2</sup>	• • • • •
0034.3106	80 mA / 250 V		3000	1100	1,6	0,3	5,70 · 10 <sup>-2</sup>	• • • • •
0034.3107	100 mA / 250 V		2500	1000	1,6	0,3	1,07 · 10 <sup>-1</sup>	• • • • •
0034.3108	125 mA / 250 V		2000	400	1,6	0,2	6,4 · 10 <sup>-2</sup>	• • • • •
0034.3109	160 mA / 250 V		1900	340	1,6	0,2	2,3 · 10 <sup>-1</sup>	• • • • •
0034.3110	200 mA / 250 V		1500	270	1,6	0,2	2,56 · 10 <sup>-1</sup>	• • • • •
0034.3111	250 mA / 250 V		1300	210	1,6	0,2	2,38 · 10 <sup>-1</sup>	• • • • •
0034.3112	315 mA / 250 V		1100	170	1,6	0,2	5,44 · 10 <sup>-1</sup>	• • • • •
0034.3113	400 mA / 250 V		1000	150	1,6	0,2	7,68 · 10 <sup>-1</sup>	• • • • •
0034.3114	500 mA / 250 V		900	160	1,6	0,2	3	• • • • •
0034.3115	630 mA / 250 V		300	160	1,6	0,3	4,35	• • • • •
0034.3116	800 mA / 250 V		250	120	1,6	0,3	3,85	• • • • •
0034.3117	1 A / 250 V		150	60	1,6	0,2	3,30	• • • • •
0034.3118	1,25 A / 250 V		150	60	1,6	0,3	5,50	• • • • •
0034.3165	1,4 A* / 250 V			60		0,3	7,45	•
0034.3119	1,6 A / 250 V			150	60	1,6	0,3	10,5
0034.3120	2 A / 250 V		150	60	1,6	0,3	16	• • • • •
0034.3121	2,5 A / 250 V		120	60	1,6	0,4	21,9	• • • • •
0034.3122	3,15 A / 250 V		100	60	1,6	0,5	47	• • • • •
0034.3123	4 A / 250 V	L = 10 I <sub>n</sub> / 250 V AC, p.f. / cos φ 1	100	60	1,6	0,8	68,3	• • • • •
0034.3124	5 A / 250 V		100	60	1,6	0,9	102	• • • • •
0034.3125	6,3 A / 250 V		100	60	1,6	1,0	190	• • • • •
0034.3126	8 A / 250 V*			60		1,3	275	• •
0034.3127	10 A / 250 V*			60		1,3	520	• •
0034.3128	12,5 A / 250 V*			60		2,5	750	• •
0034.3129	16 A / 250 V*			60		3,3	1638	• •
0034.3130	20 A / 250 V*			60		4,2	3057	• •

\* Not mentioned in the standards

\*In den Normen nicht enthalten



Available as Pigtail miniature fuse-links, see page 97 /  
Auch als G-Sicherungseinsätze mit Drahtanschlüssen lieferbar, siehe Seite 97

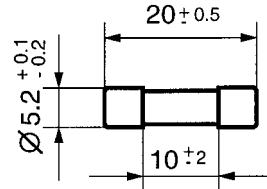

**Miniature fuse-links  
Type FSM 5 x 20**
**medium-time-lag M**  
 low and medium  
 breaking capacity  
 Glass tube

**G-Sicherungseinsätze  
Typ FSM 5 x 20**
**mittelträge M**  
 kleines und mittelgrosses  
 Ausschaltvermögen  
 Glasrohr

**Standards / Normen**

DIN 41571, data sheet 2 / Blatt 2

**Approvals / Approbationen**

none / keine

**Pre-arcing time/current  
characteristic (at T<sub>a</sub> 23 °C)**
**Zeit-Strom-Charakteristik  
(bei T<sub>u</sub> 23 °C)**

Rated current I <sub>n</sub> / Nennstrom I <sub>n</sub>	n · I <sub>n</sub>		4 · I <sub>n</sub>		10 · I <sub>n</sub>	
	min.	max.	min.	max.	min.	max.
0,315 – 1,25 A	60 min	10 min	40 ms	2 s	5 ms	90 ms
1,6 – 10 A	60 min	30 min	40 ms	2 s	5 ms	90 ms

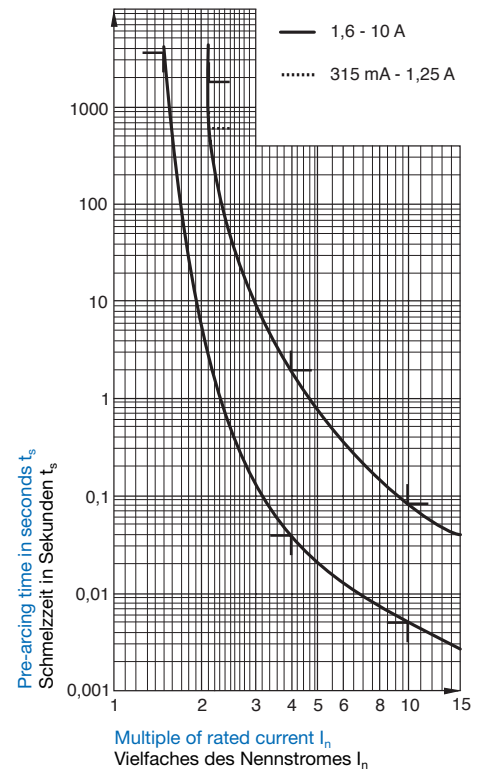
 \* Non fusing current I<sub>nf</sub> / Kleiner Prüfstrom I<sub>nf</sub>

Order No. / Bestell-Nr.	Rated current I <sub>n</sub> / Rated voltage U <sub>n</sub> / Nennstrom I <sub>n</sub> / Nennspannung U <sub>n</sub>	Breaking capacity / Ausschaltvermögen	Voltage drop / Spannungsfall at / bei I <sub>n</sub>		Sustained power dissipation / Verlustleistung at / bei 1,5 I <sub>n</sub>	Pre-arcing I <sup>2</sup> t / Schmelz I <sup>2</sup> t at / bei 10 · I <sub>n</sub>	
			max. mV	typ. mV			typ. W
0034.2511	315 mA / 250 V	80 A 125 V DC	C	250	200	0,2	2,68 · 10 <sup>-1</sup>
0034.2512	400 mA / 250 V		C	230	160	0,2	6,32 · 10 <sup>-1</sup>
0034.2513	500 mA / 250 V		C	210	140	0,2	6,75 · 10 <sup>-1</sup>
0034.2514	630 mA / 250 V	80 A 250 V AC p.f. / cos φ 1	C	190	140	0,2	9,05 · 10 <sup>-1</sup>
0034.2515	800 mA / 250 V		C	170	130	0,2	1,68
0034.2516	1 A / 250 V		C	160	70	0,2	3,6
0034.2517	1,25 A / 250 V	1000 A 125 V DC	C	160	70	0,2	5,47
0034.2518	1,6 A / 250 V		E	160	150	0,6	3,33
0034.2519	2 A / 250 V		E	160	140	0,7	4,8
0034.2520	2,5 A / 250 V	1000 A 250 V AC p.f. / cos φ 1	E	160	130	0,8	10,9
0034.2521	3,15 A / 250 V		E	160	120	1,0	20,4
0034.2522	4 A / 250 V		E	160	120	1,3	35,2
0034.2523	5 A / 250 V	300 A 125 V DC	E	150	100	1,4	52,5
0034.2524	6,3 A / 250 V		E	140	100	1,7	159
0034.2525	8 A / 250 V		D	140	90	2,3	237
0034.2526	10 A / 250 V	D	120	80	2,3	430	
		300 A 250 V AC p.f. / cos φ 1					

**Miniature fuse-links  
Type FTT 5 x 20**

super-time-lag TT  
low breaking capacity  
Glass tube

**G-Sicherungseinsätze  
Typ FTT 5 x 20**

superträge TT  
kleines Ausschaltvermögen  
Glasrohr

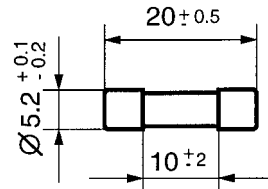

**Standards / Normen**

UL 248-14 (formerly / früher 198.G)

**Approvals / Approbationen**



**Pre-arcing time/current  
characteristic (at T<sub>a</sub> 23 °C)**

**Zeit-Strom-Charakteristik  
(bei T<sub>u</sub> 23 °C)**

n · I <sub>n</sub> Rated current I <sub>n</sub> / Nennstrom I <sub>n</sub>	1,5 · I <sub>n</sub> *		2,1 · I <sub>n</sub>		2,75 · I <sub>n</sub>		4 · I <sub>n</sub>		10 · I <sub>n</sub>	
	min.	max.	min.	max.	min.	max.	min.	max.	min.	max.
63 – 100 mA	60 min	30 min	3 s	100 s	800 ms	20 s	0,06 s	1 s		
125 mA – 4 A	60 min	30 min	5 s	200 s	1,5 s	40 s	0,15 s	3 s		

\* Non fusing current I<sub>nf</sub> / Kleiner Prüfstrom I<sub>nf</sub>

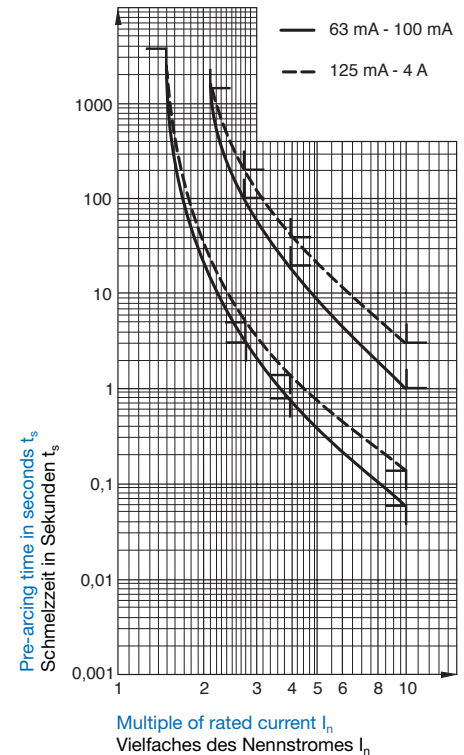

Order No. / Bestell-Nr.	Rated current I <sub>n</sub> / Rated voltage U <sub>n</sub> / Nennstrom I <sub>n</sub> / Nennspannung U <sub>n</sub>	Breaking capacity / Ausschaltvermögen	Voltage drop / Spannungsfall at / bei I <sub>n</sub>		Sustained power dissipation / Verlustleistung at / bei 1,5 I <sub>n</sub>	Pre-arcing I <sup>2</sup> t / Schmelz I <sup>2</sup> t at / bei 10 · I <sub>n</sub>	Approvals / Approbationen
			max. mV	typ. mV			
0034.5001	63 mA / 250 V	35 A / 250 V AC, p.f. / cos φ 1	5000	1000	0,22	3,7 · 10 <sup>-2</sup>	UL
0034.5002	80 mA / 250 V		4500	980	0,27	3,2 · 10 <sup>-2</sup>	•
0034.5003	100 mA / 250 V		4000	870	0,30	1,4 · 10 <sup>-1</sup>	•
0034.5004	125 mA / 250 V		3000	500	0,27	2,59 · 10 <sup>-1</sup>	•
0034.5035	160 mA / 250 V		2000	450	0,30	1,0	•
0034.5036	200 mA / 250 V		1500	400	0,33	1,73	•
0034.5037	250 mA / 250 V		1200	330	0,35	2,53	•
0034.5038	315 mA / 250 V		1000	300	0,36	4,17	•
0034.5039	400 mA / 250 V		900	225	0,40	5,2	•
0034.5040	500 mA / 250 V		800	250	0,44	7,9	•
0034.5041	630 mA / 250 V		700	200	0,47	13,7	•
0034.5042	800 mA / 250 V		500	160	0,54	19,6	•
0034.5043	1 A / 250 V		250	150	0,54	19,4	•
0034.5044	1,25 A / 250 V		200	130	0,57	33,3	•
0034.5045	1,6 A / 250 V		200	100	0,65	87	•
0034.5046	2 A / 250 V		200	100	0,80	124	•
0034.5047	2,5 A / 250 V		150	90	0,85	258	•
0034.5048	3,15 A / 250 V		100	90	1,0	395	•
0034.5049	4 A / 250 V		100	80	1,15	410	•

**Miniature fuse-links  
Type FSQ 5 x 20**

 quick-acting F  
Glass tube

**G-Sicherungseinsätze  
Typ FSQ 5 x 20**

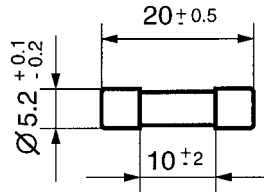
 flink F  
Glasrohr

**Standards / Normen**

 UL 248-14 (formerly / früher 198.G)  
 CSA C22.2 No. 248.14 (formerly / früher 59.2 M)

**Approvals / Approbationen**

**Pre-arcing time/current  
characteristic (at T<sub>a</sub> 23 °C)**
**Zeit-Strom-Charakteristik  
(bei T<sub>u</sub> 23 °C)**

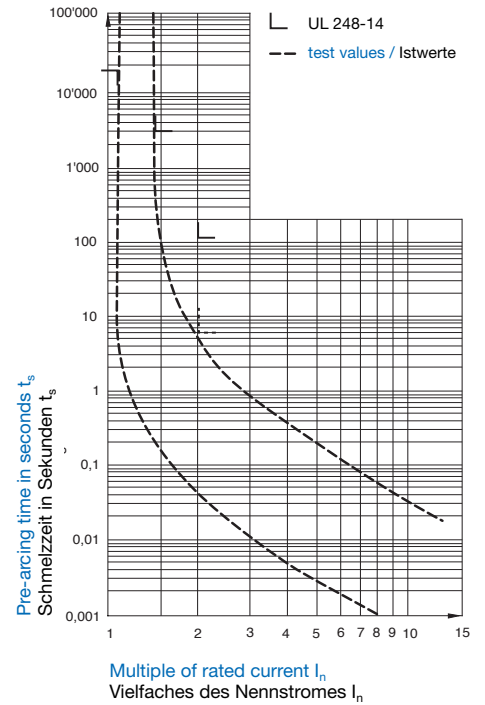
n · I <sub>n</sub> Rated current I <sub>n</sub> / Nennstrom I <sub>n</sub>	1,1 · I <sub>n</sub> *	1,35 · I <sub>n</sub>	2 · I <sub>n</sub>
	min.	max.	max.
400 mA–3,5A	4 h	1 h	120 s

 \* Non fusing current I<sub>nf</sub> / Kleiner Prüfstrom I<sub>nf</sub>

Order No. / Bestell-Nr.	Rated current I <sub>n</sub> / Rated voltage U <sub>n</sub> / Nennstrom I <sub>n</sub> / Nennspannung U <sub>n</sub>	Breaking capacity / Ausschaltvermögen	Voltage drop / Spannungsfall at / bei I <sub>n</sub>	Sustained power dissipation / Verlustleistung at / bei 1,1 I <sub>n</sub>	Pre-arcing I <sup>2</sup> t / Schmelz I <sup>2</sup> t at / bei 10 · I <sub>n</sub>	Approvals / Approbationen  UL CSA
			typ. mV	typ. W	typ. A <sup>2</sup> s	
0034.3951	400 mA / 250 V	10 000 A / 125 V AC, p.f. / cos φ 0,7-0,8	170	0,1	8,2 · 10 <sup>-1</sup>	• •
0034.3952	500 mA / 250 V		140	0,1	2,11 · 10 <sup>-1</sup>	• •
0034.3953	600 mA / 250 V		150	0,1	2,58 · 10 <sup>-1</sup>	• •
0034.3954	700 mA / 250 V	35 A / 250 V AC, p.f. / cos φ 0,7-0,8	150	0,2	4,17 · 10 <sup>-1</sup>	• •
0034.3955	750 mA / 250 V		150	0,2	6 · 10 <sup>-1</sup>	• •
0034.3956	800 mA / 250 V		140	0,2	6,62 · 10 <sup>-1</sup>	• •
0034.3957	1 A / 250 V	10 000 A / 125 V AC, p.f. / cos φ 0,7-0,8	120	0,2	1,15	• •
0034.3958	1,2 A / 250 V		110	0,2	1,82	• •
0034.3959	1,25 A / 250 V		110	0,2	1,84	• •
0034.3960	1,5 A / 250 V		110	0,3	3,11	• •
0034.3961	1,6 A / 250 V		110	0,3	3,84	• •
0034.3962	1,8 A / 250 V		100	0,3	4,07	• •
0034.3963	2 A / 250 V		100	0,3	4,51	• •
0034.3964	2,25 A / 250 V		100	0,3	6,77	• •
0034.3965	2,5 A / 250 V		100	0,4	11,1	• •
0034.3966	2,8 A / 250 V		100	0,5	12,7	• •
0034.3967	3 A / 250 V	100 A / 250 V AC, p.f. / cos φ 0,7-0,8	100	0,5	14,8	• •
0034.3968	3,2 A / 250 V		100	0,5	19,2	• •
0034.3969	3,5 A / 250 V		90	0,5	26,3	• •

**Miniature fuse-links**  
**Type FSD 5 x 20**

time delay  
Glass tube

**G-Sicherungseinsätze**  
**Typ FSD 5 x 20**

träge  
Glasrohr

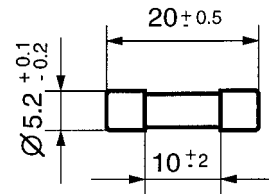

**Standards / Normen**

UL 248-14 (formerly / früher 198 G)  
CSA C22.2 No. 248.14 (formerly / früher 59.2 M)

**Approvals / Approbationen**



**Pre-arcing time/current characteristic (at T<sub>a</sub> 23 °C)**

**Zeit-Strom-Charakteristik (bei T<sub>u</sub> 23 °C)**

n · I <sub>n</sub> Rated current I <sub>n</sub> / Nennstrom I <sub>n</sub>	1,1 · I <sub>n</sub> *		2 · I <sub>n</sub>	
	min.	max.	min.	max.
100 mA – 3 A	4 h	1 h	5 s	120 s
3,2 – 3,5 A	4 h	1 h	12 s	120 s

\* Non fusing current I<sub>nf</sub> / Kleiner Prüfstrom I<sub>nf</sub>

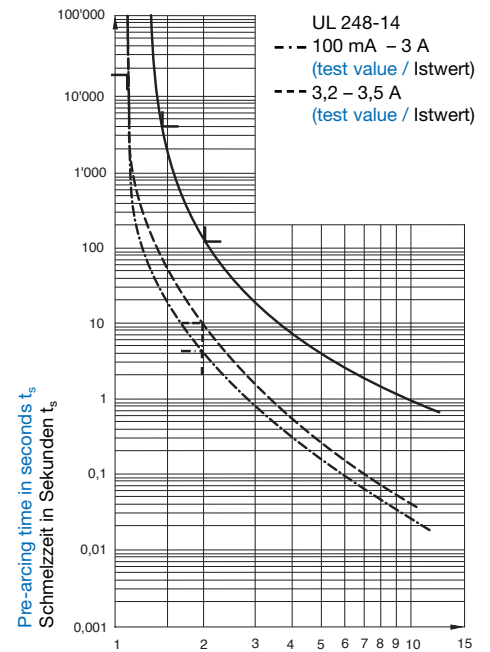

Multiple of rated current I<sub>n</sub>  
Vielfaches des Nennstromes I<sub>n</sub>

Order No. / Bestell-Nr.	Rated current I <sub>n</sub> / Rated voltage U <sub>n</sub> / Nennstrom I <sub>n</sub> / Nennspannung U <sub>n</sub>	Breaking capacity / Ausschaltvermögen	Voltage drop / Spannungsfall at / bei I <sub>n</sub>		Sustained power dissipation / Verlustleistung at / bei 1,1 I <sub>n</sub>	Pre-arcing I <sup>2</sup> t / Schmelz I <sup>2</sup> t at / bei 10 · I <sub>n</sub>	Approvals / Approbationen	
			max. mV	typ. mV				typ. W
0034.3972	100 mA / 250 V	10 000 A / 125 V AC, p.f. / cos φ 0,7-0,8		1550	0,16	4,4 · 10 <sup>-2</sup>	UL • CSA •	
0034.3973	125 mA / 250 V			1240	0,15	8,4 · 10 <sup>-2</sup>	• •	
0034.3974	150 mA / 250 V			1240	0,19	1,31 · 10 <sup>-1</sup>	• •	
0034.3975	175 mA / 250 V			1000	0,18	2,39 · 10 <sup>-1</sup>	• •	
0034.3976	187 mA / 250 V			910	0,17	3,35 · 10 <sup>-1</sup>	• •	
0034.3977	200 mA / 250 V			890	0,18	3,37 · 10 <sup>-1</sup>	• •	
0034.3978	250 mA / 250 V			770	0,19	4,86 · 10 <sup>-1</sup>	• •	
0034.3979	300 mA / 250 V			700	0,21	6,21 · 10 <sup>-1</sup>	• •	
0034.3980	375 mA / 250 V		35 A / 250 V AC, p.f. / cos φ 0,7-0,8		510	0,19	1,18	• •
0034.3981	400 mA / 250 V				540	0,21	3,5	• •
0034.3982	500 mA / 250 V				470	0,23	2	• •
0034.3983	600 mA / 250 V				380	0,23	6,19	• •
0034.3984	700 mA / 250 V				360	0,25	6,32	• •
0034.3985	750 mA / 250 V				270	0,21	7,99	• •
0034.3986	800 mA / 250 V				330	0,26	8,06	• •
0034.3987	1 A / 250 V				270	0,27	10,6	• •
0034.3988	1,2 A / 250 V			10 000 A / 125 V AC, p.f. / cos φ 0,7-0,8		240	0,30	18,9
0034.3989	1,25 A / 250 V				240	0,31	20,8	• •
0034.3990	1,5 A / 250 V		210		0,32	21,9	• •	
0034.3991	1,6 A / 250 V		200		0,32	30	• •	
0034.3992	1,8 A / 250 V		190		0,34	34,7	• •	
0034.3993	2 A / 250 V		180		0,37	56	• •	
0034.3994	2,25 A / 250 V	100 A / 250 V AC, p.f. / cos φ 0,7-0,8			225	1,2	86,1	• •
0034.3995	2,5 A / 250 V				215	1,2	108	• •
0034.3996	2,8 A / 250 V				210	1,2	157	• •
0034.3997	3 A / 250 V				200	1,3	156	• •
0034.3998	3,2 A / 250 V				200	1,3	165	• •
0034.3999	3,5 A / 250 V			200	1,3	245	• •	

**Miniature fuse-links  
Type SA 5 x 20**

 super-quick acting FF  
 high breaking capacity  
 Ceramic tube

**G-Sicherungseinsätze  
Typ SA 5 x 20**

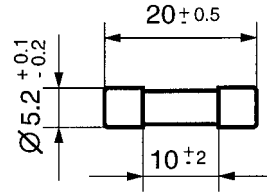
 superflink FF  
 grosses Ausschaltvermögen  
 Keramikrohr

**Standards / Normen**

SEMKO 104-1976

**Approvals / Approbationen**

SEMKO

**Pre-arcing time/current  
characteristic (at T<sub>a</sub> 23 °C)**
**Zeit-Strom-Charakteristik  
(bei T<sub>y</sub> 23 °C)**

n · I <sub>n</sub> Rated current I <sub>n</sub> / Nennstrom I <sub>n</sub>	1,2 · I <sub>n</sub> *		2 · I <sub>n</sub>		2,75 · I <sub>n</sub>		4 · I <sub>n</sub>		10 · I <sub>n</sub>
	min.	min. / max.	min. / max.	min. / max.	min. / max.	min. / max.	max.		
1,6 – 10 A	60 min	10 ms / 2 s	4 ms / 50 ms	2 ms / 15 ms	2 ms				

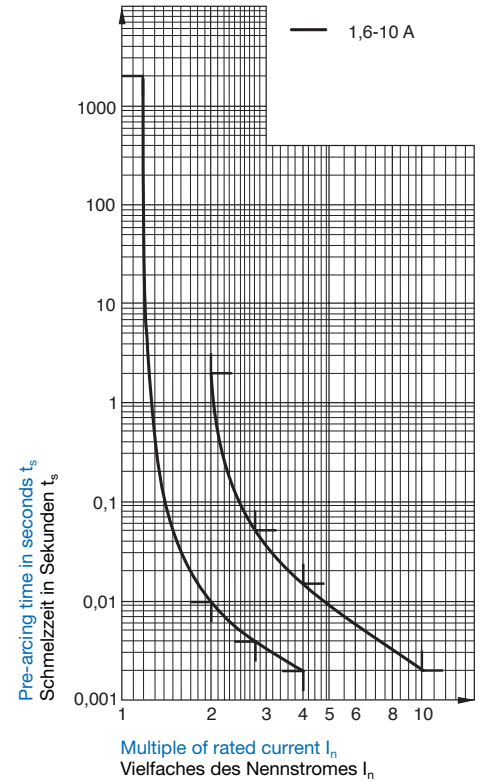
 \* Non fusing current I<sub>nf</sub> / Kleiner Prüfstrom I<sub>nf</sub>

Order No. / Bestell-Nr.	Rated current I <sub>n</sub> / Rated voltage U <sub>n</sub> / Nennstrom I <sub>n</sub> / Nennspannung U <sub>n</sub>	Breaking capacity / Ausschaltvermögen	Voltage drop / Spannungsfall at / bei I <sub>n</sub>		Sustained power dissipation / Verlustleistung at / bei 1,2 I <sub>n</sub>		Pre-arcing I <sup>2</sup> t / Schmelz I <sup>2</sup> t at / bei 10 · I <sub>n</sub>	Approvals / Approbationen  SEMKO
			max. mV	typ. mV	max. W	typ. W		
0034.0903	1,6 A / 250 V	1500 A at / bei 250 V AC, 50 Hz p.f. / cos φ 0,7–0,8	400	250	1,0	0,6	3,84 · 10 <sup>-1</sup>	•
0034.0904	2 A / 250 V		370	200	1,1	0,6	4,84 · 10 <sup>-1</sup>	•
0034.0905	2,5 A / 250 V		340	200	1,3	0,8	1,06	•
0034.0906	3,15 A / 250 V		310	180	1,5	1,0	1,26	•
0034.0907	4 A / 250 V		280	180	1,7	1,2	1,28	•
0034.0908	5 A / 250 V		250	160	1,9	1,4	1,78	•
0034.0909	6,3 A / 250 V		250	170	2,3	2,0	5,95	•
0034.0910	8 A / 250 V		250	190	3,0	2,8	8,32	
0034.0911	10 A / 250 V		250	160	3,7	2,9	17	

**Miniature fuse-links  
Type SP 5 x 20**

quick-acting F  
high breaking capacity H  
Ceramic tube



**G-Sicherungseinsätze  
Typ SP 5 x 20**

flink F  
grosses Ausschaltvermögen H  
Keramikrohr

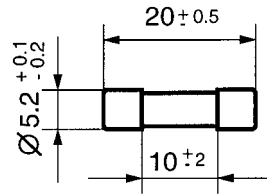

**Standards / Normen**

IEC 60127-2/1, EN 60127-2/1.

**Approvals / Approbationen**

- SEV      UL
- VDE      CSA
- SEMKO    CB-Certificate

**Pre-arcing time/current characteristic (at T<sub>a</sub> 23 °C)**

**Zeit-Strom-Charakteristik (bei T<sub>U</sub> 23 °C)**

Rated current I <sub>n</sub> / Nennstrom I <sub>n</sub>	1,5 · I <sub>n</sub> *		2,1 · I <sub>n</sub>		2,75 · I <sub>n</sub>		4 · I <sub>n</sub>		10 · I <sub>n</sub>
	min.	max.	min.	max.	min.	max.	min.	max.	max.
500 mA – 16A	60 min	30 min	10 ms	2 s**	3 ms	300 ms			20 ms

\* Non fusing current I<sub>nf</sub> / Kleiner Prüfstrom I<sub>nf</sub>  
\*\* for 4 – 16 A max. 3 s / für 4 – 16 A max. 3 s

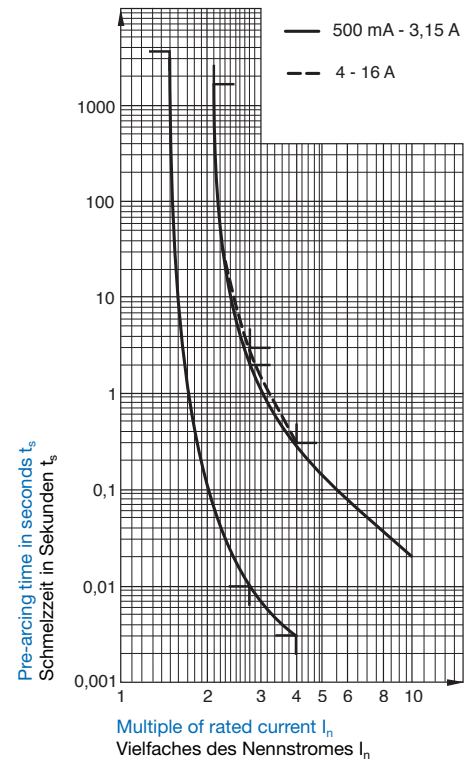

Order No. / Bestell-Nr.	Rated current I <sub>n</sub> / Rated voltage U <sub>n</sub> / Nennstrom I <sub>n</sub> / Nennspannung U <sub>n</sub>	Breaking capacity / Ausschaltvermögen	Voltage drop / Spannungsfall at / bei I <sub>n</sub>		Sustained power dissipation / Verlustleistung at / bei 1,5 I <sub>n</sub>		Pre-arcing I <sup>2</sup> t / Schmelz I <sup>2</sup> t at / bei 10 · I <sub>n</sub>	Approvals / Approbationen					
			IEC 60127 mV	typ. IEC mV	IEC 60127 W	typ. IEC W		typ. A <sup>2</sup> s	SEV	VDE	SEMKO	UL	CSA
0001.1001	500 mA / 250 V	IEC: H = 1500 A / 250 V AC, p.f. / cos φ 0,7-0,8  UL: 10 000 A / 125 V AC, p.f. / cos φ 0,7-0,8 1500 A / 250 V AC p.f. / cos φ 0,7-0,8  UL: 500 A / 125 V AC p.f. / cos φ 0,7-0,8 1000 A / 125 V AC p.f. / cos φ 1 500 A / 250 V AC p.f. / cos φ 1	1800	830	2,5	2,4	9,8 · 10 <sup>-2</sup>	•	•	•	•	•	•
0001.1002	630 mA / 250 V		1500	800	2,5	2,4	2,07 · 10 <sup>-1</sup>	•	•	•	•	•	•
0001.1003	800 mA / 250 V		1200	245	2,5	0,6	2,95 · 10 <sup>-1</sup>	•	•	•	•	•	•
0001.1004	1 A / 250 V		1000	275	2,5	1,0	2,45 · 10 <sup>-1</sup>	•	•	•	•	•	•
0001.1005	1,25 A / 250 V		800	270	4	1,0	5,38 · 10 <sup>-1</sup>	•	•	•	•	•	•
0001.1006	1,6 A / 250 V		600	350	4	1,6	7,55 · 10 <sup>-1</sup>	•	•	•	•	•	•
0001.1007	2 A / 250 V		500	260	4	1,6	2	•	•	•	•	•	•
0001.1008	2,5 A / 250 V		400	260	4	1,9	3,28	•	•	•	•	•	•
0001.1009	3,15 A / 250 V		350	210	4	1,9	6,78	•	•	•	•	•	•
0001.1010	4 A / 250 V		300	200	4	2,4	12,6	•	•	•	•	•	•
0001.1011	5 A / 250 V		250	160	4	2,4	30,8	•	•	•	•	•	•
0001.1012	6,3 A / 250 V		200	150	4	3,2	36,7	•	•	•	•	•	•
0001.1013	8 A / 250 V*			140		3,9	81,9	•	•	•	•	•	•
0001.1014	10 A / 250 V*			130		4,7	141	•	•	•	•	•	•
0001.1015	12,5 A / 250 V*			110		6,9	203						
0001.1016	16 A / 250 V*			120		7,4	461						

\* Not mentioned in the standards / In den Normen nicht enthalten



Available as Pigtail miniature fuse-links, see page 97 /  
Auch als G-Sicherungseinsätze mit Drahtanschlüssen lieferbar, siehe Seite 97

**Miniature fuse-links  
Type SPT 5 x 20**
**time-lag T**  
 high breaking capacity H  
 Ceramic tube

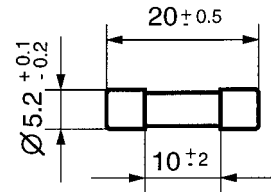
**G-Sicherungseinsätze  
Typ SPT 5 x 20**
**träge T**  
 grosses Ausschaltvermögen H  
 Keramikrohr

**Standards / Normen**

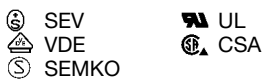
IEC 60127-2/5, EN 60127-2/5.

**Approvals / Approbationen**

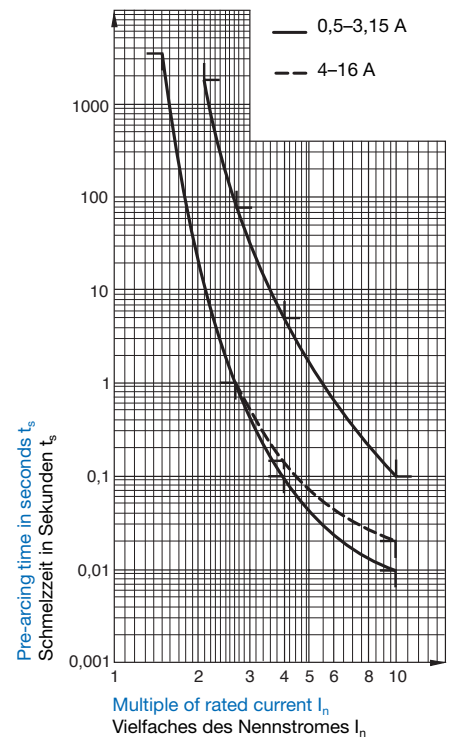
**Pre-arcing time/current  
characteristic (at T<sub>a</sub> 23 °C)**
**Zeit-Strom-Charakteristik  
(bei T<sub>U</sub> 23 °C)**

Rated current I <sub>n</sub> / Nennstrom I <sub>n</sub>	1,5 · I <sub>n</sub> *		2,1 · I <sub>n</sub>		2,75 · I <sub>n</sub>		4 · I <sub>n</sub>		10 · I <sub>n</sub>	
	min.	max.	min.	max.	min.	max.	min.	max.	min.	max.
0,5 – 3,15 A	60 min	30 min	1 s	80 s	95 ms	5 s	10 ms	100 ms		
4 – 16 A	60 min	30 min	1 s	80 s	150 ms	5 s	20 ms	100 ms		

 \* Non fusing current I<sub>nf</sub> / Kleiner Prüfstrom I<sub>nf</sub>

Order No. / Bestell-Nr.	Rated current I <sub>n</sub> / Rated voltage U <sub>n</sub> / Nennstrom I <sub>n</sub> / Nennspannung U <sub>n</sub>	Breaking capacity / Ausschaltvermögen	Voltage drop / Spannungsfall at / bei I <sub>n</sub> max.		Sustained power dissipation / Verlustleistung at / bei 1,5 I <sub>n</sub> max.		Pre-arcing I <sup>2</sup> t / Schmelz I <sup>2</sup> t at / bei 10 · I <sub>n</sub>	Approvals / Approbationen						
			IEC 60127 mV	typ. IEC 60127 mV	IEC 60127 W	typ. IEC 60127 W		typ. A <sup>2</sup> s	SEV	VDE	SEMKO	UL	CSA	
0001.2501	500 mA / 250 V*	IEC: H = 1500 A / 250 V AC, p.f. / cos φ 0,7-0,8  UL: 10 000 A / 125 V AC, p.f. / cos φ 0,7-0,8 1500 A / 250 V AC p.f. / cos φ 0,7-0,8	600	360		0,5	5 · 10 <sup>-1</sup>							
0001.2502	630 mA / 250 V*		600	330		0,5	1,55							
0001.2503	800 mA / 250 V*		500	260		0,5	2,3							
0001.2504	1 A / 250 V		250	180	2,5	0,5	1,1							
0001.2505	1,25 A / 250 V		250	150	2,5	0,5	1,86							
0001.2506	1,6 A / 250 V		200	130	2,5	0,5	4,35							
0001.2507	2 A / 250 V		190	120	2,5	0,6	9,2							
0001.2508	2,5 A / 250 V		180	100	2,5	0,6	11,7							
0001.2509	3,15 A / 250 V		140	100	4	0,8	33,7							
0001.2510	4 A / 250 V		100	90	4	0,9	62,4							
0001.2511	5 A / 250 V		100	90	4	1,2	97,5							
0001.2512	6,3 A / 250 V		100	70	4	1,2	171							
0001.2513	8 A / 250 V*		UL: 1000 A / 250 V AC p.f. / cos φ 1		70		1,3	268						
0001.2514	10 A / 250 V*				70		2,1	400						
0001.2515	12,5 A / 250 V*	UL: 500 A / 125 V AC, p.f. / cos φ 0,7-0,8 1000 A / 125 V AC p.f. / cos φ 1		70		3,1	563							
0001.2516	16 A / 250 V*	500 A / 250 V AC p.f. / cos φ 1		70		4,0	1272							

\* Not mentioned in the standards / In den Normen nicht enthalten



 Available as Pigtail miniature fuse-links, see page 97 /  
 Auch als G-Sicherungseinsätze mit Drahtanschlüssen lieferbar, siehe Seite 97

**Miniature fuse-links  
Type D1**

quick-acting F  
low breaking capacity  
Glass tube

**G-Sicherungseinsätze  
Typ D1**

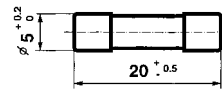
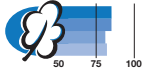
flink F  
kleines Ausschaltvermögen  
Glasrohr



**Approvals / Approbationen**

Qualification approval certificate of quality (CCQ) /  
Qualitätszertifikat (CCQ)

Lists / Listen: GAMT1, NNO

**Pre-arcing time/current  
characteristic (at T<sub>a</sub> 23 °C)**

**Zeit-Strom-Charakteristik  
(bei T<sub>u</sub> 23 °C)**

n · I <sub>n</sub>	n · I <sub>n</sub>		
	1,15 · I <sub>n</sub>	1,65 · I <sub>n</sub>	3 · I <sub>n</sub>
Rated current I <sub>n</sub> / Nennstrom I <sub>n</sub>	min.	max.	max.
0,02 – 6,3 A	1 h	1 h	0,2 s

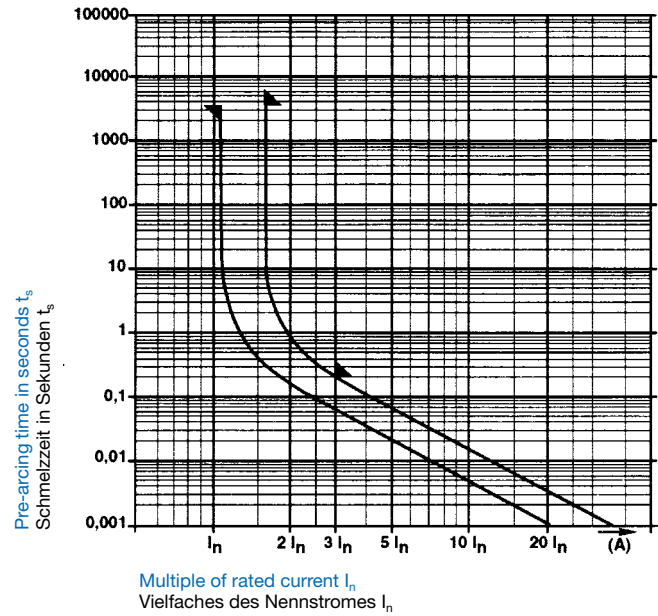

**Standards / Normen**

NF C 93-435 · Model HA21

**Technical data**

Weight ≤ 1,2 g  
Permissible environmental temperature -40 °C to +70 °C  
Climatic range 40 / 070 / 56 (564)  
Derating 0,9 I<sub>n</sub> at 70 °C  
Vibrations NF C 20-706 / IEC 60068-2-6  
10-55 Hz / 0,35 mm / 10 g  
Shocks NF C 20-727 / IEC 60068-2-27, severity: 50 g  
Sinusoidal vibrations NF C 20-729 / IEC 60068-2-29, severity: 40 g  
Salt mist NF C 20-711 / IEC 60068-2-11, total duration: 96 h

**Technische Daten**

Gewicht ≤ 1,2 g  
Zulässige Umgebungstemperatur -40 °C bis +70 °C  
Klimakategorie 40 / 070 / 56 (564)  
Derating 0,9 I<sub>n</sub> bei 70 °C  
Vibrationsbeständigkeit NF C 20-706 / IEC 60068-2-6  
10-55 Hz / 0,35 mm / 10 g  
Schockbeständigkeit NF C 20-727 / IEC 60068-2-27, Stärke: 50 g  
Sinusförm. Vibration NF C 20-729 / IEC 60068-2-29, Stärke: 40 g  
Salznebel NF C 20-711 / IEC 60068-2-11, Dauer: 96 h

Order No. / Bestell-Nr.	Rated current I <sub>n</sub> / Rated voltage U <sub>n</sub> / Nennstrom I <sub>n</sub> / Nennspannung U <sub>n</sub>	Breaking capacity / Ausschaltvermögen	Voltage drop / Spannungsfall at / bei I <sub>n</sub> max.	Sustained power dissipation / Verlustleistung at / bei 1,15 I <sub>n</sub> max.	Pre-arcing I <sup>2</sup> t / Schmelz I <sup>2</sup> t at / bei 10 · I <sub>n</sub>	Approvals / Approbationen		
						CCC	NNO	GAMT1
7010.3110	0,020 A / 220 V*	60 A / 220 V AC, p.f. / cos φ 0,6-0,8	790	0,021	2,7 · 10 <sup>-4</sup>		•	
7010.3120	0,031 A / 220 V*		1400	0,060	2,9 · 10 <sup>-4</sup>		•	
7010.3130	0,040 A / 220 V*		2400	0,155	1,7 · 10 <sup>-4</sup>		•	
7010.3140	0,050 A / 220 V*		3300	0,260	1,7 · 10 <sup>-4</sup>		•	
7010.3150	0,063 A / 220 V*		2250	0,220	4,6 · 10 <sup>-4</sup>		•	
7010.3160	0,080 A / 220 V*		1750	0,215	1,2 · 10 <sup>-3</sup>		•	
7010.3210	0,100 A / 220 V*		1200	0,175	3 · 10 <sup>-3</sup>		•	
7010.3220	0,125 A / 220 V*		1550	0,295	3,7 · 10 <sup>-3</sup>		•	
7010.3230	0,160 A / 220 V*		1300	0,320	7,6 · 10 <sup>-3</sup>		•	
7010.3240	0,200 A / 220 V		1200	0,375	1,2 · 10 <sup>-2</sup>		•	•
7010.3250	0,250 A / 220 V		1000	0,400	2,5 · 10 <sup>-2</sup>		•	•
7010.3260	0,310 A / 220 V		475	0,225	1,8 · 10 <sup>-2</sup>		•	•
7010.3270	0,400 A / 220 V		310	0,185	5,4 · 10 <sup>-2</sup>		•	•
7010.3280	0,500 A / 220 V		285	0,215	9,6 · 10 <sup>-2</sup>		•	•
7010.3290	0,630 A / 220 V		310	0,300	1,4 · 10 <sup>-1</sup>		•	•
7010.3310	0,800 A / 220 V		270	0,335	3 · 10 <sup>-1</sup>		•	•
7010.3410	1 A / 220 V	150	0,215	8,1 · 10 <sup>-1</sup>		•	•	
7010.3420	1,25 A / 220 V	325	0,660	4,7 · 10 <sup>-1</sup>		•	•	
7010.3430	1,60 A / 125 V	300	0,790	9,3 · 10 <sup>-1</sup>		•	•	
7010.3440	2 A / 125 V	300 A / 125 V AC p.f. / cos φ 0,9-1	185	0,560	1,9	•	•	•
7010.3450	2,5 A / 125 V		285	1,250	2,5	•	•	•
7010.3460	3,15 A / 125 V		145	0,670	7,1	•	•	•
7010.3470	4 A / 125 V	60 A / 220 V AC p.f. / cos φ 0,6-0,8	165	1,050	10	•	•	•
7010.3480	5 A / 125 V		165	1,300	18	•	•	•
7010.3510	6,3 A / 125 V		130	1,200	41	•	•	•
7010.3520	8 A / 32 V*		120	1,400	79		•	
7010.3530	10 A / 32 V*		120	1,750	145		•	
7010.3620	12,5 A / 32 V*		115	2	300		•	
7010.3630	15 A / 32 V*		125	2,750	460		•	
7010.3650	20 A / 32 V*		95	2,60	1800		•	

\* Not mentioned in NF C 93-435 / In NF C 93-435 nicht enthalten



**Miniature fuse-links  
Type D1TD**

super-time-lag  
low breaking capacity  
Glass tube

**G-Sicherungseinsätze  
Typ D1TD**

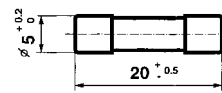

superträge  
kleines Ausschaltvermögen  
Glasrohr



**Standards / Normen**

NF C 93-435 · Model HA20

**Approvals / Approbationen**

-  Qualification approval certificate of quality (CCQ) /  
Qualitätszertifikat (CCQ)
- Lists / Listen: GAMT1, NNO
-  UL Recognition, 125 V AC/DC

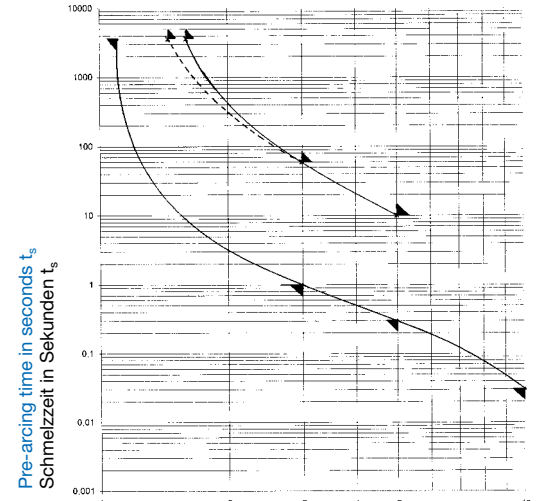

Multiple of rated current  $I_n$   
Vielfaches des Nennstromes  $I_n$

**Pre-arcing time/current  
characteristic (at  $T_a$  23 °C)**

**Zeit-Strom-Charakteristik  
(bei  $T_u$  23 °C)**

Rated current $I_n$ / Nennstrom $I_n$	$1,1 \cdot I_n$		$1,45 \cdot I_n$	$1,6 \cdot I_n$	$3 \cdot I_n$		$5 \cdot I_n$		$10 \cdot I_n$
	min.	max.	max.	min.	max.	min.	max.	min.	
0,031 – 1,25 A	1 h	1 h		1 s	60 s	0,3 s	10 s	30 ms	
1,6 – 15 A	1 h		1 h	1 s	60 s	0,3 s	10 s	30 ms	

**Technical data**

Weight 1,4 g  
Climatic range 40 / 070 / 21 (565)  
Vibrations NF C 20-706 / IEC 60068-2-6  
10-55 Hz / 0,35 mm / 5 cycles  
Shocks NF C 20-727 / IEC 60068-2-27, 50 g  
Salt mist NF C 20-711 / IEC 60068-2-11, 96 h

**Technische Daten**

Gewicht 1,4 g  
Klimakategorie 40 / 070 / 21 (565)  
Vibrationsbeständigkeit NF C 20-706 / IEC 60068-2-6  
10-55 Hz / 0,35 mm / 5 Perioden  
Schockbeständigkeit NF C 20-727 / IEC 60068-2-27, 50 g  
Salznebel NF C 20-711 / IEC 60068-2-11, 96 h

Order No. / Bestell-Nr.	Rated current $I_n$ / Rated voltage $U_n$ / Nennstrom $I_n$ / Nennspannung $U_n$	Breaking capacity Ausschaltvermögen		Voltage drop / according to / Spannungsfall at / bei $1,1 \cdot I_n$ max. mV	Sustained power dissipation / Verlustleistung at / bei $1,1 \cdot I_n$ max. W	Pre-arcing $I^2t$ / Schmelz $I^2t$ at / bei $10 \cdot I_n$ A <sup>2</sup> s	Approvals / Approbationen					
		CCQ	UL				CCQ	NNO	GAMT1	UL (125 V)		
7030.3110	0,031 A / 220 V*	60 A / 220 V AC, p.f. / cos $\varphi$ 1	4000 A / 125 V AC/DC p.f. / cos $\varphi$ 0,9 L/R = 5 ms	3850	0,145	$7,9 \cdot 10^{-2}$						
7030.3120	0,040 A / 220 V*			3150	0,155	$2 \cdot 10^{-1}$						
7030.3130	0,050 A / 220 V			2600	0,160	$2,2 \cdot 10^{-1}$						
7030.3140	0,063 A / 220 V			2000	0,155	$3,5 \cdot 10^{-1}$						
7030.3150	0,080 A / 220 V			1850	0,180	$2,6 \cdot 10^{-1}$						
7030.3210	0,100 A / 220 V			1600	0,190	$2,8 \cdot 10^{-2}$						
7030.3220	0,125 A / 220 V			2000	0,300	$6,1 \cdot 10^{-1}$						
7030.3230	0,160 A / 220 V			745	0,150	$2 \cdot 10^{-1}$						
7030.3240	0,200 A / 220 V			715	0,180	$3,9 \cdot 10^{-1}$						
7030.3250	0,250 A / 220 V			480	0,150	$4 \cdot 10^{-1}$						
7030.3260	0,310 A / 220 V			870	0,340	$2,1 \cdot 10^{-1}$						
7030.3270	0,400 A / 220 V			665	0,340	$6,4 \cdot 10^{-1}$						
7030.3280	0,500 A / 220 V			555	0,360	1						
7030.3290	0,630 A / 220 V			460	0,370	1,6						
7030.3310	0,800 A / 220 V			365	0,370	4,2						
7030.3320	1 A / 220 V			295	0,365	9						
7030.3330	1,25 A / 220 V			300	0,465	7,1						
7040.3110	1,60 A / 125 V			40 A / 125 V AC, p.f. / cos $\varphi$ 0,7-0,8	100 A / 125 V AC, p.f. / cos $\varphi$ 0,9	280	0,535	22				
7040.3120	2 A / 125 V					245	0,595	43				
7040.3130	2,5 A / 125 V					210	0,630	128				
7040.3140	3,15 A / 125 V	160	0,615			370						
7040.3150	4 A / 125 V	165	0,790			260						
7040.3160	5 A / 125 V	175	1,100			440						
7040.3170	6,3 A / 125 V	105	0,775			800						
7040.3180	8 A / 125 V*	105	1,000			1400						
7040.3190	10 A / 125 V*	90	1,050			2200						
7040.3200	12,5 A / 32 V*	100 A / 32 V AC, p.f. / cos $\varphi$ 0,9				55	0,795	890				
7040.3210	15 A / 32 V*			45	0,745	3400						

\* Not mentioned in NF C 93-435 / In NF C 93-435 nicht enthalten

**Miniature fuse-links  
Type 172581**

**quick-acting F**  
high breaking capacity  
Ceramic tube

**G-Sicherungseinsätze  
Typ 172581**

**fliink F**  
groses Ausschaltvermögen  
Keramikrohr

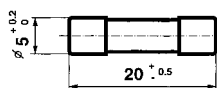

**Standards / Normen**

NF C 93-435 · Model HA38

**Approvals / Approbationen**

Lists / Listen: GAMT1, NNO

**Pre-arcing time/current  
characteristic (at T<sub>a</sub> 23 °C)**

**Zeit-Strom-Charakteristik  
(bei T<sub>u</sub> 23 °C)**

$n \cdot I_n$	$1,1 \cdot I_n$	$1,7 \cdot I_n$	$3 \cdot I_n$
Rated current $I_n$ / Nennstrom $I_n$	min.	max.	max.
0,16 – 6,3 A	1 h	1 h	2 s

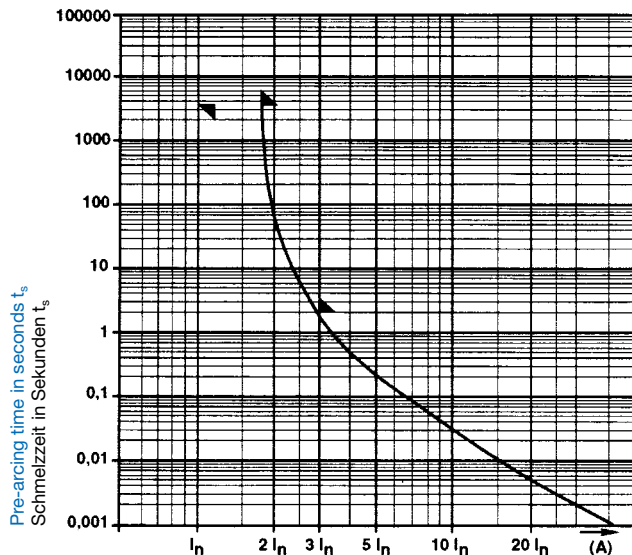

Multiple of rated current  $I_n$   
Vielfaches des Nennstromes  $I_n$

**Technical data**

Weight 1,4 g  
Permissible environmental temperature -40 °C + 125 °C  
Derating 0,9  $I_n$  at 125 °C  
Climatic range 40 / 125 / 56 (534)  
Vibrations NF C 20-706 / IEC 60068-2-6  
10-55 Hz / 0,35 mm / 5 cycles  
Shocks NF C 20-727 / IEC 60068-2-27, 50 g  
Salt mist NF C 20-711 / IEC 60068-2-11, 96 h  
Sinusoidal vibrations NF C 20-729 / IEC 60068-2-11, 40 g

**Technische Daten**

Gewicht 1,4 g  
Zulässige Umgebungstemperatur -40 °C + 125 °C  
Derating 0,9  $I_n$  bei 125 °C  
Klimakategorie 40 / 125 / 56 (534)  
Vibrationsbeständigkeit NF C 20-706 / IEC 60068-2-6  
10-55 Hz / 0,35 mm / 5 Perioden  
Schockbeständigkeit NF C 20-727 / IEC 60068-2-27, 50 g  
Salznebel NF C 20-711 / IEC 60068-2-11, 96 h  
Sinusförm. Vibration NF C 20-729 / IEC 60068-2-11, 40 g

Order No. / Bestell-Nr.	Rated current $I_n$ / Rated voltage $U_n$ / Nennstrom $I_n$ / Nennspannung $U_n$	Breaking capacity / Ausschaltvermögen max.	Voltage drop / Spannungsfall at / bei $I_n$ max. mV	Sustained power dissipation / Verlustleistung at / bei $1,1 \cdot I_n$ max. W	Pre-arcing $I^2t$ / Schmelz $I^2t$ at / bei $10 \cdot I_n$	Approvals / Approba- tionen NNO GAMT1	
7020.3800	0,160 A / 125 V DC / 250 V AC	300 A / 125 V DC	2250	0,475	$2,3 \cdot 10^{-3}$	• •	
7020.3820	0,250 A / 125 V DC / 250 V AC		1650	0,540	$8,7 \cdot 10^{-3}$	• •	
7020.3840	0,400 A / 125 V DC / 250 V AC		1550	0,835	$2,5 \cdot 10^{-2}$	• •	
7020.3860	0,630 A / 125 V DC / 250 V AC		730	0,600	$3,9 \cdot 10^{-2}$	• •	
7020.3880	1 A / 125 V DC / 250 V AC		150 A / 250 V AC p.f. / cos $\varphi$ 0,7-0,8	555	0,725	$1,5 \cdot 10^{-1}$	• •
7020.3900	1,60 A / 125 V DC / 250 V AC			480	0,990	$5,3 \cdot 10^{-1}$	• •
7020.3920	2,50 A / 125 V DC / 250 V AC			225	0,690	4,5	• •
7020.3940	4 A / 125 V DC / 250 V AC			200	0,990	46	• •
7020.3960	6,30 A / 125 V DC / 250 V AC			150	1,200	67	• •

**Pigtail miniature fuse-links  
Type SP 5 x 20**
**quick acting F**  
high breaking capacity

**G-Sicherungseinsätze mit Drahtanschlüssen  
Typ SP 5 x 20**
**flik F**  
grosses Ausschaltvermögen

Order No. / Bestell-Nr.		$I_n / U_n$
0001.1001.PT	0001.1001.TR	500 mA / 250 V
0001.1002.PT	0001.1002.TR	630 mA / 250 V
0001.1003.PT	0001.1003.TR	800 mA / 250 V
0001.1004.PT	0001.1004.TR	1 A / 250 V
0001.1005.PT	0001.1005.TR	1,25 A / 250 V
0001.1006.PT	0001.1006.TR	1,6 A / 250 V
0001.1007.PT	0001.1007.TR	2 A / 250 V
0001.1008.PT	0001.1008.TR	2,5 A / 250 V
0001.1009.PT	0001.1009.TR	3,15 A / 250 V
0001.1010.PT	0001.1010.TR	4 A / 250 V
0001.1011.PT	0001.1011.TR	5 A / 250 V
0001.1012.PT	0001.1012.TR	6,3 A / 250 V
0001.1013.PT	0001.1013.TR	8 A / 250 V

Technical data see page 92 / Technische Daten siehe Seite 92

**Pigtail miniature fuse-links  
Type SPT 5 x 20**
**time-lag T**  
high breaking capacity

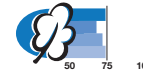
**G-Sicherungseinsätze mit Drahtanschlüssen  
Typ SPT 5 x 20**
**träge T**  
grosses Ausschaltvermögen

Order No. / Bestell-Nr.		$I_n / U_n$
0001.2504.PT	0001.2504.TR	1 A / 250 V
0001.2505.PT	0001.2505.TR	1,25 A / 250 V
0001.2506.PT	0001.2506.TR	1,6 A / 250 V
0001.2507.PT	0001.2507.TR	2 A / 250 V
0001.2508.PT	0001.2508.TR	2,5 A / 250 V
0001.2509.PT	0001.2509.TR	3,15 A / 250 V
0001.2510.PT	0001.2510.TR	4 A / 250 V
0001.2511.PT	0001.2511.TR	5 A / 250 V
0001.2512.PT	0001.2512.TR	6,3 A / 250 V
0001.2513.PT	0001.2513.TR	8 A / 250 V

Technical data see page 93 / Technische Daten siehe Seite 93

**Pigtail miniature fuse-links  
Type FSF 5 2 20**
**quick acting F**  
low breaking capacity

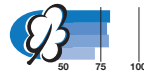
**G-Sicherungseinsätze mit Drahtenden  
Typ FSF 5 2 20**
**flik F**  
kleines Ausschaltvermögen

Order No. / Bestell-Nr.		$I_n / U_n$
0034.1513.PT	0034.1513.TR	500 mA / 250 V
0034.1514.PT	0034.1514.TR	630 mA / 250 V
0034.1515.PT	0034.1515.TR	800 mA / 250 V
0034.1516.PT	0034.1516.TR	1 A / 250 V
0034.1517.PT	0034.1517.TR	1,25 A / 250 V
0034.1518.PT	0034.1518.TR	1,6 A / 250 V
0034.1519.PT	0034.1519.TR	2 A / 250 V
0034.1520.PT	0034.1520.TR	2,5 A / 250 V
0034.1521.PT	0034.1521.TR	3,15 A / 250 V
0034.1522.PT	0034.1522.TR	4 A / 250 V
0034.1523.PT	0034.1523.TR	5 A / 250 V
0034.1524.PT	0034.1524.TR	6,3 A / 250 V
0034.1525.PT	0034.1525.TR	8 A / 250 V

Technical data see page 85 / Technische Daten siehe Seite 85

**Pigtail miniature fuse-links  
Type FST 5 2 20**
**time-lag T**  
low breaking capacity

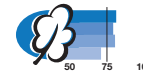
**G-Sicherungseinsätze mit Drahtenden  
Typ FST 5 2 20**
**träge T**  
kleines Ausschaltvermögen

Order No. / Bestell-Nr.		$I_n / U_n$
0034.3104.PT	0034.3104.TR	50 mA / 250 V
0034.3105.PT	0034.3105.TR	63 mA / 250 V
0034.3106.PT	0034.3106.TR	80 mA / 250 V
0034.3107.PT	0034.3107.TR	100 mA / 250 V
0034.3108.PT	0034.3108.TR	125 mA / 250 V
0034.3109.PT	0034.3109.TR	160 mA / 250 V
0034.3110.PT	0034.3110.TR	200 mA / 250 V
0034.3111.PT	0034.3111.TR	250 mA / 250 V
0034.3112.PT	0034.3112.TR	315 mA / 250 V
0034.3113.PT	0034.3113.TR	400 mA / 250 V
0034.3114.PT	0034.3114.TR	500 mA / 250 V
0034.3115.PT	0034.3115.TR	630 mA / 250 V
0034.3116.PT	0034.3116.TR	800 mA / 250 V
0034.3117.PT	0034.3117.TR	1 A / 250 V
0034.3118.PT	0034.3118.TR	1,25 A / 250 V
0034.3165.PT	0034.3165.TR	1,4 A / 250 V
0034.3119.PT	0034.3119.TR	1,6 A / 250 V
0034.3120.PT	0034.3120.TR	2 A / 250 V
0034.3121.PT	0034.3121.TR	2,5 A / 250 V
0034.3122.PT	0034.3122.TR	3,15 A / 250 V
0034.3123.PT	0034.3123.TR	4 A / 250 V
0034.3124.PT	0034.3124.TR	5 A / 250 V
0034.3125.PT	0034.3125.TR	6,3 A / 250 V
0034.3126.PT	0034.3126.TR	8 A / 250 V

Technical data see page 86 / Technische Daten siehe Seite 86

**Packaging / Verpackung:**

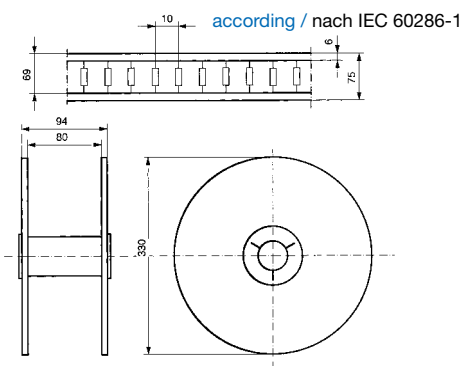
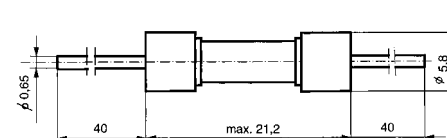
 00XX.XXXX.PT Boxes of 1000 pieces / lose à 1000 Stück  
 00XX.XXXX.TR Taped and reeled / gegurtet à 1000 Stück

**Dimensions / Abmessungen**

Notes: see page 116 / Hinweise: siehe Seite 116

**Miniature fuse-links with melting indicator Type D1V**

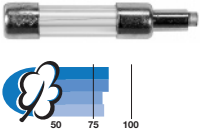
quick-acting F  
low breaking capacity  
Glass tube



**G-Sicherungseinsätze mit Kennmelder Typ D1V**

flink F  
kleines Ausschaltvermögen  
Glasrohr

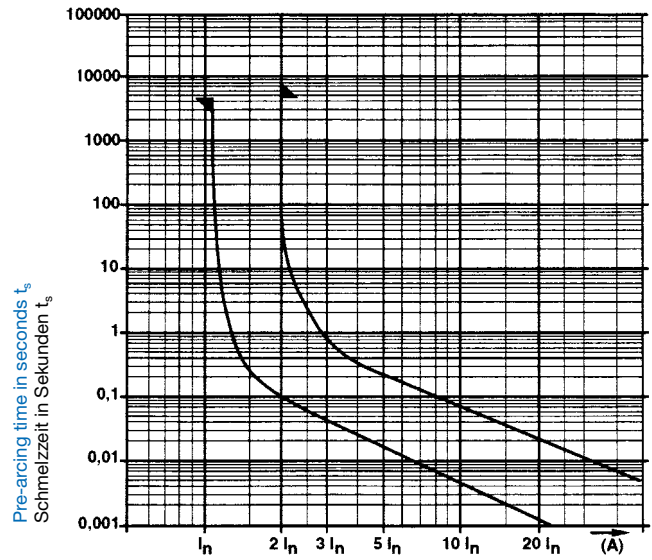
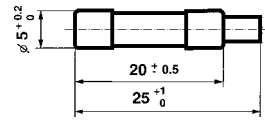

**Standards / Normen**

none / keine

**Approvals / Approbationen**

Lists / Listen: NNO

**Pre-arcing time/current characteristic (at T<sub>a</sub> 23 °C)**

Rated current I <sub>n</sub> / Nennstrom I <sub>n</sub>	n · I <sub>n</sub>	1,1 · I <sub>n</sub>	2 · I <sub>n</sub>
		min.	max.
0,25 – 10 A		1 h	1 h

**Zeit-Strom-Charakteristik (bei T<sub>u</sub> 23 °C)**

**Technical data**

Weight 1,5 g

**Technische Daten**

Gewicht 1,5 g

Order No. / Bestell-Nr.	Rated current I <sub>n</sub> / Rated voltage U <sub>n</sub> / Nennstrom I <sub>n</sub> / Nennspannung U <sub>n</sub>	Breaking capacity / Ausschaltvermögen	Voltage drop / Spannungsfall at / bei I <sub>n</sub> max.	Sustained power dissipation / Verlustleistung at / bei 1,1 · I <sub>n</sub> max.	Pre-arcing I <sup>2</sup> t / Schmelz I <sup>2</sup> t at / bei 10 · I <sub>n</sub>	Approvals / Approbationen
			mV	W	A <sup>2</sup> s	NNO
7039.1610	0,250 A / 125 V	100 A / 125 V AC p.f. / cos φ 0,9	2500	0,730	1,5 · 10 <sup>-2</sup>	•
7039.1630	0,310 A / 125 V		2450	0,935	2,1 · 10 <sup>-2</sup>	•
7039.1640	0,400 A / 125 V		2150	1,050	4 · 10 <sup>-2</sup>	•
7039.1650	0,500 A / 125 V		1850	1,150	8,6 · 10 <sup>-2</sup>	•
7039.1670	0,630 A / 125 V		1550	1,200	1,7 · 10 <sup>-1</sup>	•
7039.1680	0,800 A / 125 V		1200	1,200	3,9 · 10 <sup>-1</sup>	•
7039.1690	1 A / 125 V		1250	1,500	6,5 · 10 <sup>-1</sup>	•
7039.1720	1,25 A / 125 V		1400	2,100	8,6 · 10 <sup>-1</sup>	•
7039.1730	1,60 A / 125 V		385	0,890	6,7 · 10 <sup>-1</sup>	•
7039.1740	2 A / 125 V		280	0,780	1,4	•
7039.1750	2,50 A / 125 V		200	0,680	3,7	•
7039.1770	3,15 A / 125 V		210	0,900	5,8	•
7039.1780	4 A / 125 V		200	1,100	10	•
7039.1790	5 A / 125 V		200	1,400	20	•
7039.1820	6,3 A / 125 V		185	1,550	31	•
7039.1910	8 A / 125 V		160	1,750	65	•
7039.1920	10 A / 125 V	140	2,000	110	•	

**FUSES / SICHERUNGEN** NON RESETTABLE / NICHT RÜCKSTELLEND (1/4" x 1 1/4") 6,3 x 32 mm

**Miniature fuse-links**  
Type FSF 6,3 x 32

quick-acting F  
low breaking capacity L  
Glass tube

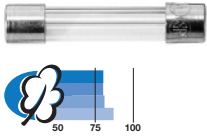

**G-Sicherungseinsätze**  
Typ FSF 6,3 x 32

flink F  
kleines Ausschaltvermögen L  
Glasrohr

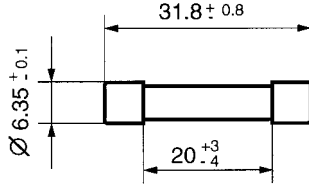

**Standards / Normen**

IEC 60127-2/4, EN 60127-2/4.

**Approvals / Approbationen**

none / keine

**Pre-arcing time/current characteristic (at T<sub>a</sub> 23 °C)**



**Zeit-Strom-Charakteristik (bei T<sub>u</sub> 23 °C)**

n · I <sub>n</sub> Rated current I <sub>n</sub> / Nennstrom I <sub>n</sub>	1,15 · I <sub>n</sub> *		2 · I <sub>n</sub>		2,75 · I <sub>n</sub>		4 · I <sub>n</sub>		10 · I <sub>n</sub>	
	min.	max.	min.	max.	min.	max.	min.	max.	max.	max.
100 mA	60 min	20 s	2 ms	200 ms	1 ms	30 ms	5 ms			
125 mA – 10 A	60 min	20 s	20 ms	1500 ms	8 ms	400 ms	80 ms			

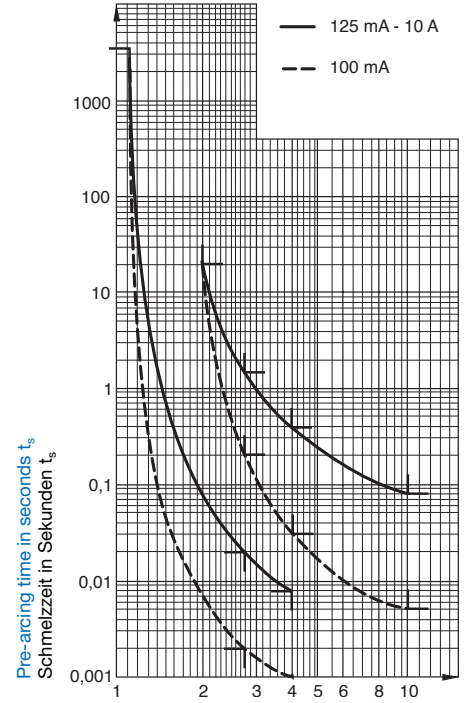
\* Non fusing current I<sub>nf</sub> / Kleiner Prüfstrom I<sub>nf</sub>



Multiple of rated current I<sub>n</sub>  
Vielfaches des Nennstromes I<sub>n</sub>

Order No. / Bestell-Nr.	Rated current I <sub>n</sub> / Rated voltage U <sub>n</sub> / Nennstrom I <sub>n</sub> / Nennspannung U <sub>n</sub>	Breaking capacity / Ausschaltvermögen	Voltage drop / Spannungsfall at / bei I <sub>n</sub> max.		Sustained power dissipation / Verlustleistung at / bei 1,15 · I <sub>n</sub> max.		Pre-arcing I <sup>2</sup> t / Schmelz I <sup>2</sup> t at / bei 10 · I <sub>n</sub>  A <sup>2</sup> s
			IEC 60127 mV	typ.  mV	IEC 60127 W	typ.  W	
0034.1736	100 mA / 250 V	L = 35 A / 250 V AC, p.f. / cos φ 1	6000	4200	1,6	0,6	on request / auf Anfrage
0034.1737	125 mA / 250 V		5500	3600	1,6	0,6	
0034.1738	160 mA / 250 V		5000	1700	1,6	0,6	
0034.1739	200 mA / 250 V		4000	3500	1,6	1,0	
0034.1740	250 mA / 250 V		3500	2300	1,6	0,9	
0034.1741	315 mA / 250 V		3000	2000	1,6	0,9	
0034.1742	400 mA / 250 V		2500	1700	1,6	0,9	
0034.1743	500 mA / 250 V		2000	1700	1,6	1,4	
0034.1744	630 mA / 250 V		1800	1400	1,6	1,5	
0034.1745	800 mA / 250 V		1500	1300	1,6	1,5	
0034.1746	1 A / 250 V		500	370	1,6	0,5	
0034.1747	1,25 A / 250 V		400	350	2,5	0,6	
0034.1748	1,6 A / 250 V		400	350	2,5	0,6	
0034.1749	2 A / 250 V		300	280	2,5	1,0	
0034.1750	2,5 A / 250 V*		250	240	2,5	0,9	
0034.1751	3,15 A / 250 V*		250	230	4	1,9	
0034.1752	4 A / 250 V*		250	230	4	1,4	
0034.1753	5 A / 250 V**	200	180	4	2,0		
0034.1754	6,3 A / 250 V**	200	140	4	1,4		
0034.1755	8 A / 250 V**	200	200	4	2,7		
0034.1756	10 A / 250 V**	200	180	4	3,1		

\* 150 V rated voltage according to the standard / Nennspannung gemäss Norm

\*\* 60 V rated voltage according to the standard / Nennspannung gemäss Norm

**Miniature fuse-links**  
**Type FST 6,3 x 32**

**time-lag T**  
low breaking capacity  
Glass tube

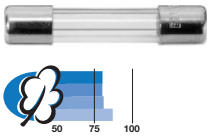

**G-Sicherungseinsätze**  
**Typ FST 6,3 x 32**

**träge T**  
kleines Ausschaltvermögen  
Glasrohr

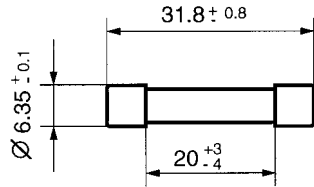

**Standards / Normen**

none / keine

**Approvals / Approbationen**

none / keine

**Pre-arcing time/current characteristic (at T<sub>a</sub> 23 °C)**

**Zeit-Strom-Charakteristik (bei T<sub>u</sub> 23 °C)**

n · I <sub>n</sub> Rated current I <sub>n</sub> / Nennstrom I <sub>n</sub>	2 · I <sub>n</sub>		2,75 · I <sub>n</sub>		4 · I <sub>n</sub>		10 · I <sub>n</sub>	
	min.	max.	min.	max.	min.	max.	min.	max.
20 mA – 2 A	800 ms*	20 s*	150 ms*	3 s*	60 ms	1 s	10 ms	200 ms
2,5 – 20A	800 ms	20 s	200 ms	6 s	80 ms	2 s	15 ms	300 ms

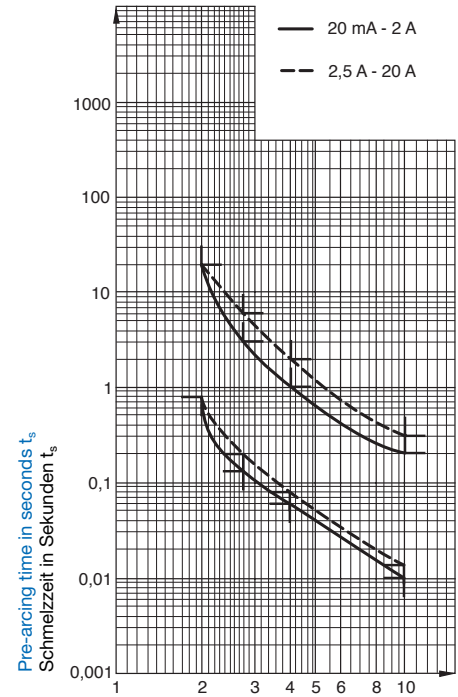

Multiple of rated current I<sub>n</sub>  
Vielfaches des Nennstromes I<sub>n</sub>

Non fusing current I<sub>nf</sub> / Kleiner Prüfstrom I<sub>nf</sub> = 1,15 I<sub>n</sub>  
\* These values are not guaranteed at 20 mA /  
Diese Werte werden bei 20 mA nicht garantiert

Order No. / Bestell-Nr.	Rated current I <sub>n</sub> / Rated voltage U <sub>n</sub> / Nennstrom I <sub>n</sub> / Nennspannung U <sub>n</sub>	Breaking capacity / Ausschaltvermögen	Voltage drop / Spannungsfall at / bei I <sub>n</sub>		Sustained power dissipation / Verlustleistung at / bei 1,15 · I <sub>n</sub>	Pre-arcing I <sup>2</sup> t / Schmelz I <sup>2</sup> t at / bei 10 · I <sub>n</sub>
			max. mV	typ. mV	typ. W	A <sup>2</sup> s
0034.3401	20 mA / 250 V	35 A / 250 V AC, p.f. / cos φ 1	5500	2800	0,1	on request / auf Anfrage
0034.3402	32 mA / 250 V		5500	2700	0,1	
0034.3403	40 mA / 250 V		5000	2100	0,1	
0034.3404	50 mA / 250 V		5000	1600	0,1	
0034.3405	63 mA / 250 V		4000	1500	0,1	
0034.3406	80 mA / 250 V		3400	1100	0,1	
0034.3407	100 mA / 250 V		2500	940	0,1	
0034.3408	125 mA / 250 V		2000	890	0,1	
0034.3409	160 mA / 250 V		1700	770	0,1	
0034.3410	200 mA / 250 V		1400	840	0,2	
0034.3411	250 mA / 250 V		1200	590	0,2	
0034.3412	315 mA / 250 V		900	200	0,1	
0034.3413	400 mA / 250 V		650	180	0,1	
0034.3414	500 mA / 250 V		550	140	0,1	
0034.3415	630 mA / 250 V		450	140	0,1	
0034.3416	800 mA / 250 V		320	140	0,1	
0034.3417	1 A / 250 V		270	140	0,2	
0034.3418	1,25 A / 250 V		250	100	0,2	
0034.3419	1,6 A / 250 V		200	100	0,2	
0034.3420	2 A / 250 V		200	90	0,2	
0034.3421	2,5 A / 250 V	200	80	0,3		
0034.3422	3,15 A / 250 V	200	80	0,3		
0034.3423	4 A / 250 V	10 · I <sub>n</sub> / 250 V AC p.f. / cos φ 1	200	80	0,4	
0034.3424	5 A / 250 V		200	80	0,5	
0034.3425	6,3 A / 250 V		200	80	0,7	
0034.3426	8 A / 250 V		200	120	1,5	
0034.3427	10 A / 250 V		200	110	1,6	
0034.3428	12,5 A / 250 V		180	100	1,7	
0034.3429	16 A / 250 V		150	90	2,2	
0034.3430	20 A / 250 V		150	100	3,3	

**FUSES / SICHERUNGEN**    **NON RESETTABLE / NICHT RÜCKSTELLEND**    (1/4" x 1 1/4")    **6,3 x 32 mm**

**Miniature fuse-links**  
**Type FTT 6,3 x 32**  
 super-time-lag TT  
 low breaking capacity  
 Glass tube

**G-Sicherungseinsätze**  
**Typ FTT 6,3 x 32**  
 superträge TT  
 kleines Ausschaltvermögen  
 Glasrohr

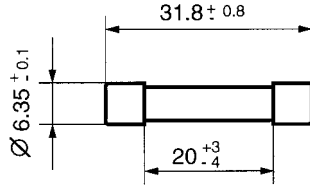
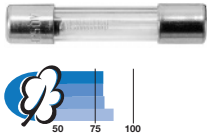

**Standards / Normen**

none / keine

**Approvals / Approbationen**

none / keine

**Pre-arcing time/current characteristic (at T<sub>a</sub> 23 °C)**

**Zeit-Strom-Charakteristik (bei T<sub>U</sub> 23 °C)**

n · I <sub>n</sub> Rated current I <sub>n</sub> / Nennstrom I <sub>n</sub>	1,2 · I <sub>n</sub> *		1,75 · I <sub>n</sub>		2,1 · I <sub>n</sub>		2,75 · I <sub>n</sub>		4 · I <sub>n</sub>		5 · I <sub>n</sub>	
	min.	max.	min.	max.	min.	max.	min.	max.	min.	max.	min.	max.
100 mA – 4 A	60 min	30 min	6 s	120 s	2 s	30 s	800 ms	15 s	0,6 s	10 s		

\* Non fusing current I<sub>nf</sub> / Kleiner Prüfstrom I<sub>nf</sub>

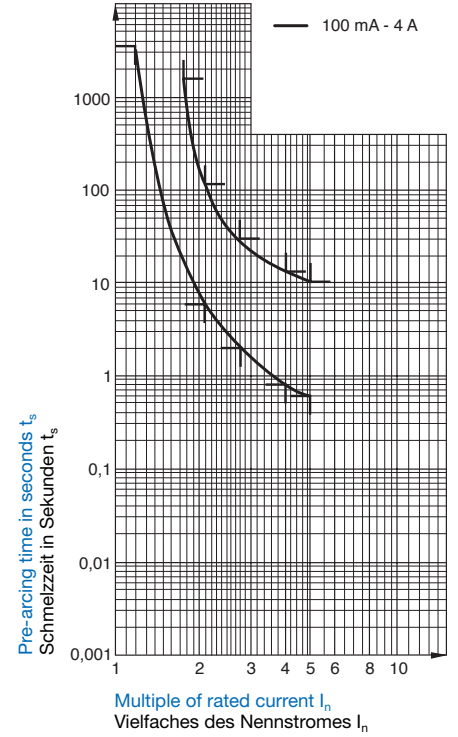

Order No. / Bestell-Nr.	Rated current I <sub>n</sub> / Rated voltage U <sub>n</sub> / Nennstrom I <sub>n</sub> / Nennspannung U <sub>n</sub>	Breaking capacity / Ausschaltvermögen	Voltage drop / Spannungsfall at / bei I <sub>n</sub>		Sustained power dissipation / Verlustleistung at / bei 1,2 · I <sub>n</sub>	Pre-arcing I <sup>2</sup> t / Schmelz I <sup>2</sup> t at / bei 10 · I <sub>n</sub>
			max. mV	typ. mV		
0034.5503	100 mA / 250 V	35 A / 250 V AC, p.f. / cos φ 1	6000	5800	1,0	on request / auf Anfrage
0034.5504	125 mA / 250 V		4000	3900	0,7	
0034.5505	160 mA / 250 V		3000	2700	0,6	
0034.5506	200 mA / 250 V		2000	1900	0,7	
0034.5507	250 mA / 250 V		2000	1800	0,6	
0034.5508	315 mA / 250 V		1500	1400	0,9	
0034.5509	400 mA / 250 V		1500	1400	0,9	
0034.5510	500 mA / 250 V		1200	1100	0,9	
0034.5511	630 mA / 250 V		1000	1000	0,9	
0034.5512	800 mA / 250 V		900	800	1,0	
0034.5513	1 A / 250 V		800	650	1,3	
0034.5514	1,25 A / 250 V		700	530	1,3	
0034.5515	1,6 A / 250 V		400	210	0,5	
0034.5516	2 A / 250 V		200	200	0,7	
0034.5517	2,5 A / 250 V		200	180	0,7	
0034.5518	3,15 A / 250 V		200	150	0,8	
0034.5519	4 A / 250 V	150	100	0,7		

**Miniature fuse-links**  
**Type FSF 6,3 x 32**  
 quick-acting F  
 Glass tube

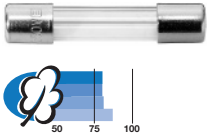

**G-Sicherungseinsätze**  
**Typ FSF 6,3 x 32**  
 flink F  
 Glasrohr

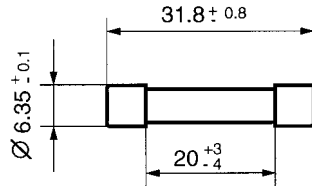

**Standards / Normen**

UL 248-14 (formerly / früher 198.G)  
 CSA C22.2 No. 248.14 (formerly / früher 59.2 M)

**Approvals / Approbationen**



**Pre-arcing time/current characteristic (at T<sub>a</sub> 23 °C)**

n · I <sub>n</sub>	1,1 · I <sub>n</sub> *	1,35 · I <sub>n</sub>	2 · I <sub>n</sub>
Rated current I <sub>n</sub> / Nennstrom I <sub>n</sub>	min.	max.	max.
0,1 – 15A	4 h	1 h	5 s

**Zeit-Strom-Charakteristik (bei T<sub>u</sub> 23 °C)**

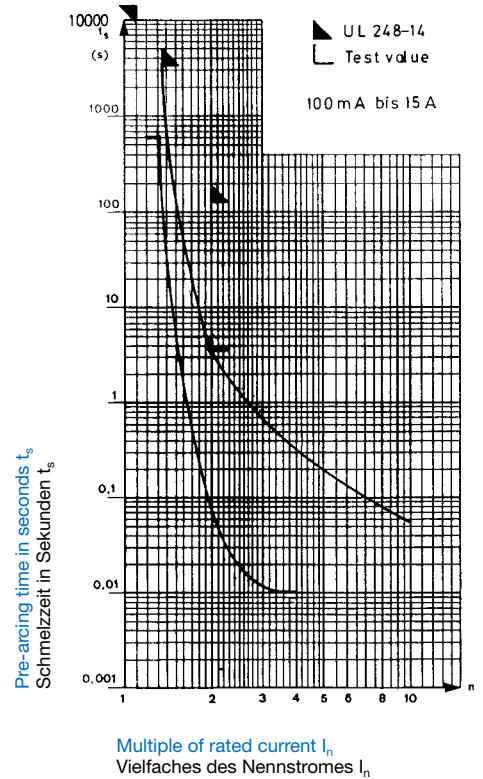

\* Non fusing current I<sub>nf</sub> / Kleiner Prüfstrom I<sub>nf</sub>

Order No. / Bestell-Nr.	Rated current I <sub>n</sub> / Rated voltage U <sub>n</sub> / Nennstrom I <sub>n</sub> / Nennspannung U <sub>n</sub>	Breaking capacity / Ausschaltvermögen	Voltage drop / Spannungsfall at / bei I <sub>n</sub>	Sustained power dissipation / Verlustleistung at / bei 1,1 I <sub>n</sub>	Pre-arcing I <sup>2</sup> t / Schmelz I <sup>2</sup> t at / bei 10 · I <sub>n</sub>	Approvals / Approbationen
0034.5107	100 mA / 250 V	10000 A / 125 V AC / p.f. / cos φ 0,7-0,8	max. mV	max. W	on request / auf Anfrage	UL
0034.5108	125 mA / 250 V		5651	0,93		CSA
0034.5109	150 mA / 250 V		5200	1,05		• •
0034.5111	175 mA / 250 V		4950	1,16		• •
0034.5112	187 mA / 250 V		4900	1,26		• •
0034.5113	200 mA / 250 V		4700	1,4		• •
0034.5114	250 mA / 250 V		4500	1,43		• •
0034.5115	300 mA / 250 V		4200	1,8		• •
0034.5117	375 mA / 250 V		4100	1,88		• •
0034.5119	500 mA / 250 V		4000	2,25		• •
0034.5120	600 mA / 250 V		450	0,33		• •
0034.5123	750 mA / 250 V		440	0,38		• •
0034.5125	1 A / 250 V		389	0,42		• •
0034.5127	1,25 A / 250 V		344	0,56		• •
0034.5128	1,5 A / 250 V		330	0,6		• •
0034.5129	1,6 A / 250 V		315	0,72		• •
0034.5131	2 A / 250 V		308	0,75		• •
0034.5133	2,5 A / 250 V		250	0,9		• •
0034.5135	3 A / 250 V		240	1,02		• •
0034.5138	4 A / 250 V		239	1,14		• •
0034.5139	5 A / 250 V	203	1,5	• •		
0034.5140	6 A / 250 V	178	2,0	• •		
0034.5143	7 A / 250 V	177	2,1	• •		
0034.5144	8 A / 250 V	171	2,25	• •		
0034.5145	10 A / 250 V	165	2,55	• •		
0034.5146	12 A / 125 V	162	2,85	• •		
0034.5147	15 A / 125 V	157	3,45	• •		
		150	3,9	• •		



**FUSES / SICHERUNGEN**

**NON RESETTABLE / NICHT RÜCKSTELLEND**

(1/4" x 1 1/4") **6,3 x 32 mm**

**Miniature fuse-links  
Type FST 6,3 x 32**

time-delay  
Glass tube

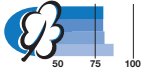

**G-Sicherungseinsätze  
Typ FST 6,3 x 32**

träge  
Glasrohr

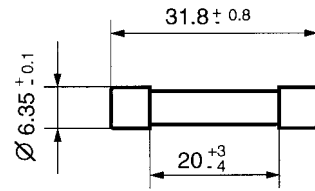

**Standards / Normen**

UL 248-14 (formerly / früher 198.G)  
CSA C22.2 No. 248.14 (formerly / früher 59.2 M)

**Approvals / Approbationen**



**Pre-arcing time/current  
characteristic (at T<sub>a</sub> 23 °C)**

**Zeit-Strom-Charakteristik  
(bei T<sub>u</sub> 23 °C)**

n · I <sub>n</sub> Rated current I <sub>n</sub> / Nennstrom I <sub>n</sub>	1,1 · I <sub>n</sub> *		2 · I <sub>n</sub>	
	min.	max.	min.	max.
0,062 – 15 A	4 h	1 h	5 s	30 s

\* Non fusing current I<sub>nf</sub> / Kleiner Prüfstrom I<sub>nf</sub>

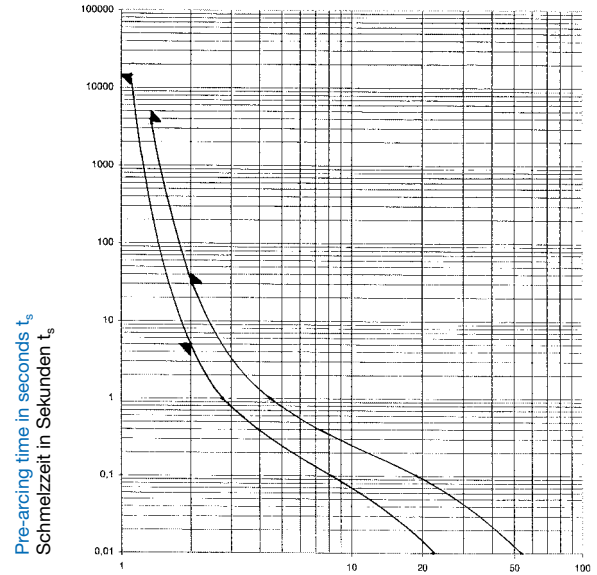

Multiple of rated current I<sub>n</sub>  
Vielfaches des Nennstromes I<sub>n</sub>

Order No. / Bestell-Nr.	Rated current I <sub>n</sub> / Rated voltage U <sub>n</sub> / Nennstrom I <sub>n</sub> / Nennspannung U <sub>n</sub>	Breaking capacity / Ausschaltvermögen	Voltage drop / Spannungsfall at / bei I <sub>n</sub> max.	Sustained power dissipation / Verlustleistung at / bei 1,1 I <sub>n</sub> max.	Pre-arcing I <sup>2</sup> t / Schmelzzeit I <sup>2</sup> t at / bei 10 · I <sub>n</sub>	Approvals / Approbationen	
						UL	CSA
0034.5204	63 mA / 250 V	10000 A / 125 V AC / p.f. / cos φ 0,7–0,8	7500	1,05	1,21 · 10 <sup>-1</sup>	•	•
0034.5207	100 mA / 250 V		4500	1,17	2,1 · 10 <sup>-1</sup>	•	•
0034.5208	125 mA / 250 V		4136	1,22	2,88 · 10 <sup>-1</sup>	•	•
0034.5209	150 mA / 250 V		3502	1,28	4,4 · 10 <sup>-1</sup>	•	•
0034.5211	175 mA / 250 V		3150	1,31	5 · 10 <sup>-1</sup>	•	•
0034.5212	187 mA / 250 V		2850	1,34	5,2 · 10 <sup>-1</sup>	•	•
0034.5213	200 mA / 250 V		2808	1,35	9,85 · 10 <sup>-1</sup>	•	•
0034.5214	250 mA / 250 V		2334	1,41	6,4 · 10 <sup>-1</sup>	•	•
0034.5215	300 mA / 250 V		1950	1,46	1,27	•	•
0034.5217	375 mA / 250 V		1800	1,58	1,38	•	•
0034.5219	500 mA / 250 V		1125	1,8	3,34	•	•
0034.5220	600 mA / 250 V		1081	1,88	4,91	•	•
0034.5223	750 mA / 250 V		931	2,03	9,04	•	•
0034.5224	800 mA / 250 V		876	2,1	10,5	•	•
0034.5225	1 A / 250 V		750	2,21	16,7	•	•
0034.5226	1,2 A / 250 V		729	2,25	18,5	•	•
0034.5227	1,25 A / 250 V		537	2,3	20,8	•	•
0034.5228	1,5 A / 250 V		531	2,33	25	•	•
0034.5229	1,6 A / 250 V		450	2,37	32,5	•	•
0034.5230	1,8 A / 250 V		435	2,4	33,4	•	•
0034.5231	2 A / 250 V	427	2,48	47,1	•	•	
0034.5232	2,25 A / 250 V	393	2,52	50,5	•	•	
0034.5233	2,5 A / 250 V	359	2,57	108	•	•	
0034.5234	2,8 A / 250 V	330	2,61	126	•	•	
0034.5235	3 A / 250 V	325	2,66	180	•	•	
0034.5237	3,2 A / 250 V	319	2,7	136	•	•	
0034.5238	4 A / 250 V	286	2,75	232	•	•	
0034.5239	5 A / 250 V	270	2,84	620	•	•	
0034.5241	6,25 A / 250 V	180	1,4		•	•	
0034.5243	7 A / 250 V	156	1,47		•	•	
0034.5244	8 A / 250 V	140	1,53		•	•	
0034.5245	10 A / 125 V	91	2,7	538	•	•	
0034.5246	12 A / 125 V	90	3,3	765	•	•	
0034.5247	15 A / 125 V	90	4,5	1930	•	•	

**Miniature fuse-links  
Type SA 6,3 x 32**

super-quick acting FF  
high breaking capacity  
Ceramic or glass tube

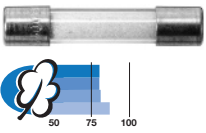

**G-Sicherungseinsätze  
Typ SA 6,3 x 32**

superflink FF  
groses Ausschaltvermögen  
Keramik- oder Glasrohr

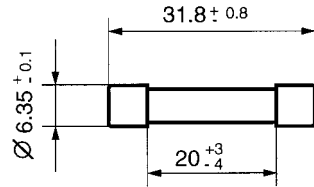

**Standards / Normen**

none / keine

**Approvals / Approbationen**

none / keine

**Pre-arcing time/current characteristic (at T<sub>a</sub> 23 °C)**

**Zeit-Strom-Charakteristik (bei T<sub>u</sub> 23 °C)**

Rated current I <sub>n</sub> / Nennstrom I <sub>n</sub>	1,2 · I <sub>n</sub> *		2 · I <sub>n</sub>		2,75 · I <sub>n</sub>		4 · I <sub>n</sub>		10 · I <sub>n</sub>
	min.	max.	min.	max.	min.	max.	min.	max.	max.
1,6 – 5 A	60 min	10 ms	2 s	4 ms	200 ms	2 ms	40 ms	5 ms	
6,3 – 16 A	60 min	10 ms	2 s	4 ms	50 ms	2 ms	15 ms	2 ms	

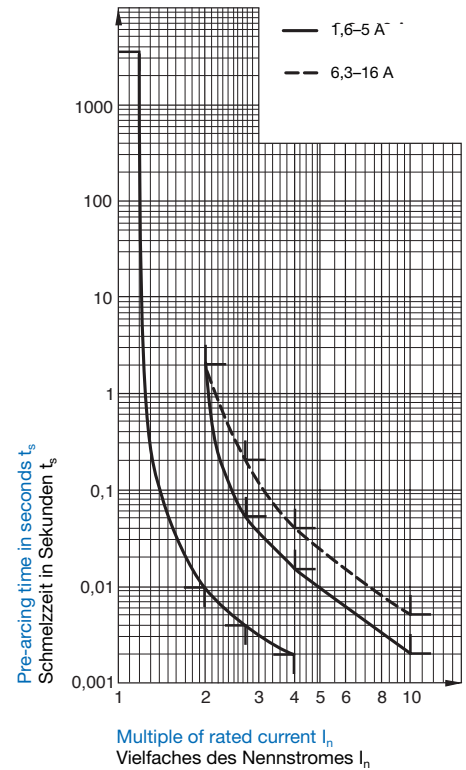

\* Non fusing current I<sub>nf</sub> / Kleiner Prüfstrom I<sub>nf</sub>

Order No. / Bestell-Nr.	Rated current I <sub>n</sub> / Rated voltage U <sub>n</sub> / Nennstrom I <sub>n</sub> / Nennspannung U <sub>n</sub>	Breaking capacity / Ausschaltvermögen	Voltage drop / Spannungsfall at / bei I <sub>n</sub>		Sustained power dissipation / Verlustleistung at / bei 1,2 I <sub>n</sub>	Pre-arcing I <sup>2</sup> t / Schmelz I <sup>2</sup> t at / bei 10 · I <sub>n</sub>
			max. mV	typ. mV		
0034.1001	1,6 A / 250 V	1500 A at/ bei 250 V AC p.f. / cos φ 0,7-0,8	700	500	1,4	on request / auf Anfrage
0034.1002	2 A / 250 V		600	470	1,6	
0034.1003	2,5 A / 250 V		600	440	2,0	
0034.1004	3,15 A / 250 V		600	370	2,1	
0034.1005	3,5 A / 250 V		500	450	2,7	
0034.1006	4 A / 250 V		500	450	3,2	
0034.1007	5 A / 250 V		400	330	3,3	
0034.1008	6,3 A / 250 V		400	200	2,4	
0034.1009	8 A / 250 V		350	220	3,6	
0034.1010	10 A / 250 V		350	190	3,6	
0034.1011	12,5 A / 250 V		300	160	4,6	
0034.1012	16 A / 250 V		200	180	6,6	

**FUSES / SICHERUNGEN** NON RESETTABLE / NICHT RÜCKSTELLEND (1/4" x 1 1/4") 6,3 x 32 mm

**Miniature fuse-links**  
Type SP 6,3 x 32

quick-acting F  
high breaking capacity  
Ceramic or glass tube

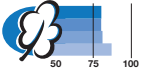

**G-Sicherungseinsätze**  
Typ SP 6,3 x 32

flink F  
grosses Ausschaltvermögen  
Keramik- oder Glasrohr

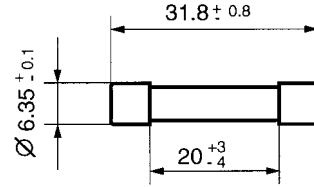

**Standards / Normen**

none / keine

**Approvals / Approbationen**

none / keine

**Pre-arcing time/current characteristic (at T<sub>a</sub> 23 °C)**

**Zeit-Strom-Charakteristik (bei T<sub>u</sub> 23 °C)**

n · I <sub>n</sub> Rated current I <sub>n</sub> / Nennstrom I <sub>n</sub>	1,5 · I <sub>n</sub> *		2,1 · I <sub>n</sub>		2,75 · I <sub>n</sub>		4 · I <sub>n</sub>		10 · I <sub>n</sub>	
	min.	max.	min.	max.	min.	max.	min.	max.	min.	max.
500 mA – 4 A	60 min	60 min	70 ms	5 s	10 ms	150 ms	10 ms	150 ms	10 ms	10 ms
5 – 20 A	60 min	60 min**	150 ms	2 s	25 ms	200 ms	25 ms	200 ms	20 ms	20 ms

\* Non fusing current I<sub>nf</sub> / Kleiner Prüfstrom I<sub>nf</sub>

\*\* at 1,9 · I<sub>n</sub> / bei 1,9 · I<sub>n</sub>

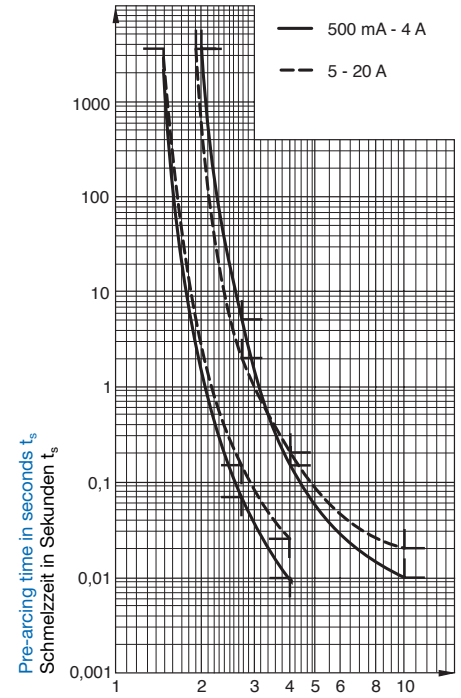

Multiple of rated current I<sub>n</sub>  
Vielfaches des Nennstromes I<sub>n</sub>

Order No. / Bestell-Nr.	Rated current I <sub>n</sub> / Rated voltage U <sub>n</sub> / Nennstrom I <sub>n</sub> / Nennspannung U <sub>n</sub>	Breaking capacity / Ausschaltvermögen	Voltage drop / Spannungsfall at / bei I <sub>n</sub>		Sustained power dissipation / Verlustleistung at / bei 1,5 I <sub>n</sub>	Pre-arcing I <sup>2</sup> t / Schmelz I <sup>2</sup> t at / bei 10 · I <sub>n</sub>	
			max. mV	typ. mV			typ. W
0001.1021	500 mA / 250 V	1500 A / 250 V AC, p.f. / cos φ 0,7-0,8	3000	1000	3,0	on request / auf Anfrage	
0001.1022	630 mA / 250 V		2500	2500	3,8		
0001.1023	800 mA / 250 V		2200	520	1,2		
0001.1024	1 A / 250 V		1900	410	1,2		
0001.1025	1,25 A / 250 V		1600	1600	5,4		
0001.1026	1,6 A / 250 V		1300	460	2,1		
0001.1027	2 A / 250 V		1000	340	2,0		
0001.1028	2,5 A / 250 V		700	350	2,8		
0001.1029	3,15 A / 250 V		600	270	3,0		
0001.1030	4 A / 250 V		550	270	3,5		
0001.1031	5 A / 250 V		500	240	3,7		
0001.1032	6,3 A / 250 V		450	170	4,7		
0001.1033	8 A / 250 V		400	250	6,7		
0001.1034	10 A / 250 V		350	150	5,2		
0001.1035	12,5 A / 250 V		1000 A / 250 V AC p.f. / cos φ 0,7-0,8	300	150		7,6
0001.1036	16 A / 250 V			250	130		8,4
0001.1037	20 A / 250 V	250		130	11,5		

**Miniature fuse-links**  
Type SPT 6,3 x 32

time-lag T  
high breaking capacity  
Ceramic or glass tube

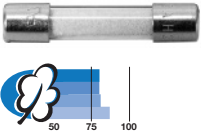

**G-Sicherungseinsätze**  
Typ SPT 6,3 x 32

träge T  
grosses Ausschaltvermögen  
Keramik- oder Glasrohr

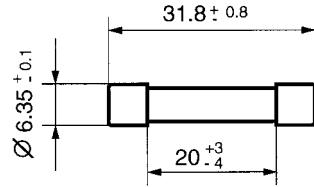

**Standards / Normen**

UL 248-14 (formerly / früher 198.G)

**Approvals / Approbationen**



**Pre-arcing time/current characteristic (at T<sub>a</sub> 23 °C)**

**Zeit-Strom-Charakteristik (bei T<sub>u</sub> 23 °C)**

n · I <sub>n</sub> Rated current I <sub>n</sub> / Nennstrom I <sub>n</sub>	1,5 · I <sub>n</sub> *		2,1 · I <sub>n</sub>		2,75 · I <sub>n</sub>		4 · I <sub>n</sub>		10 · I <sub>n</sub>	
	min.	max.	min.	max.	min.	max.	min.	max.	min.	max.
500 mA – 4 A	60 min	60 min	2 s	40 s	150 ms	2,5 s	5 ms	40 ms		
5 – 32 A	60 min	60 min**	3 s	50 s	400 ms	4 s	15 ms	100 ms		

\* Non fusing current I<sub>nf</sub> / Kleiner Prüfstrom I<sub>nf</sub>

\*\* at 1,9 · I<sub>n</sub> / bei 1,9 · I<sub>nf</sub>

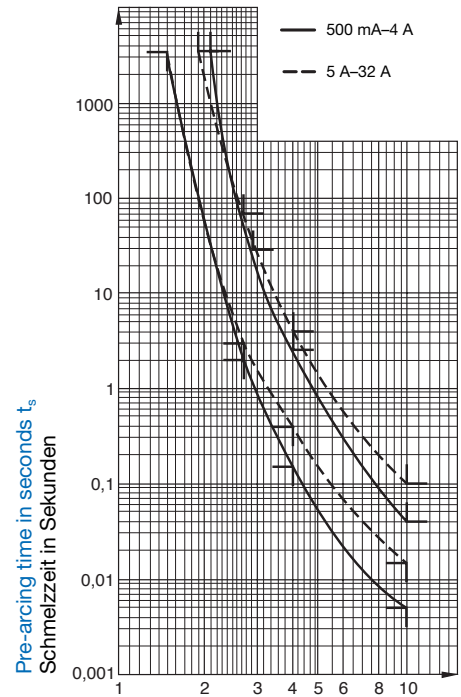

Multiple of rated current I<sub>n</sub>  
Vielfaches des Nennstromes I<sub>n</sub>

Order No. / Bestell-Nr.	Rated current I <sub>n</sub> / Rated voltage U <sub>n</sub> / Nennstrom I <sub>n</sub> / Nennspannung U <sub>n</sub>	Breaking capacity / Ausschaltvermögen	Voltage drop / Spannungsfall at / bei I <sub>n</sub>		Sustained power dissipation / Verlustleistung at / bei 1,5 I <sub>n</sub>	Pre-arcing I <sup>2</sup> t / Schmelz I <sup>2</sup> t at / bei 10 · I <sub>n</sub>	Approvals / Approbationen
			max. mV	typ. mV			
0001.2521	500 mA / 250 V	1500 A / 250 V AC, p.f. / cos φ 0,7-0,8	2500	2400	3,1	on request / auf Anfrage	UL
0001.2522	630 mA / 250 V		2000	560	0,9		
0001.2523	800 mA / 250 V		1200	490	1,0		
0001.2524	1 A / 250 V		900	350	0,9		
0001.2525	1,25 A / 250 V		700	170	0,5		
0001.2526	1,6 A / 250 V		500	240	1,0		
0001.2527	2 A / 250 V		400	200	1,1		
0001.2528	2,5 A / 250 V		350	150	1,0		
0001.2529	3,15 A / 250 V		300	160	1,5		
0001.2530	4 A / 250 V		250	130	1,5		
0001.2531	5 A / 250 V	250	110	1,5			
0001.2532	6,3 A / 250 V	250	110	1,9			
0001.2533	8 A / 250 V	200	70	1,6			
0001.2534	10 A / 250 V	200	70	2,0			
0001.2535	12,5 A / 250 V	200	70	2,3			
0001.2536	16 A / 250 V	150	70	3,8			
0001.2537	20 A / 250 V	150	70	4,3			
0001.2538	25 A / 150 V	1000 A / 150 V AC p.f. / cos φ 1	150	70	5,1		
0001.2539	32 A / 150 V	1000 A / 150 V AC p.f. / cos φ 1	150	70	8,6		

**FUSES / SICHERUNGEN** NON RESETTABLE / NICHT RÜCKSTELLEND (1/4" x 1 1/4") 6,3 x 32 mm

**Miniature fuse-links**  
Type A12FA 250 V

super-quick-acting FF  
high breaking capacity  
Ceramic tube

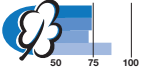

**Standards / Normen**

none / keine

**Approvals / Approbationen**

 UL

**G-Sicherungseinsätze**  
Typ A 12FA 250 V

superflink FF  
grosses Ausschaltvermögen  
Keramikrohr

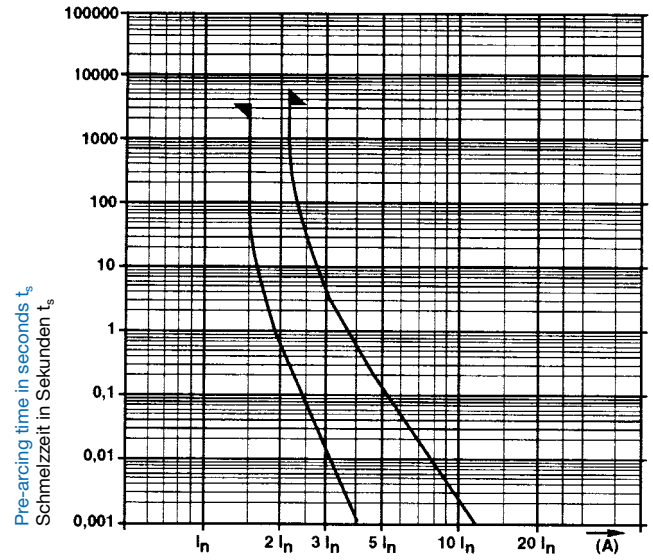
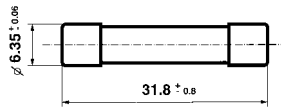

Multiple of rated current  $I_n$   
Vielfaches des Nennstromes  $I_n$

**Pre-arcing time/current characteristic (at  $T_a$  23 °C)**

Rated current $I_n$ / Nennstrom $I_n$	$n \cdot I_n$	
	$1,5 \cdot I_n$	$2,1 \cdot I_n$
	min.	max.
0,1 – 20 A	1 h	1 h

**Zeit-Strom-Charakteristik (bei  $T_u$  23 °C)**

**Technical data**

Weight 3 g

**Technische Daten**

Gewicht 3 g

Order No. / Bestell-Nr.	Rated current $I_n$ / Rated voltage $U_n$ / Nennstrom $I_n$ / Nennspannung $U_n$	Breaking capacity / Ausschaltvermögen	Voltage drop / Spannungsfall at / bei $I_n$	Sustained power dissipation / Verlustleistung at / bei $1,5 \cdot I_n$	Pre-arcing $I^2t$ / Schmelz $I^2t$ at / bei $10 \cdot I_n$	Approvals / Approbationen
7022.0250	0,100 A / 250 V	200 kA / 250 V AC p.f. / $\cos \varphi \geq 0,2$	max. 2600 mV	max. 1,5 W	$1,5 \cdot 10^{-3} A^2s$	• UL
7022.0260	0,125 A / 250 V		2300	1,5	$2,9 \cdot 10^{-3}$	•
7022.0270	0,160 A / 250 V		1700	1,4	$5,8 \cdot 10^{-3}$	•
7022.0280	0,200 A / 250 V		1500	1,2	$1,3 \cdot 10^{-2}$	•
7022.0290	0,250 A / 250 V		1500	2,2	$1,9 \cdot 10^{-2}$	•
7022.0300	0,315 A / 250 V		2150	4,1	$2,2 \cdot 10^{-2}$	•
7022.0310	0,400 A / 250 V		2750	2,85	$2,3 \cdot 10^{-2}$	•
7022.0320	0,500 A / 250 V		2850	3,65	$4,1 \cdot 10^{-2}$	•
7022.0330	0,630 A / 250 V		2000	3,2	$1 \cdot 10^{-1}$	•
7022.0340	0,800 A / 250 V		2050	4,15	$1,7 \cdot 10^{-1}$	•
7022.0350	1 A / 250 V		1750	4,45	$4,4 \cdot 10^{-1}$	•
7022.0360	1,25 A / 250 V		740	4,15	$2 \cdot 10^{-1}$	•
7022.0370	1,60 A / 250 V		570	3,05	$5,4 \cdot 10^{-1}$	•
7022.0380	2 A / 250 V		615	4,5	$8,1 \cdot 10^{-1}$	•
7022.0390	2,50 A / 250 V		465	4,35	1,8	•
7022.0400	3,15 A / 250 V		440	5	3,4	•
7022.0410	4 A / 250 V		335	4,8	8,1	•
7022.0420	5 A / 250 V		395	7,7	12	•
7022.0430	6,30 A / 250 V		170	3	6	•
7022.0440	8 A / 250 V		135	3	15	•
7022.0450	10 A / 250 V	155	4,75	20	•	
7022.0460	12,50 A / 250 V	210		15	•	
7022.0470	16 A / 250 V	270		25	•	

**Miniature fuse-links  
Type A12FA 380 V**

super-quick-acting FF  
high breaking capacity  
Ceramic tube

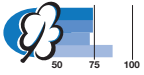

**G-Sicherungseinsätze  
Typ A 12FA 380 V**

superflink FF  
groses Ausschaltvermögen  
Keramikrohr

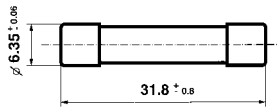

**Standards / Normen**

none / keine

**Approvals / Approbationen**



**Pre-arcing time/current  
characteristic (at T<sub>a</sub> 23 °C)**

Rated current I <sub>n</sub> / Nennstrom I <sub>n</sub>	n · I <sub>n</sub>	
	1,5 · I <sub>n</sub>	2,1 · I <sub>n</sub>
	min.	max.
0,1 – 12,5 A	1 h	1 h

**Zeit-Strom-Charakteristik  
(bei T<sub>u</sub> 23 °C)**

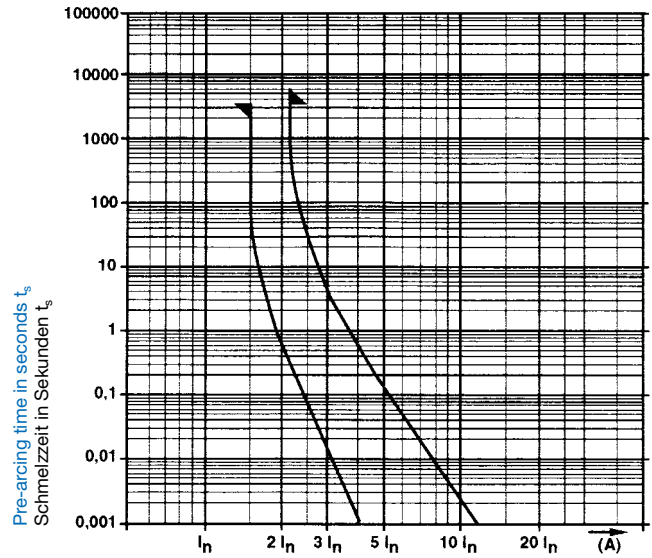

Multiple of rated current I<sub>n</sub>  
Vielfaches des Nennstromes I<sub>n</sub>

**Technical data**

Weight 3 g

**Technische Daten**

Gewicht 3 g

Order No. / Bestell-Nr.	Rated current I <sub>n</sub> / Rated voltage U <sub>n</sub> / Nennstrom I <sub>n</sub> / Nennspannung U <sub>n</sub>	Breaking capacity / Ausschaltvermögen	Voltage drop / Spannungsfall at / bei I <sub>n</sub>	Sustained power dissipation / Verlustleistung at / bei 1,5 · I <sub>n</sub>	Pre-arcing I <sup>2</sup> t / Schmelz I <sup>2</sup> t at / bei 10 · I <sub>n</sub>	Approvals / Approbationen
7022.0000	0,100 A / 380 V	150 kA / 380 V AC p.f. / cos φ ≥ 0,2	max. mV	max. W	A <sup>2</sup> s	UL
7022.0010	0,125 A / 380 V		2600	1,5	1,5 · 10 <sup>-3</sup>	•
7022.0020	0,160 A / 380 V		2300	1,5	2,9 · 10 <sup>-3</sup>	•
7022.0030	0,200 A / 380 V		1700	1,4	5,8 · 10 <sup>-3</sup>	•
7022.0040	0,250 A / 380 V		1500	1,2	1,3 · 10 <sup>-2</sup>	•
7022.0050	0,315 A / 380 V		1500	2,2	1,9 · 10 <sup>-2</sup>	•
7022.0060	0,400 A / 380 V		2150	4,1	2,2 · 10 <sup>-2</sup>	•
7022.0070	0,500 A / 380 V		2750	2,85	2,3 · 10 <sup>-2</sup>	•
7022.0080	0,630 A / 380 V		2850	3,65	4,1 · 10 <sup>-2</sup>	•
7022.0090	0,800 A / 380 V		2000	3,2	1 · 10 <sup>-1</sup>	•
7022.0100	1 A / 380 V		2050	4,15	1,7 · 10 <sup>-1</sup>	•
7022.0110	1,25 A / 380 V		1750	4,45	4,4 · 10 <sup>-1</sup>	•
7022.0120	1,60 A / 380 V		740	4,15	2 · 10 <sup>-1</sup>	•
7022.0130	2 A / 380 V		570	3,05	5,4 · 10 <sup>-1</sup>	•
7022.0140	2,50 A / 380 V		615	4,50	8,1 · 10 <sup>-1</sup>	•
7022.0150	3,15 A / 380 V		465	4,35	1,8	•
7022.0160	4 A / 380 V		440	5	3,4	•
7022.0170	5 A / 380 V		335	4,8	8,1	•
7022.0180	6,30 A / 380 V		395	7,7	12	•
7022.0190	8 A / 380 V		170	3	6	•
7022.0200	10 A / 380 V	135	3	15	•	
7022.0210	12,50 A / 380 V	155	4,75	20	•	
		210		15	•	

**FUSES / SICHERUNGEN** NON RESETTABLE / NICHT RÜCKSTELLEND (1/4" x 1 1/4") 6,3 x 32 mm

**Miniature fuse-links**  
**Type A12FA 500 V**  
 super-quick-acting FF  
 high breaking capacity  
 Ceramic tube

**G-Sicherungseinsätze**  
**Typ A 12FA 500 V**  
 superflink FF  
 grosses Ausschaltvermögen  
 Keramikrohr

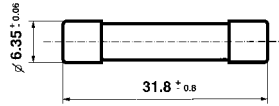
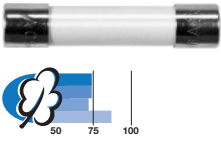

**Standards / Normen**

none / keine

**Approvals / Approbationen**

 UL

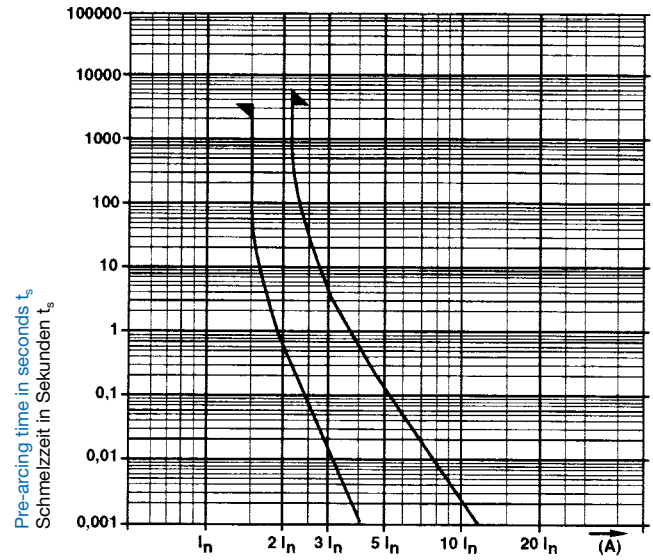

Multiple of rated current  $I_n$   
 Vielfaches des Nennstromes  $I_n$

**Pre-arcing time/current characteristic (at  $T_a$  23 °C)**

**Zeit-Strom-Charakteristik (bei  $T_U$  23 °C)**

Rated current $I_n$ / Nennstrom $I_n$	$n \cdot I_n$	$1,5 \cdot I_n$	$2,1 \cdot I_n$
		min.	max.
0,1 – 12,5 A		1 h	1 h

**Technical data**

Weight 3 g

**Technische Daten**

Gewicht 3 g

Order No. / Bestell-Nr.	Rated current $I_n$ / Rated voltage $U_n$ / Nennstrom $I_n$ / Nennspannung $U_n$	Breaking capacity / Ausschaltvermögen	Voltage drop / Spannungsfall at / bei $I_n$	Sustained power dissipation / Verlustleistung at / bei $1,5 \cdot I_n$	Pre-arcing $I^2t$ / Schmelz $I^2t$ at / bei $10 \cdot I_n$	Approvals / Approbationen
			max. mV	max. W	$A^2s$	
7022.0500	0,100 A / 500 V	150 kA / 500 V AC p.f. / $\cos \varphi \geq 0,2$	2600	1,5	$1,5 \cdot 10^{-3}$	•
7022.0510	0,125 A / 500 V		2300	1,5	$2,9 \cdot 10^{-3}$	•
7022.0520	0,160 A / 500 V		1700	1,4	$5,8 \cdot 10^{-3}$	•
7022.0530	0,200 A / 500 V		1500	1,2	$1,3 \cdot 10^{-2}$	•
7022.0540	0,250 A / 500 V		1500	2,2	$1,9 \cdot 10^{-2}$	•
7022.0550	0,315 A / 500 V		2150	4,1	$2,2 \cdot 10^{-2}$	•
7022.0560	0,400 A / 500 V		2750	2,85	$2,3 \cdot 10^{-2}$	•
7022.0570	0,500 A / 500 V		2850	3,65	$4,1 \cdot 10^{-2}$	•
7022.0580	0,630 A / 500 V		2000	3,2	$1 \cdot 10^{-1}$	•
7022.0590	0,800 A / 500 V		2050	4,15	$1,7 \cdot 10^{-1}$	•
7022.0600	1 A / 500 V		1750	4,45	$4,4 \cdot 10^{-1}$	•
7022.0610	1,25 A / 500 V		740	4,15	$2 \cdot 10^{-1}$	•
7022.0620	1,60 A / 500 V		570	3,05	$5,4 \cdot 10^{-1}$	•
7022.0630	2 A / 500 V		615	4,5	$8,1 \cdot 10^{-1}$	•
7022.0640	2,50 A / 500 V		465	4,35	1,8	•
7022.0650	3,15 A / 500 V		440	5	3,4	•
7022.0660	4 A / 500 V		335	4,8	8,1	•
7022.0670	5 A / 500 V	395	7,7	12	•	
7022.0680	6,30 A / 500 V	170	3	6	•	
7022.0690	8 A / 500 V	135	3	15	•	
7022.0700	10 A / 500 V	155	4,75	20	•	
7022.0710	12,50 A / 500 V	210	210	15	•	

**Miniature fuse-links**  
**Type A12FA 660 V**  
 super-quick-acting FF  
 high breaking capacity  
 Ceramic tube

**G-Sicherungseinsätze**  
**Typ A 12FA 660 V**  
 superflink FF  
 grosses Ausschaltvermögen  
 Keramikrohr

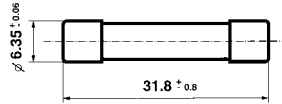
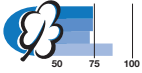

**Standards / Normen**

none / keine

**Approvals / Approbationen**

UL

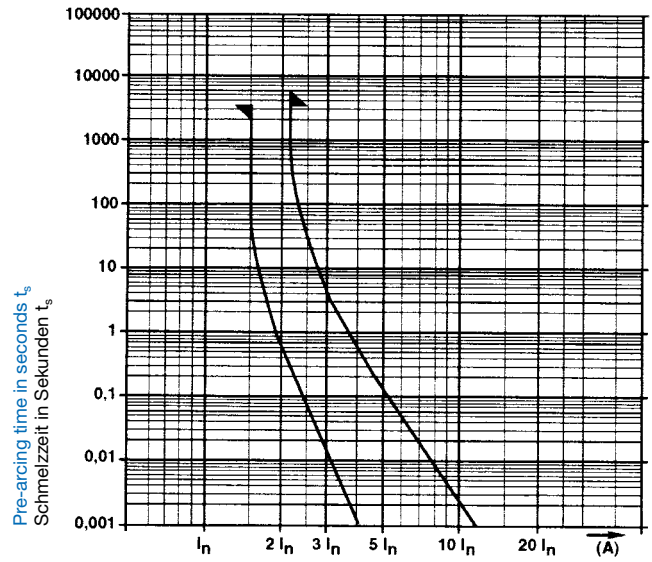

Multiple of rated current  $I_n$   
 Vielfaches des Nennstromes  $I_n$

**Pre-arcing time/current characteristic (at  $T_a$  23 °C)**

**Zeit-Strom-Charakteristik (bei  $T_u$  23 °C)**

Rated current $I_n$ / Nennstrom $I_n$	$n \cdot I_n$	
	$1,5 \cdot I_n$	$2,1 \cdot I_n$
	min.	max.
0,1 – 2 A	1 h	1 h

**Technical data**

Weight 3 g

**Technische Daten**

Gewicht 3 g

Order No. / Bestell-Nr.	Rated current $I_n$ / Rated voltage $U_n$ / Nennstrom $I_n$ / Nennspannung $U_n$	Breaking capacity / Ausschaltvermögen	Voltage drop / Spannungsfall at / bei $I_n$	Sustained power dissipation / Verlustleistung at / bei $1,5 \cdot I_n$	Pre-arcing $I^2t$ / Schmelz $I^2t$ at / bei $10 \cdot I_n$	Approvals / Approbationen
7022.0750	0,100 A / 660 V	30 kA / 660 V AC p.f. / $\cos \varphi \geq 0,2$	max. mV	max. W	$A^2s$	UL
7022.0760	0,125 A / 660 V		2600	1,5	$1,5 \cdot 10^{-3}$	•
7022.0770	0,160 A / 660 V		2300	1,5	$2,9 \cdot 10^{-3}$	•
7022.0780	0,200 A / 660 V		1700	1,4	$5,8 \cdot 10^{-3}$	•
7022.0790	0,250 A / 660 V		1500	1,2	$1,3 \cdot 10^{-2}$	•
7022.0800	0,315 A / 660 V		1500	2,2	$1,9 \cdot 10^{-2}$	•
7022.0810	0,400 A / 660 V		2150	4,1	$2,2 \cdot 10^{-2}$	•
7022.0820	0,500 A / 660 V		2750	2,85	$2,3 \cdot 10^{-2}$	•
7022.0830	0,630 A / 660 V		2850	3,65	$4,1 \cdot 10^{-2}$	•
7022.0840	0,800 A / 660 V		2000	3,2	$1 \cdot 10^{-1}$	•
7022.0850	1 A / 660 V		2050	4,15	$1,7 \cdot 10^{-1}$	•
7022.0860	1,25 A / 660 V		1750	4,45	$4,4 \cdot 10^{-1}$	•
7022.0870	1,60 A / 660 V		740	4,15	$2 \cdot 10^{-1}$	•
7022.0880	2 A / 660 V		570	3,05	$5,4 \cdot 10^{-1}$	•
		615	4,5	$8,1 \cdot 10^{-1}$	•	



**FUSES / SICHERUNGEN** NON RESETTABLE / NICHT RÜCKSTELLEND (1/4" x 1 1/4") 6,3 x 32 mm

**Miniature fuse-links  
Type A12BK**

quick-acting F  
high breaking capacity  
Ceramic tube

**G-Sicherungseinsätze  
Typ A12BK**

flink F  
grosses Ausschaltvermögen  
Keramikrohr

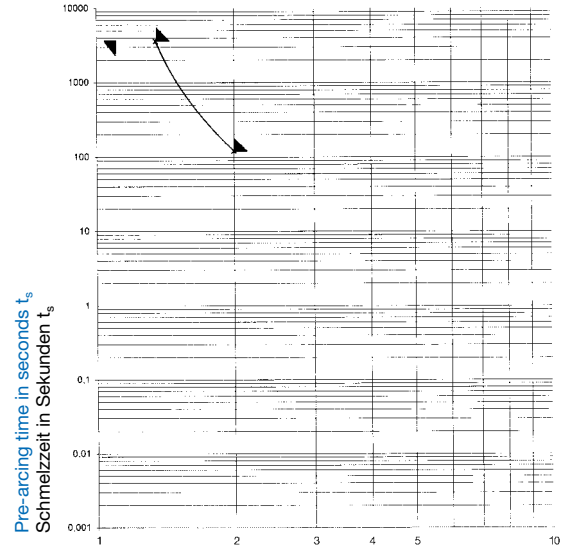
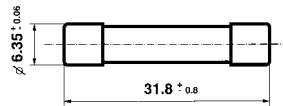
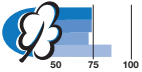

Multiple of rated current  $I_n$   
Vielfaches des Nennstromes  $I_n$

**Standards / Normen**

UL 248-14 (formerly / früher 198.G)  
CSA C22.2 No. 248.14 (formerly / früher 59.2 M)

**Approvals / Approbationen**

 UL  
 CSA  
Lists / Listen: NNO

**Pre-arcing time/current  
characteristic (at  $T_a$  23 °C)**

**Zeit-Strom-Charakteristik  
(bei  $T_u$  23 °C)**

Rated current $I_n$ / Nennstrom $I_n$	$n \cdot I_n$		
	$1,1 \cdot I_n$	$1,35 \cdot I_n$	$2 \cdot I_n$
	min.	max.	max.
0,125 – 16 A	1 h	1 h	120 s

**Technical data**

Weight 2,8 g

**Technische Daten**

Gewicht 2,8 g

Order No. / Bestell-Nr.	Rated current $I_n$ / Nennstrom $I_n$ / Nennspannung $U_n$	Breaking capacity / Ausschaltvermögen	Voltage drop / Spannungsfall at / bei $I_n$		Sustained power dissipation / Verlustleistung at / bei $1,1 \cdot I_n$	Pre-arcing $I^2t$ / Schmelz $I^2t$ at / bei $10 \cdot I_n$	Approvals / Approbationen			
			max. mV	max. W			CSA	UL	NNO	
7023.0110	0,125 A / 250 V	10 000 A / 125 V AC p.f. / $\cos \varphi$ 0,7–0,8	2450	0,42	4,3 · 10 <sup>-3</sup>	• • •	•	•	•	
7023.0330	0,160 A / 250 V		1600	0,34						1,1 · 10 <sup>-2</sup>
7023.0340	0,200 A / 250 V		1950	0,54						1,6 · 10 <sup>-2</sup>
7023.0120	0,250 A / 250 V		2100	0,72						2,7 · 10 <sup>-2</sup>
7023.0130	0,310 A / 250 V		2050	0,93						4,7 · 10 <sup>-2</sup>
7023.0140	0,400 A / 250 V		3150	1,55						5 · 10 <sup>-2</sup>
7023.0150	0,500 A / 250 V		2650	1,65						7 · 10 <sup>-2</sup>
7023.0160	0,630 A / 250 V		2450	1,9						2 · 10 <sup>-1</sup>
7023.0170	0,800 A / 250 V		2200	2,2						3,9 · 10 <sup>-1</sup>
7023.0180	1 A / 250 V		820	1,1						1,6 · 10 <sup>-1</sup>
7023.0190	1,25 A / 250 V	35 A / 250 V AC p.f. / $\cos \varphi$ 0,7–0,8	725	1,25	7 · 10 <sup>-2</sup>	• • •	•	•	•	
7023.0210	1,60 A / 250 V		445	0,93						8,3 · 10 <sup>-1</sup>
7023.0220	2 A / 250 V		405	1,1						1,5
7023.0230	2,50 A / 250 V		365	1,25						3,2
7023.0240	3,15 A / 250 V		320	1,35						6,5
7023.0250	4 A / 250 V		285	1,55						12
7023.0260	5 A / 250 V		255	1,7						26
7023.0270	6,3 A / 250 V		280	2,35						43
7023.0280	8 A / 250 V		95	0,96						10
7023.0290	10 A / 250 V		90	0,99						22
7023.0310	12,5 A / 250 V	10 000 A / 250 V AC p.f. / $\cos \varphi$ 0,7–0,8	100	1,5	20	• • •	•	•	•	
7023.0320	16 A / 250 V		115	2,30						92

**Miniature fuse-links  
Type 172 600**

super-time-lag TT  
high breaking capacity  
Ceramic tube

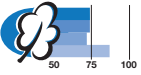

**G-Sicherungseinsätze  
Typ 172 600**

superträge TT  
grosses Ausschaltvermögen  
Keramikrohr

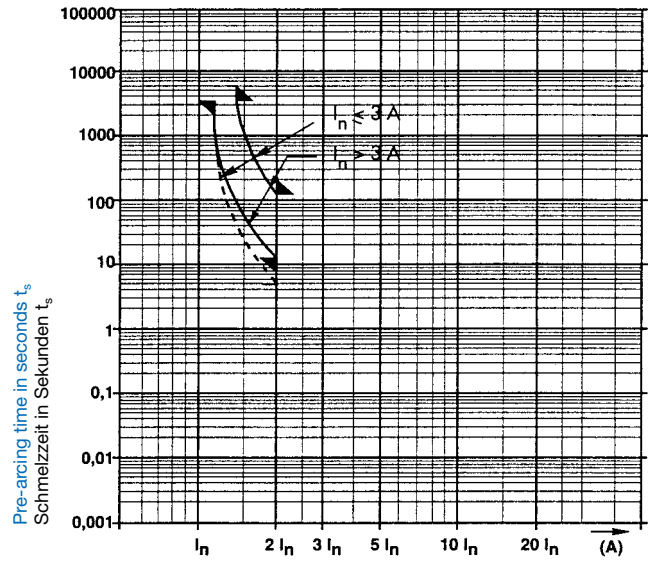
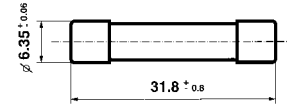

Multiple of rated current  $I_n$   
Vielfaches des Nennstromes  $I_n$

**Standards / Normen**

UL 248-14 (formerly / früher 198.G)

**Approvals / Approbationen**



Lists / Listen: NNO

**Pre-arcing time/current  
characteristic (at  $T_a$  23 °C)**

**Zeit-Strom-Charakteristik  
(bei  $T_u$  23 °C)**

Rated current $I_n$ / Nennstrom $I_n$	$1,1 \cdot I_n$		$1,35 \cdot I_n$		$2 \cdot I_n$	
	min.	max.	min.	max.	min.	max.
0,125 – 3 A	1 h	1 h	5 s	120 s		
4 – 20 A	1 h	1 h	12 s	120 s		

**Technical data**

Weight 2,5 g

**Technische Daten**

Gewicht 2,5 g

Order No. / Bestell-Nr.	Rated current $I_n$ / Rated voltage $U_n$ / Nennstrom $I_n$ / Nennspannung $U_n$	Breaking capacity / Ausschaltvermögen	Voltage drop / Spannungsfall at / bei $I_n$		Sustained power dissipation / Verlustleistung at / bei $1,1 \cdot I_n$		Pre-arcing $I^2t$ / Schmelz $I^2t$ at / bei $10 \cdot I_n$	Approvals / Approbationen
			max. mV	max. W	max. mV	max. W		
7033.8100	0,125 A / 250 V	10 000 A / 125 V AC p.f. / cos $\varphi$ 0,7-0,8 35 A / 250 V AC p.f. / cos $\varphi$ 0,7-0,8	3200	0,48	1120	0,23	1,8	UL UL NNO
7033.8110	0,160 A / 250 V		1200	0,29	1200	0,29	2,7	
7033.8160	0,200 A / 250 V		560	0,17	560	0,17	1,6	
7033.8120	0,250 A / 250 V		610	0,31	610	0,31	8,4	
7033.8130	0,400 A / 250 V		655	0,42	610	0,31	2,6	
7033.8050	0,500 A / 250 V		615	0,47	615	0,47	3	
7033.8140	0,600 A / 250 V		540	0,49	540	0,49	5	
7033.8060	0,700 A / 250 V		510	0,53	510	0,53	8,8	
7033.8070	0,800 A / 250 V		385	0,49	385	0,49	24	
7033.8150	1 A / 250 V		350	0,56	350	0,56	30	
7033.8080	1,25 A / 250 V	10 000 A / 125 V AC p.f. / cos $\varphi$ 0,7-0,8 200 A / 250 V AC p.f. / cos $\varphi$ 0,7-0,8	345	0,67	345	0,67	42	UL UL NNO
7033.8090	1,50 A / 250 V		315	0,65	315	0,65	47	
7043.8110	1,60 A / 250 V		270	0,7	270	0,7	84	
7043.8120	2 A / 250 V		255	0,85	255	0,85	170	
7043.8130	2,50 A / 250 V		240	1,15	240	1,15	200	
7043.8140	3 A / 250 V		168	0,86	168	0,86	600	
7043.8150	4 A / 250 V		150	0,9	150	0,9	690	
7043.8160	5 A / 250 V		166	1,36	166	1,36	1130	
7043.8170	6,30 A / 250 V		210	1,97	210	1,97	1360	
7043.8180	7 A / 250 V		10 000 A / 125 V AC p.f. / cos $\varphi$ 0,7-0,8 10 000 A / 125 V AC p.f. / cos $\varphi$ 0,7-0,8 1500 A / 250 V AC p.f. / cos $\varphi$ 0,7-0,8	150	1,52	150	1,52	
7043.8190	8 A / 125 V	165		2,15	165	2,15	38	
7043.8200	10 A / 125 V	150		2,5	150	2,5	70	
7043.8210	12,50 A / 250 V	175		3,7	175	3,7	330	
7043.8220	16 A / 250 V	168		4,5	168	4,5	1300	
7043.8230	20 A / 250 V							

**FUSES / SICHERUNGEN** NON RESETTABLE / NICHT RÜCKSTELLEND (1/4" x 1 1/4") 6,3 x 32 mm

**Miniature fuse-links  
Type 172582**

quick-acting F  
high breaking capacity  
Ceramic tube

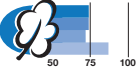

**G-Sicherungseinsätze  
Typ 172582**

flink F  
grosses Ausschaltvermögen  
Keramikrohr

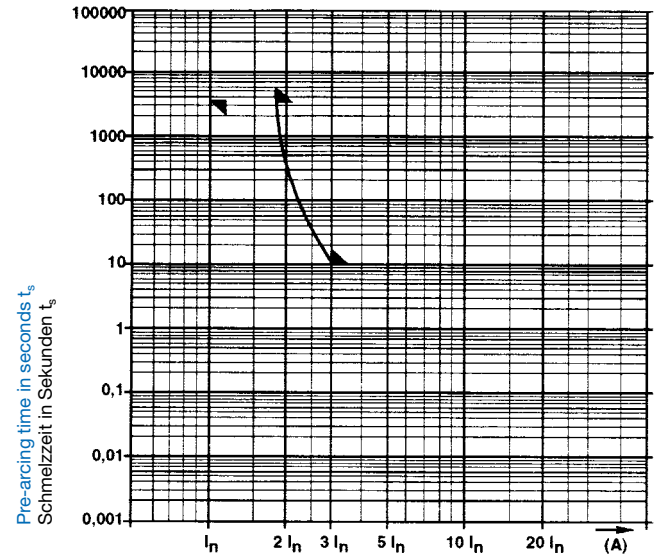
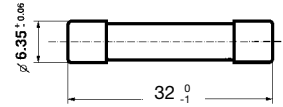

**Standards / Normen**

NF C 93-435 · Model HA39

**Approvals / Approbationen**

Lists / Listen: GAMT1, NNO

**Pre-arcing time/current  
characteristic (at T<sub>a</sub> 23 °C)**

**Zeit-Strom-Charakteristik  
(bei T<sub>u</sub> 23 °C)**

n · I <sub>n</sub>	1,1 · I <sub>n</sub>	1,7 · I <sub>n</sub>	3 · I <sub>n</sub>
Rated current I <sub>n</sub> / Nennstrom I <sub>n</sub>	min.	max.	max.
0,16 – 16 A	1 h	1 h	10 s

**Technical data**

Weight 3 g  
Permissible environmental temperature -40 °C / + 125 °C  
Derating 0,9 I<sub>n</sub> at 125 °C  
Climatic range 40 / 125 / 56  
Vibrations NF C 20-706 / IEC 60068-2-6  
10-55 Hz / 0,35 mm / 5 cycles  
Shocks NF C 20-727 / IEC 60068-2-27, 50 g  
Sinusoidal vibrations NF C 20-729 / IEC 60068-2-29, 40 g  
Salt mist NF C 20-711 / IEC 60068-2-11, 96 h

**Technische Daten**

Gewicht 3 g  
Zulässige Umgebungstemperatur -40 °C / + 125 °C  
Derating 0,9 I<sub>n</sub> bei 125 °C  
Klimakategorie 40 / 125 / 56  
Vibrationsbeständigkeit NF C 20-706 / IEC 60068-2-6  
10-55 Hz / 0,35 mm / 5 Perioden  
Schockbeständigkeit NF C 20-727 / IEC 60068-2-27, 50 g  
Sinusförm. Vibration NF C 20-729 / IEC 60068-2-29, 40 g  
Salznebel NF C 20-711 / IEC 60068-2-11, 96 h

Order No. / Bestell-Nr.	Rated current I <sub>n</sub> / Rated voltage U <sub>n</sub> / Nennstrom I <sub>n</sub> / Nennspannung U <sub>n</sub>	Breaking capacity / Ausschaltvermögen	Voltage drop /	Sustained	Pre-arcing	Approvals / Approbationen	
			Spannungsfall at / bei I <sub>n</sub>	power dissipation / Verlustleistung at / bei 1,1 · I <sub>n</sub>	time / Schmelzzeit at / bei 10 · I <sub>n</sub>		
			max. mV	max. W	A <sup>2</sup> s	NNO GAMT1	
7023.0790	0,160 A / 125/250 V	1000 A / 125 V DC  10 000 A / 250 V AC p.f. / cos φ 0,7-0,8	3450	0,77	2,1 · 10 <sup>-3</sup>	•	
7023.0810	0,250 A / 125/250 V		2650	0,87	7,5 · 10 <sup>-3</sup>	•	
7023.0830	0,400 A / 125/250 V					•	
7023.0850	0,630 A / 125/250 V			1200	1,05	4,4 · 10 <sup>-2</sup>	•
7023.0870	1 A / 125/250 V			880	1,17	1,6 · 10 <sup>-1</sup>	•
7023.0890	1,60 A / 125/250 V			610	1,35	7,4 · 10 <sup>-1</sup>	•
7023.0910	2,50 A / 125/250 V			350	1,15	4,8	•
7023.0930	4 A / 125/250 V			250	1,3	24	•
7023.0950	6,30 A / 125/250 V			360	3,1	27	•
7023.0960	8 A / 125/250 V			100	1,05	9,3	•
7023.0970	10 A / 125/250 V			105	1,35	34	•
7023.0980	12,50 A / 125/250 V			105	1,6	62	
7023.0990	16 A / 125/250 V			100	1,9	160	

**FUSES / SICHERUNGEN** NON RESETTABLE / NICHT RÜCKSTELLEND (1/4" x 1 1/4") 6,3 x 32 mm

**Miniature fuse-links**  
Types D8STTD, A12TD

time-lag T  
high breaking capacity  
Ceramic tube

**G-Sicherungseinsätze**  
Typen D8STTD, A12TD

träge T  
grosses Ausschaltvermögen  
Keramikrohr

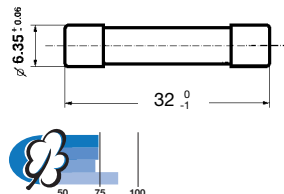

**Standards / Normen**

NF C 93-435 · Model HA24: Type / Typ D8STTD  
NF C 93-435 · Model HA25: Type / Typ A12TD

**Approvals / Approbationen**

 Qualification approval certificate of quality (CCQ) /  
Qualitätszertifikat (CCQ)

Lists / Listen: GAMT1, NNO

**Pre-arcing time/current characteristic (at T<sub>a</sub> 23 °C)**

**Zeit-Strom-Charakteristik (bei T<sub>u</sub> 23 °C)**

n · I <sub>n</sub> Rated current I <sub>n</sub> / Nennstrom I <sub>n</sub>	1,1 · I <sub>n</sub>		1,45 · I <sub>n</sub>		3 · I <sub>n</sub>		5 · I <sub>n</sub>	
	min.	max.	min.	max.	min.	max.	min.	max.
0,16 – 1,25 A	1 h	1 h	4 s	9 s	1 s	4 s		
1,6 – 16 A	1 h	1 h	1 s	10 s	0,3 s	3 s		

**Technical data**

Weight 2,8 g  
Climatic range 40 / 055 / 21 (575)  
Vibrations NF C 20-706 / IEC 60068-2-6  
10-55 Hz / 0,35 mm / 5 cycles  
Shocks NF C 20-727 / IEC 60068-2-27, 50 g  
Sinusoidal vibrations NF C 20-729 / IEC 60068-2-29, 40 g  
Salt mist NF C 20-711 / IEC 60068-2-11, 96 h

**Technische Daten**

Gewicht 2,8 g  
Klimakategorie 40 / 055 / 21 (575)  
Vibrationen NF C 20-706 / IEC 60068-2-6  
10-55 Hz / 0,35 mm / 5 Perioden  
Schockbeständigkeit NF C 20-727 / IEC 60068-2-27, 50 g  
Sinusförm. Vibration NF C 20-729 / IEC 60068-2-29, 40 g  
Salznebel NF C 20-711 / IEC 60068-2-11, 96 h

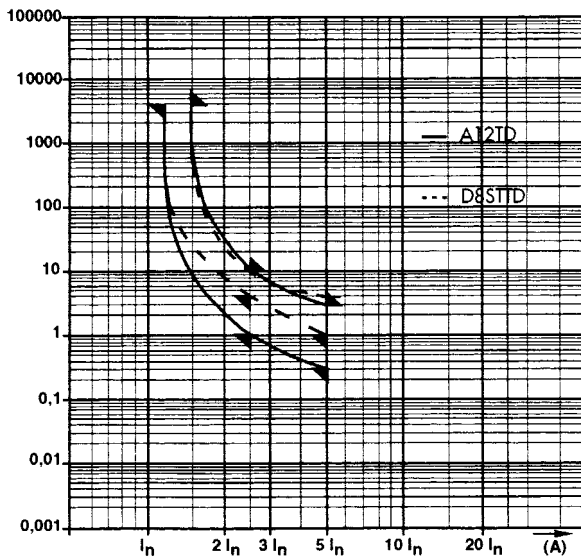

Multiple of rated current I<sub>n</sub>  
Vielfaches des Nennstromes I<sub>n</sub>

Types / Typen	Order No. / Bestell-Nr.	Rated current I <sub>n</sub> / Rated voltage U <sub>n</sub> / Nennstrom I <sub>n</sub> / Nennspannung U <sub>n</sub>	Breaking capacity / Ausschaltvermögen	Voltage drop / Spannungsfall at / bei I <sub>n</sub> max. mV	Sustained power dissipation / Verlustleist. at / bei 1,1 · I <sub>n</sub> max. W	Pre-arcing t <sub>s</sub> / Schmelz t <sub>s</sub> at / bei 10 · I <sub>n</sub> A <sup>2</sup> s	Approvals / Approbationen		
							CCQ	NNO	GAMT1
D8STTD	7035.7310	0,160 A / 125 V DC, AC / 220 V AC	5000 A / 125 V AC/DC p.f. / cos φ 0,3-0,4	1100	0,21	1,6	•	•	•
	7035.7320	0,200 A / 125 V DC, AC / 220 V AC		1100	0,26	1,9	•	•	•
	7035.7330	0,250 A / 125 V DC, AC / 220 V AC		570	0,18	1,4	•	•	•
	7035.7340	0,310 A / 125 V DC, AC / 220 V AC		500	0,19	7,2	•	•	•
	7035.7350	0,400 A / 125 V DC, AC / 220 V AC		505	0,25	6,3	•	•	•
	7035.7360	0,500 A / 125 V DC, AC / 220 V AC		450	0,28	1,9	•	•	•
	7035.7370	0,630 A / 125 V DC, AC / 220 V AC		460	0,37	11	•	•	•
	7035.7380	0,800 A / 125 V DC, AC / 220 V AC		320	0,32	12	•	•	•
	7035.7390	1 A / 125 V DC, AC / 220 V AC		405	0,51	15	•	•	•
	7035.7410	1,25 A / 125 V DC, AC / 220 V AC		315	0,5	23	•	•	•
A12TD	7043.6110	1,60 A / 125 V DC, AC / 220 V AC	5000 A / 125 V AC/DC p.f. / cos φ 0,3-0,4	240	0,48	47	•	•	•
	7043.6120	2 A / 125 V DC, AC / 220 V AC		210	0,53	85	•	•	•
	7043.6130	2,50 A / 125 V DC, AC / 220 V AC		165	0,52	87	•	•	•
	7043.6140	3,15 A / 125 V DC, AC / 220 V AC		500	1,9	131	•	•	•
	7043.6150	4 A / 125 V DC, AC / 220 V AC		180	0,92	590	•	•	•
	7043.6160	5 A / 125 V DC, AC / 220 V AC		190	1,15	320	•	•	•
	7043.6170	6,30 A / 125 V DC, AC / 220 V AC		140	1,15	1200	•	•	•
	7043.6180	8 A / 125 V DC, AC / 220 V AC		150	1,45	560	•	•	•
	7043.6490	10 A / 125 V DC, AC / 220 V AC		205	2,6	250	•	•	•
	7043.6210	12,50 A / 125 V DC, AC / 220 V AC		110	1,7	1200	•	•	•
7043.6220	16 A / 125 V DC, AC / 220 V AC	90	1,75	4500	•	•	•		

**Fuse kits**

 with miniature fuse-links  
5 x 20 mm

**Sicherungssortiments-  
Kasten**

 mit G-Sicherungseinsätzen  
5 x 20 mm



Order No. / Bestell-Nr.	Content / Inhalt	Types / Typen	Pieces / Stück	Rated current $I_n$ Rated voltage $U_n$ / Nennstrom $I_n$ Nennspannung $U_n$	Characteristic / Charakteristik	Breaking capacity / Ausschalt- vermögen	Technical data see page / Technische Daten siehe Seite
0034.9856		FSF 5 x 20 $I_n$ 0,1–10 A	15 15 15 15	100 mA 160 mA 200 mA 250 mA	250 V FSF: quick-acting F / flink F	low-breaking capacity / kleines Schalt- vermögen	85, 86
0034.9857		FST 5 x 20 $I_n$ 0,1–10 A	15 15 15 15 15 15 15 15 15 15 15 15 15	315 mA 400 mA 500 mA 630 mA 800 mA 1 A 1,25 A 1,6 A 2 A 2,5 A 4 A 5 A 6,3 A 10 A			FST: time-lag T / träge T
0034.9858	  	SPR SP 5 x 20 FST 5 x 20	30 15 30 30 30 15 15 15 15 15 15 15 15 15	500 mA 1 A 3,15 A 6,3 A 10 A 500 mA 1 A 1,25 A 1,6 A 2 A 2,5 A 3,15 A 6,3 A 10 A	250 V quick-acting F / flink F 250 V time-lag T / träge T	high-breaking capacity / grosses Schalt- vermögen low-breaking capacity / kleines Schalt- vermögen	on request / auf Anfrage 92 92 92 92 86 86 86 86 86 86 86 86 86
0034.9871	 	SP 5 x 20 SPT 5 x 20	10 10 10 10 10 10 10 10 10 10 10 10 10 10 10	800 mA 1 A 1,6 A 2 A 2,5 A 3,15 A 5 A 6,3 A 10 A 800 mA 1 A 1,6 A 2 A 2,5 A 3,15 A 5 A 6,3 A 10 A	250 V quick-acting F / flink F 250 V time-lag T / träge T	high-breaking capacity / grosses Schalt- vermögen	92 92 92 92 92 92 92 92 92 92 92 92 92 92 92 92 92 92

**Plug-on caps with pigtails**

for fuse-links  
5 x 20 mm and 6,3 x 32 mm

**Aufsteckkappen mit Drahtanschlüssen**

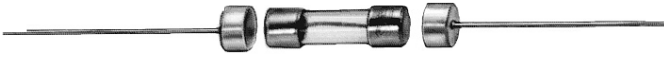
für Sicherungseinsätze  
5 x 20 mm und 6,3 x 32 mm



- for fuse-links 5 x 20 mm
- for fuse-links with rated current up to 8 A
- Material:
  - plug-on caps: brass silver-plated
  - pigtails: copper tin-plated

- für G-Sicherungseinsätze 5 x 20 mm
- für G-Sicherungseinsätze mit Nennströmen bis 8 A
- Material:
  - Aufsteckkappen: Messing versilbert
  - Drahtenden: Kupfer verzinkt

**Order No. / Bestell-Nr.**

1331.0044

Packaging unit 2000 pieces / Verpackungseinheit: 2000 Stück

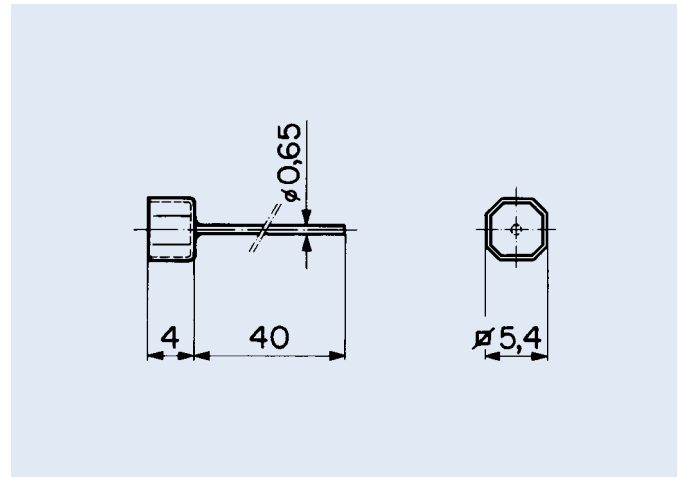

- for fuse-links 6,3 x 32 mm
- for fuse-links with rated current up to 8 A
- Material:
  - plug-on caps: brass silver-plated
  - pigtails: copper tin-plated

- für G-Sicherungseinsätze 6,3 x 32 mm
- für G-Sicherungseinsätze mit Nennströmen bis 8 A
- Material:
  - Aufsteckkappen: Messing versilbert
  - Drahtenden: Kupfer verzinkt

**Order No. / Bestell-Nr.**

1331.0045

Packaging unit 100 pieces / Verpackungseinheit: 100 Stück

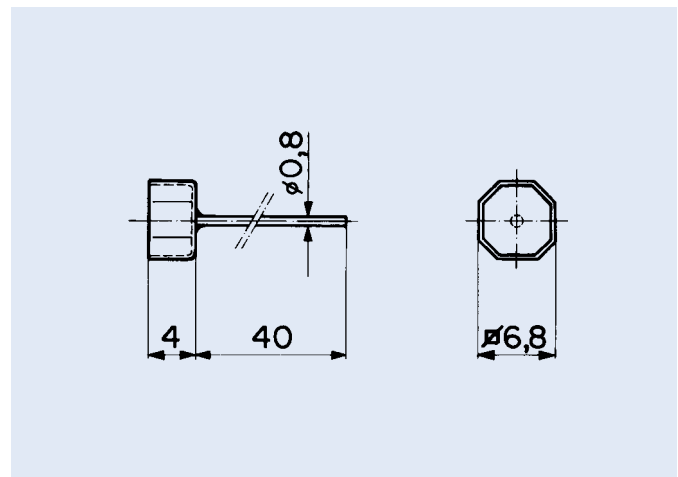

**Notes:**

- Leads mount as close as max. 2,5 mm from the cap.
- Bending degree shall be not too firm.
- For bending process, mechanical fixation shall be used between cap and bending point.

**Hinweise:**

- Biegestelle  $\geq$  2,5 mm von Kappe entfernt.
- Keine scharfkantige Biegung.
- Beim Biegen Anschluss zwischen Kappe und Biegestelle mechanisch fixieren.