



O/E/N 74H

AUTOMOTIVE POWER RELAY

FEATURES

- High performance
- 6.3mm flat terminals
- Suitable couplers available
- Optional sealing

APPLICATION

- Electric vehicles
- Battery chargers
- High voltage applications

TECHNICAL DATA FOR CONTACT SIDE :

Areas of Application	Resistive / Inductive / Head Lamp / Capacitive Load
Contact Configuration	: 1 Form A (1 NO), 1 Form C (1 CO)
Contact Material	: Silver Alloy
Contact Rating at 23°C - 36 VDC	: 25A/15A through NO & NC
48 VDC	: 20A/12A through NO & NC
72 VDC	: 15A/10A through NO & NC
110 VDC	: 7A/ 5A through NO & NC
Electrical Life in No. of Operations Min.	: 1×10^5
Mechanical Life in No. of Operations Min.	: 1×10^6
Contact Voltage Drop at 20A (Max.)	: 60mV
Maximum Switching Current @ 12.8 VDC For 3 Sec.	: 120A

GENERAL DATA FOR COIL SIDE

Nominal Coil Power	: 1.69W (Approx)
Operate Time	: 15 milli Seconds (Typ)
Release Time	: 15 milli Seconds (Typ)

OPERATING CONDITIONS

Ambient Temperature	: -40°C to +85°C
Dielectric Strength	
Between open contacts	: 500 VRMS
Between coil & contact	: 750 VRMS
Insulation Resistance	: 100 MegaOhms Min. at 500 VDC, 25°C RH 50
Vibration Resistance	: 10-2000Hz, 4.4g (Change in switching state not more than 10μS)
Shock Resistance	: 30g, 8mS (Change in switching state not more than 10μS)
Weight	: 65 gms Max.

WIRING DIAGRAM

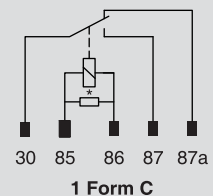
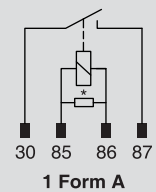

* Parallel resistor or diode optional

HOW TO ORDER

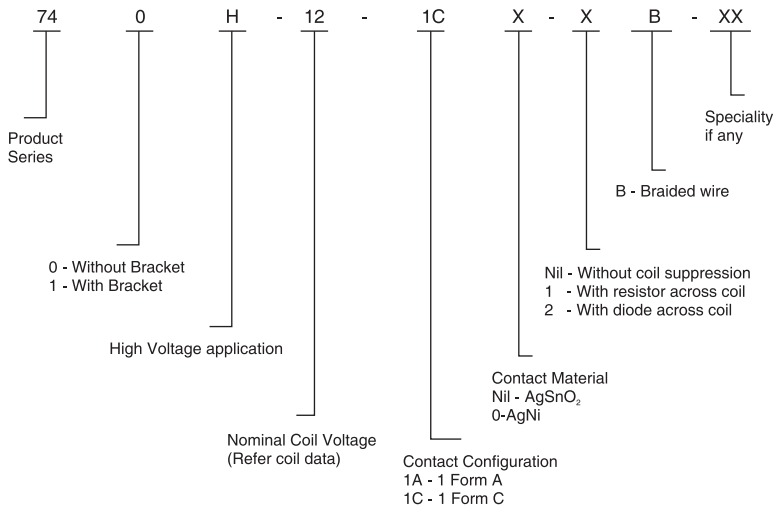

COIL DATA

Nominal Voltage VDC	**Pick-up Voltage VDC (Max)	Drop-out Voltage VDC (Min)	Coil Resistance Ohms (± 10%)
12	8.0	1.2	85
24	16.0	2.4	305

**Lower pick-up voltages available on request

DIMENSIONS

RELAY WITHOUT BRACKET

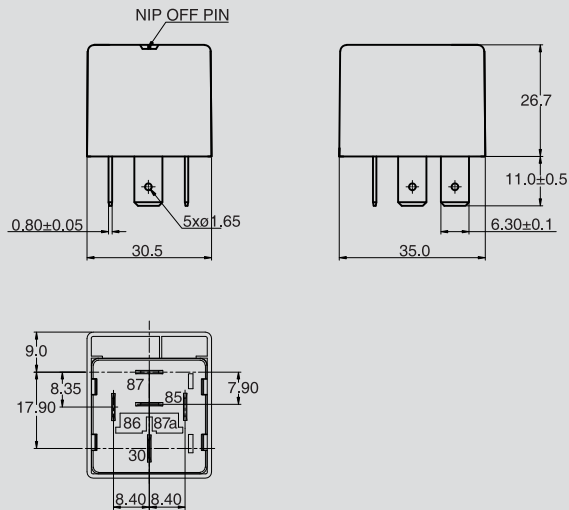

Note : Nip - off pin may be removed after soldering and cleaning for ventilation.

RELAY WITH BRACKET

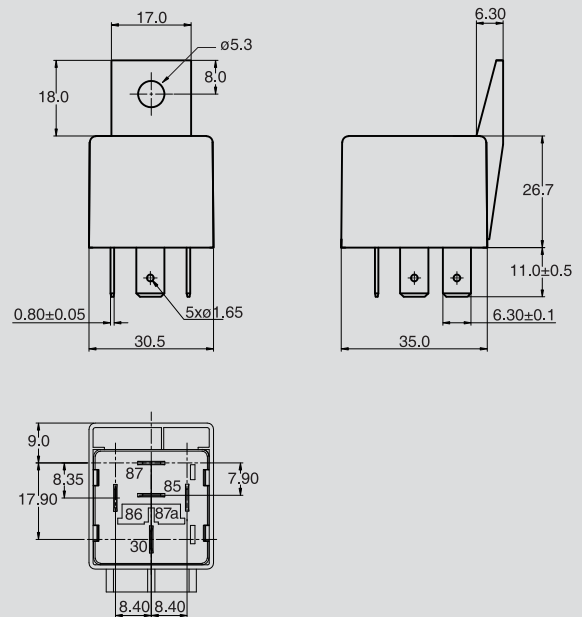

AVAILABLE ON REQUEST

- For custom solutions consult factory